



**RIGOL**

# MSO/DS9000 Series

---

Digital Oscilloscope

Quick Guide

Mar.2026



## **Guaranty and Declaration**

### **Copyright**

© 2026 RIGOL TECHNOLOGIES CO., LTD. All Rights Reserved.

### **Trademark Information**

RIGOL® is the trademark of RIGOL TECHNOLOGIES CO., LTD.

### **Software Version**

Software upgrade might change or add product features. Please acquire the latest software version from **RIGOL** website or contact **RIGOL** to upgrade the software.

### **Notices**

- RIGOL products are covered by P.R.C. and foreign patents, issued and pending.
- RIGOL reserves the right to modify or change parts of or all the specifications and pricing policies at the company's sole decision.
- Information in this publication replaces all previously released materials.
- Information in this publication is subject to change without notice.
- RIGOL shall not be liable for either incidental or consequential losses in connection with the furnishing, use, or performance of this manual, as well as any information contained.
- Any part of this document is forbidden to be copied, photocopied, or rearranged without prior written approval of RIGOL.

### **Product Certification**

RIGOL guarantees that this product conforms to the national and industrial standards in China as well as the ISO9001:2015 standard and the ISO14001:2015 standard. Other international standard conformance certifications are in progress.

### **Contact Us**

If you have any problem or requirement when using our products or this manual, please contact RIGOL.

E-mail: [service@rigol.com](mailto:service@rigol.com)

Website: <http://www.rigol.com>

# 1 Safety Requirement

## 1.1 General Safety Summary

Please review the following safety precautions carefully before putting the instrument into operation so as to avoid any personal injury or damage to the instrument and any product connected to it. To prevent potential hazards, please follow the instructions specified in this manual to use the instrument properly.

- |   |  |    |  |
|---|--|----|--|
| 1 | Only the exclusive power cord designed for the instrument and authorized for use within the destination country could be used. | 9  | Do not operate the instrument with suspected failures. |
| 2 | Ensure that the instrument is safely grounded.   | 10 | Provide adequate ventilation.                          |
| 3 | Observe all terminal ratings.  | 11 | Do not operate in wet conditions.                      |
| 4 | Use proper overvoltage protection.   | 12 | Do not operate in an explosive atmosphere.             |
| 5 | Do not operate without covers.   | 13 | Keep instrument surfaces clean and dry.                |
| 6 | Do not insert objects into the air outlet.   | 14 | Prevent electrostatic impact.                          |
| 7 | Use the proper fuse.   | 15 | Handle with caution.                                   |
| 8 | Avoid circuit or wire exposure.  |    |  |



### WARNING

Equipment meeting Class A requirements may not offer adequate protection to broadcast services within residential environment.

## 1.2 Safety Notices and Symbols

Safety Notices in this Manual:



### WARNING

Indicates a potentially hazardous situation or practice which, if not avoided, will result in serious injury or death.



### CAUTION

Indicates a potentially hazardous situation or practice which, if not avoided, could result in damage to the product or loss of important data.

**Safety Notices on the Product:**

- **DANGER**

It calls attention to an operation, if not correctly performed, could result in injury or hazard immediately.

- **WARNING**

It calls attention to an operation, if not correctly performed, could result in potential injury or hazard.

- **CAUTION**

It calls attention to an operation, if not correctly performed, could result in damage to the product or other devices connected to the product.

**Safety Symbols on the Product:**

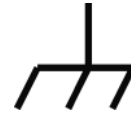
**Hazardous Voltage**



**Safety Warning**



**Protective Earth Terminal**



**Chassis Ground**



**Test Ground**

## 1.3 Measurement Category

**Measurement Category**

This instrument can make measurements in Measurement Category I.

**WARNING**

**This instrument can only be used for measurements within its specified measurement categories.**

**Measurement Category Definitions**

- **Measurement category I** is for measurements performed on circuits not directly connected to MAINS. Examples are measurements on circuits not derived from MAINS, and specially protected (internal) MAINS derived circuits. In the latter case, transient stresses are variable. Thus, you must know the transient withstand capability of the equipment.
- **Measurement category II** is for measurements performed on circuits directly connected to low voltage installation. Examples are measurements on household appliances, portable tools and similar equipment.
- **Measurement category III** is for measurements performed in the building installation. Examples are measurements on distribution boards, circuit-breakers, wiring (including cables, bus-bars, junction boxes, switches and socket-outlets) in the fixed installation, and equipment for industrial use and some other

equipment. For example, stationary motors with permanent connection to a fixed installation.

- **Measurement category IV** is for measurements performed at the source of a low-voltage installation. Examples are electricity meters and measurements on primary overcurrent protection devices and ripple control units.

## 1.4 Ventilation Requirement

This instrument uses a fan to force cooling. Please make sure that the air inlet and outlet areas are free from obstructions and have free air. When using the instrument in a bench-top or rack setting, provide at least 10 cm clearance beside, above and behind the instrument for adequate ventilation.



### CAUTION

**Inadequate ventilation may cause an increase of temperature in the instrument, which would cause damage to the instrument. So please keep the instrument well ventilated and inspect the air outlet and the fan regularly.**

## 1.5 Working Environment

### Temperature

Operating: -10°C to +50°C

Non-operating: -30°C to +60°C

### Humidity

Operating: Below +50°C: 90% RH (without condensation)

Non-operating: Below +65°C: 90% RH (without condensation)



### WARNING

**To avoid short circuit inside the instrument or electric shock, never operate the instrument in a humid environment.**

### Altitude

- **Operating:** below 3 km
- **Non-operating:** below 15 km

### Protection level against electric shock

ESD ±8kV

### Installation (Overvoltage) Category

This product is powered by mains conforming to installation (overvoltage) category II.

**WARNING**

Ensure that no overvoltage (such as that caused by a bolt of lightning) can reach the product. Otherwise, the operator might be exposed to the danger of an electric shock.

**Installation (Overvoltage) Category Definitions**

Installation (overvoltage) category I refers to signal level which is applicable to equipment measurement terminals connected to the source circuit. Among these terminals, precautions are done to limit the transient voltage to a low level.

Installation (overvoltage) category II refers to the local power distribution level which is applicable to equipment connected to the AC line (AC power).

**Pollution Degree**

Pollution Degree 2

**Pollution Degree Definition**

- **Pollution Degree 1:** No pollution or only dry, nonconductive pollution occurs. The pollution has no effect. For example, a clean room or air-conditioned office environment.
- **Pollution Degree 2:** Normally only nonconductive pollution occurs. Temporary conductivity caused by condensation is to be expected. For example, indoor environment.
- **Pollution Degree 3:** Conductive pollution or dry nonconductive pollution that becomes conductive due to condensation occurs. For example, sheltered outdoor environment.
- **Pollution Degree 4:** The pollution generates persistent conductivity caused by conductive dust, rain, or snow. For example, outdoor areas.

**Safety Class**

Class 1 – Grounded Product

## 1.6 Care and Cleaning

**Care**

Do not store or leave the instrument where it may be exposed to direct sunlight for long periods of time.

**Cleaning**

Clean the instrument regularly according to its operating conditions.

1. Disconnect the instrument from all power sources.

2. Clean the external surfaces of the instrument with a soft cloth dampened with mild detergent or water. Avoid having any water or other objects into the chassis via the heat dissipation hole. When cleaning the LCD, take care to avoid scarifying it.

**CAUTION**

To avoid damage to the instrument, do not expose it to caustic liquids.

**WARNING**

To avoid short-circuit resulting from moisture or personal injuries, ensure that the instrument is completely dry before connecting it to the power supply.

## 1.7 Environmental Considerations

The following symbol indicates that this product complies with the WEEE Directive 2012/19/EU.



The equipment may contain substances that could be harmful to the environment or human health. To avoid the release of such substances into the environment and avoid harm to human health, we recommend you to recycle this product appropriately to ensure that most materials are reused or recycled properly. Please contact your local authorities for disposal or recycling information.

You can click on the following link <https://www.rigol.com/intl/services/environmental-protection-statement.html> to download the latest version of the RoHS&WEEE certification file.

## 2 Document Overview

This manual gives you a quick overview of the front and rear panel, user interface as well as basic operation methods of MSO/DS9000 series.

### TIP

For the latest version of this manual, download it from the official website of RIGOL (<http://www.rigol.com>).

### Publication Number


QGA40101-1110

### Software Version

Software upgrade might change or add product features. Please acquire the latest version of the manual from RIGOL website or contact RIGOL to upgrade the software.

### Format Conventions in this Manual

#### 1. Key


The front panel key is denoted by the menu key icon. For example,  indicates the "DEFAULT" key.

#### 2. Menu

The menu item is denoted by the format of "Menu Name (Bold) + Character Shading" in the manual. For example, **Setup** indicates the "Setup" sub-menu under the "Utility" function menu. You can click or tap **Setup** to access the "Setup" menu.

#### 3. Operation Procedures

The next step of the operation is denoted by ">" in the manual. For example, 

> **Storage** indicates that first clicking or tapping the icon , then clicking or tapping **Storage**.

4. The front/rear panel connector is denoted by "Brackets + Connector Name (Bold)", for example, **[AUX OUT]**.

### Content Conventions in this Manual

MSO/DS9000 series digital oscilloscope includes the following models, which support different combinations of features. Unless otherwise specified, this manual takes DS9404 as an example to illustrate the functions and operation methods of MSO/DS9000 series oscilloscope.

<b>Model</b>	<b>Max. Analog Bandwidth</b>	<b>Analog Channels</b>	<b>Function/ Arbitrary Waveform Generator Channels</b>	<b>Digital Channels</b>	<b>Bode Plot</b>
DS9202	2 GHz	2	-	-	-
DS9204	2.5 GHz	4	-	-	-
DS9404	4 GHz	4	-	-	-
DS9604	6 GHz	4	-	-	-
MSO9402	4 GHz	2	2	16	Supported

## 3 General Inspection

---

### 1. Inspect the packaging

If the packaging has been damaged, do not dispose the damaged packaging or cushioning materials until the shipment has been checked for completeness and has passed both electrical and mechanical tests.

The consigner or carrier shall be liable for the damage to the instrument resulting from shipment. RIGOL would not be responsible for free maintenance/rework or replacement of the instrument.

### 2. Inspect the instrument

In case of any mechanical damage, missing parts, or failure in passing the electrical and mechanical tests, contact your RIGOL sales representative.

### 3. Check the accessories

Please check the accessories according to the packing lists. If the accessories are damaged or incomplete, please contact your RIGOL sales representative.

### Recommended Calibration Interval

RIGOL suggests that the instrument should be calibrated every 18 months.

## 4 Product Overview

MSO/DS9000 series digital oscilloscope gives full play to the excellent performance of RIGOL technology platform, achieving a max. sample rate of 20 GSa/s and 6 GHz real-time bandwidth. In addition to the improvement of hardware specifications, the MSO/DS9000 series digital oscilloscope also has many user-friendly designs to ensure high-quality user experience.

### 4.1 Appearance and Dimensions

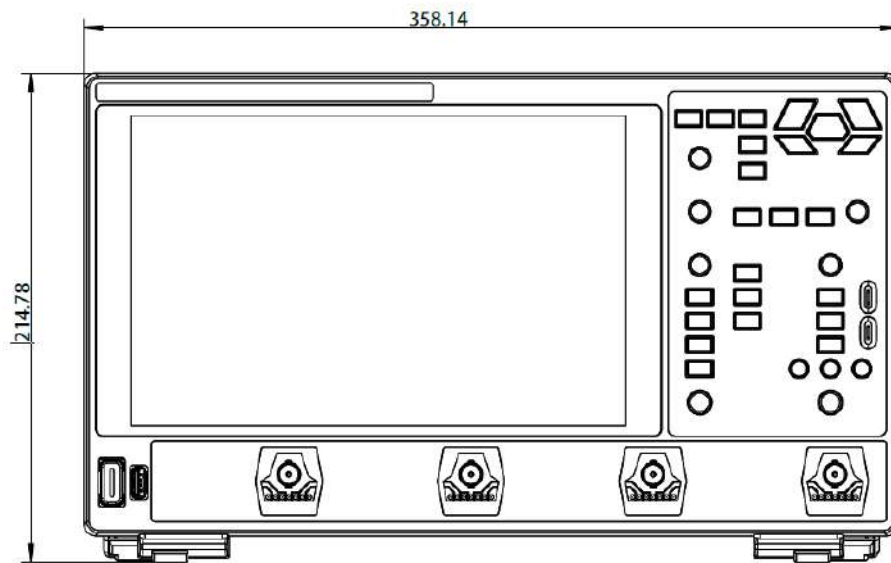


Figure 4.1 Front View

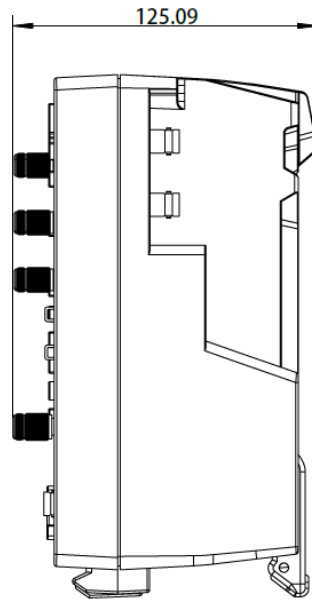


Figure 4.2 Side View

## 4.2 Front Panel Overview

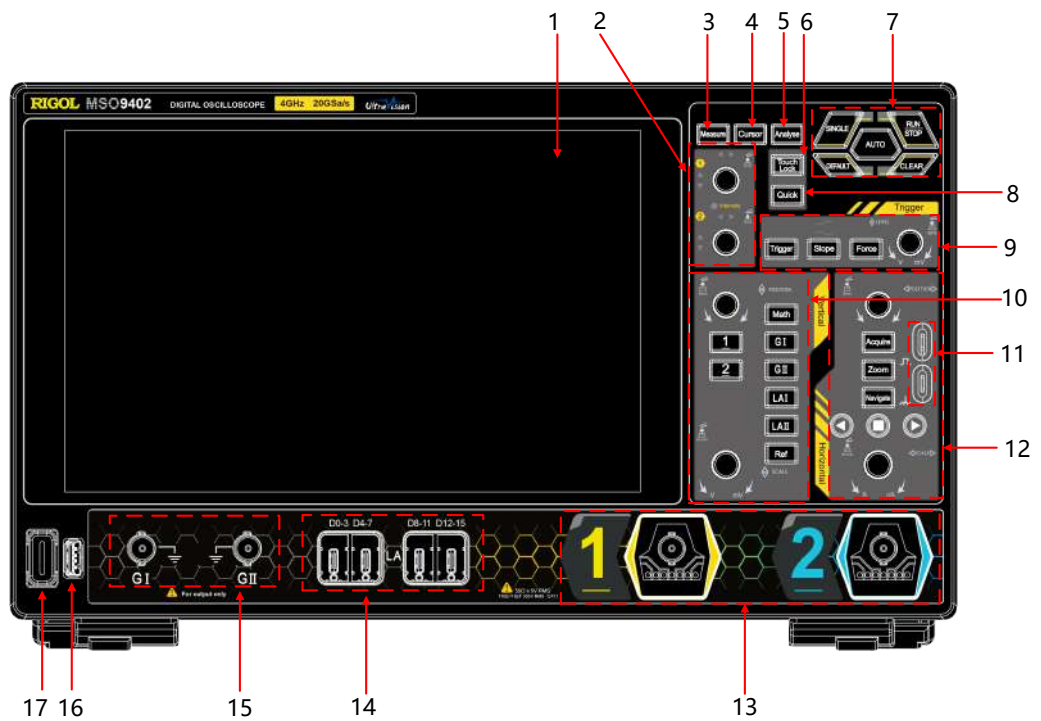
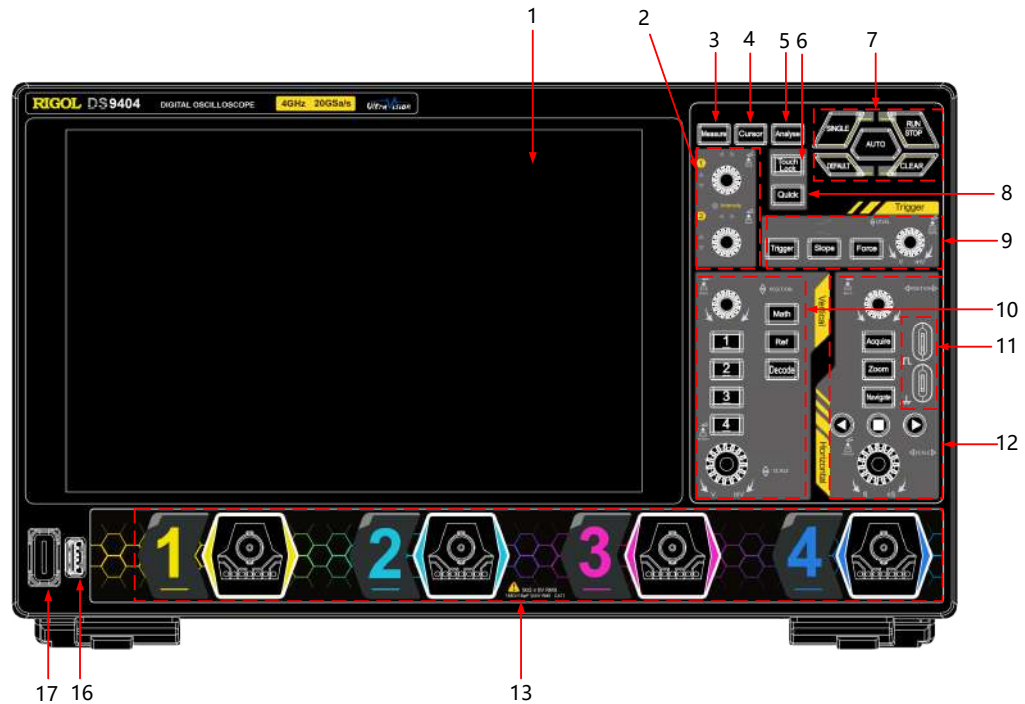


Figure 4.3 MSO9402 Front Panel



**Figure 4.4 DS9404 Front Panel**

1	10.1" Capacitive Touch Screen	10	Vertical Control Area
2	Multifunction Knobs	11	Probe Compensation Signal Output Terminal/Ground Terminal
3	Measure Key	12	Horizontal Control Area
4	Cursor Key	13	Analog Channel Input Terminals
5	Analyse Key	14	Digital Channel Input (Type-C Interface) <sup>[1]</sup>
6	Touch Lock Key	15	Two-Channel Function/Arbitrary Waveform Generator Output Terminal <sup>[2]</sup>
7	Common Tools Keys	16	USB HOST Interface
8	Quick Action Key (Self-defined function)	17	Power Key
9	Trigger Control Area		

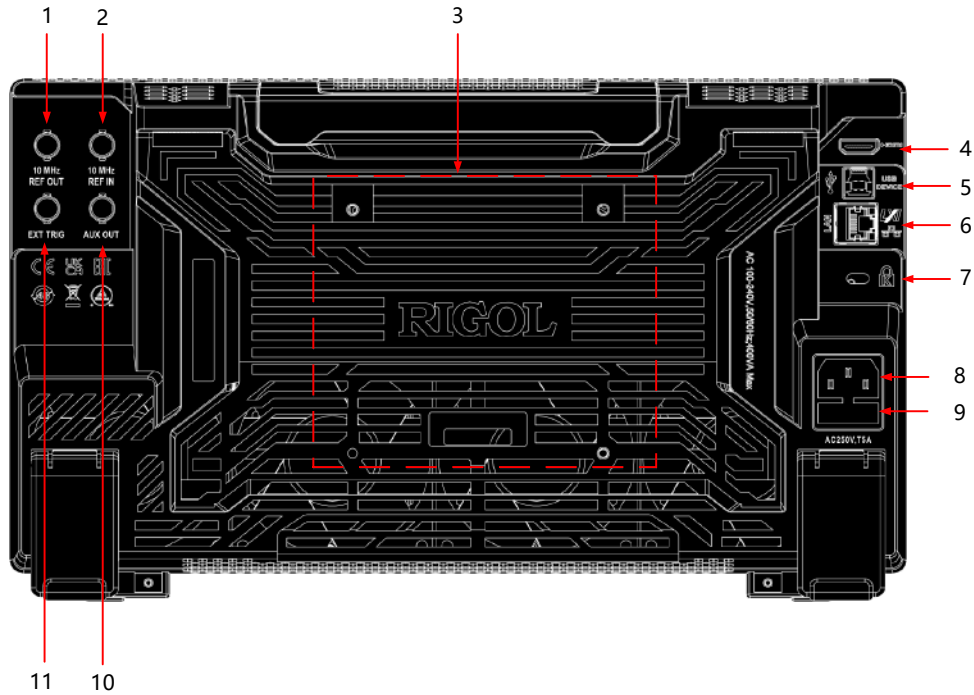
**NOTE**

[1]: Digital channels are only available for MSO9402.

[2]: Function/arbitrary waveform generator is available for MSO9402.



### 4.3 Rear Panel Overview



**Figure 4.5 Rear Panel**

- 1            10 MHz Reference Clock Output Connector
- 2            10 MHz Reference Clock Input Connector
- 3            Mounting Hole
- 4            HDMI Output Connector
- 5            USB DEVICE Port
- 6            LAN Interface
- 7            Security Lock Hole
- 8            AC Power Cord Connector
- 9            Fuse
- 10          Trigger Output Connector
- 11          External Trigger Input Connector

## 4.4 User Interface Overview

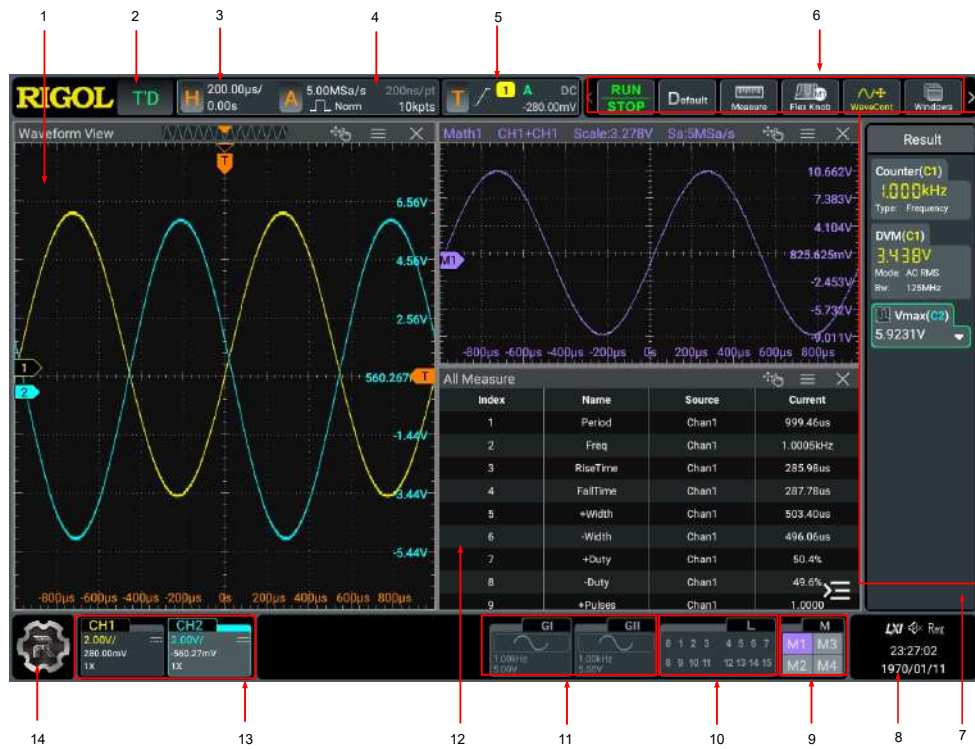


Figure 4.6 MSO9402 User Interface

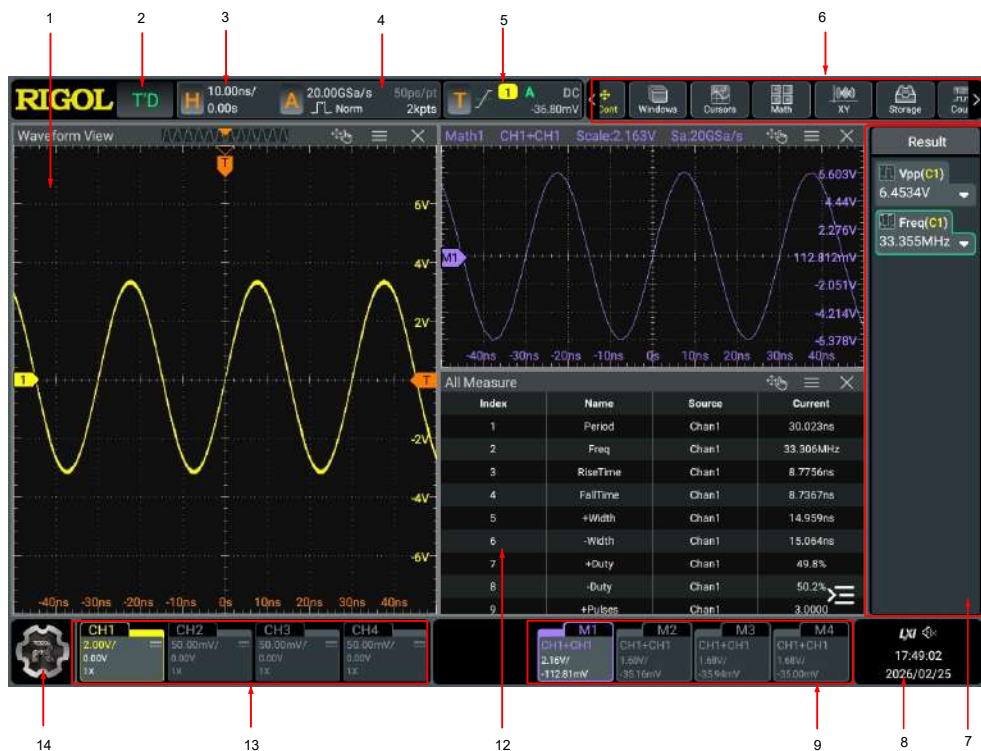


Figure 4.7 DS9404 User Interface

1	Waveform View	8	Notification Area
2	Operating Status Label	9	Math Operation Label
3	Horizontal Time Base & Horizontal Position Label	10	Digital Channel Label <sup>[1]</sup>
4	Sample Rate & Memory Depth Label	11	Function/Arbitrary Waveform Generator Channel <sup>[2]</sup> Label
5	Trigger Label	12	Multi-pane Windowing Display Area
6	Function Icon Bar	13	Analog Channel Label
7	Result List	14	Function Navigation Icon

**NOTE**

[1]: Digital channels are only available for MSO9402.

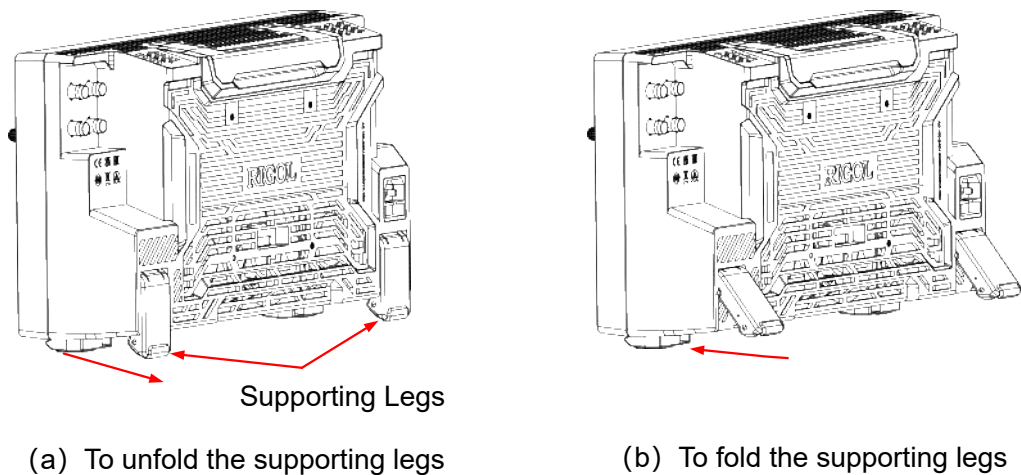
[2]: Function/arbitrary waveform generator is available for MSO9402.



## 5 To Prepare for Use

### 5.1 To Adjust the Supporting Legs

Adjust the supporting legs properly to use them as stands to tilt the oscilloscope upwards for stable placement of the oscilloscope as well as better operation and observation. You can also fold the supporting legs when the instrument is not in use for easier storage or shipment, as shown in the figure below.



**Figure 5.1 Adjust the Supporting Legs**

### 5.2 To Connect to AC Power

The AC power requirements of the oscilloscope are 100-240 V, 50/60 Hz, 400VA Max. Please use the power cord provided in the accessories to connect the oscilloscope to the AC power source, as shown in the figure below.

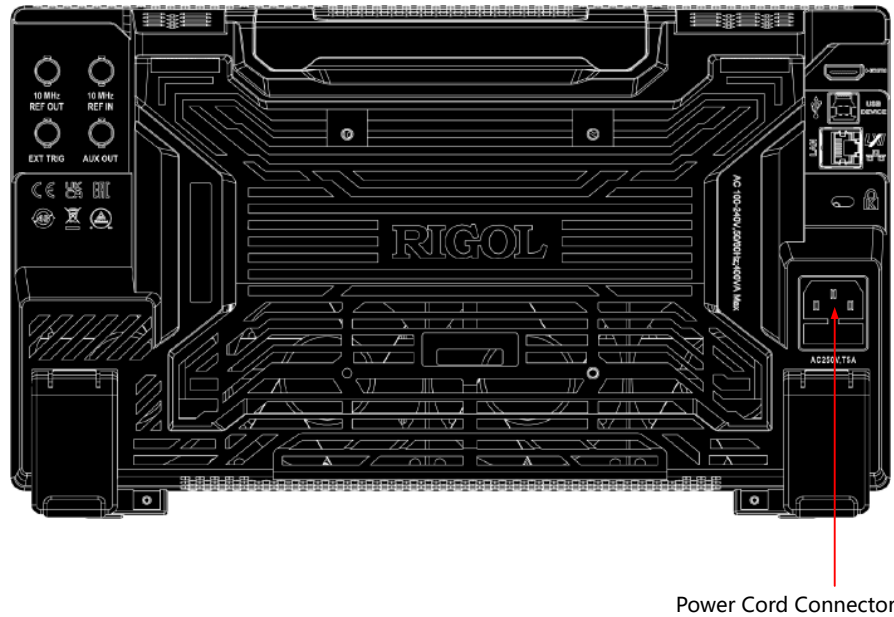


Figure 5.2 Connect to AC Power



#### WARNING


To avoid electric shock, ensure that the instrument is correctly grounded.







#### TIP

When the oscilloscope equipped with the battery pack is connected to the AC power, the oscilloscope is energized and the AC power can also charge the battery pack.

## 5.3 Turn-on Checkout


After the instrument is connected to the power source, press the power key  at the lower-left corner of the front panel to power on the instrument. During the start-up process, the instrument performs a series of self-tests. After the self-test, the splash screen is displayed.

- **Restart:** Click or tap  > **Power** > **Restart** to restart the instrument.
- **Shutdown:**
  - Click or tap  > **Power** > **Shutdown** to shut down the instrument.
  - Press , and in the displayed power menu, click or tap **Shutdown** to shut down the instrument.
  - Press  twice to directly shut down the instrument.


- Press **0** for three seconds to directly shut down the instrument.



#### TIP

You can also click or tap  > **Utility** > **Setup**, then select "Switch On" under the Power status menu. After the setting, the instrument powers on once connected to power.

## 5.4 To Set the System Language

This oscilloscope supports multiple languages. You can click or tap  > **Utility** > **Setup** > **Language** to select the system language.

## 5.5 To Connect the Probe

RIGOL provides the passive probe, the active probe, and the logic probe for MSO/DS9000 series. For specific probe models, please refer to *MSO/DS9000 Data Sheet*. For detailed technical information of the probes, please refer to the corresponding Probe User Guide.

### Connect the Passive Probe

1. Connect the BNC terminal of the probe to an analog channel input terminal of the oscilloscope on the front panel as shown in the figure below.
2. Connect the ground alligator clip or spring of the probe to the circuit ground terminal, and then connect the probe tip to the circuit point to be tested.

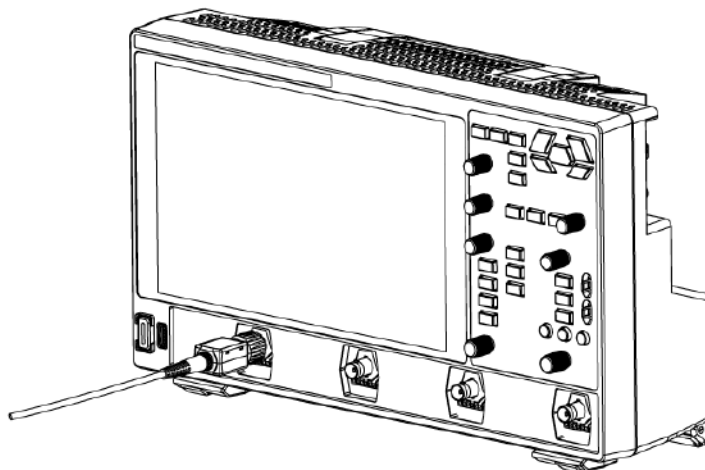
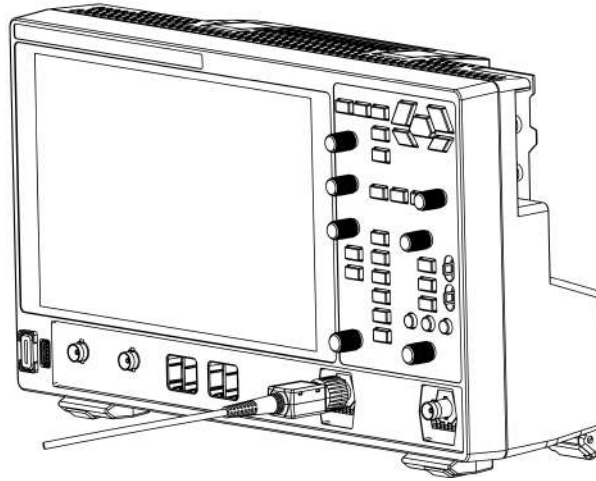


Figure 5.3 Connect the Passive Probe (DS Model)



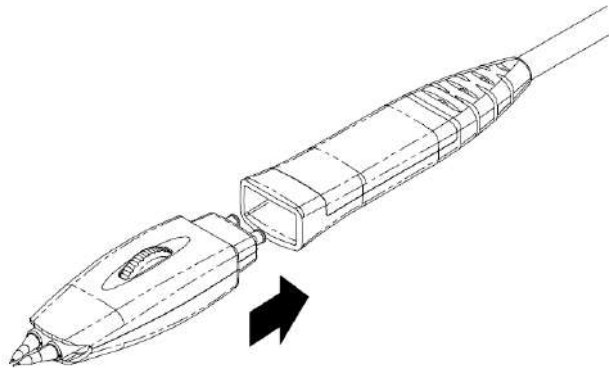
**Figure 5.4 Connect the Passive Probe (MSO Model)**

After you connect the passive probe, check the probe function and probe compensation adjustment before making measurements. For details, refer to *Function Inspection* and *Probe Compensation*.

#### **Connect the Active Probe**

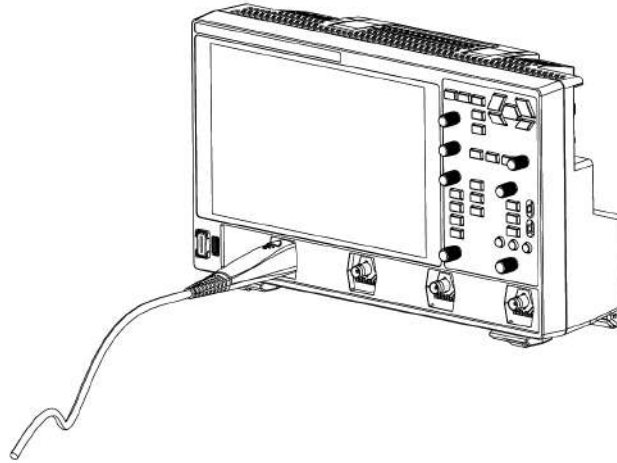
Take PVA8700 (active differential probe) as an example.

1. Connect the probe head to the preamp of the active probe, as shown in the figure below.

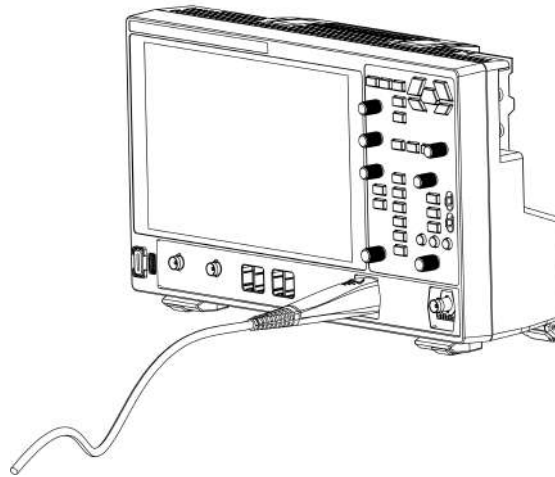


**Figure 5.5 Connect the Probe Head to the PA of the Active Probe**

2. Connect the other end of the preamp to an analog channel input terminal of the oscilloscope on the front panel, as shown in the figure below. Note that you need to push the probe to the due position to lock it firmly.



**Figure 5.6 Connect the Active Probe (DS Model)**



**Figure 5.7 Connect the Active Probe (MSO Model)**

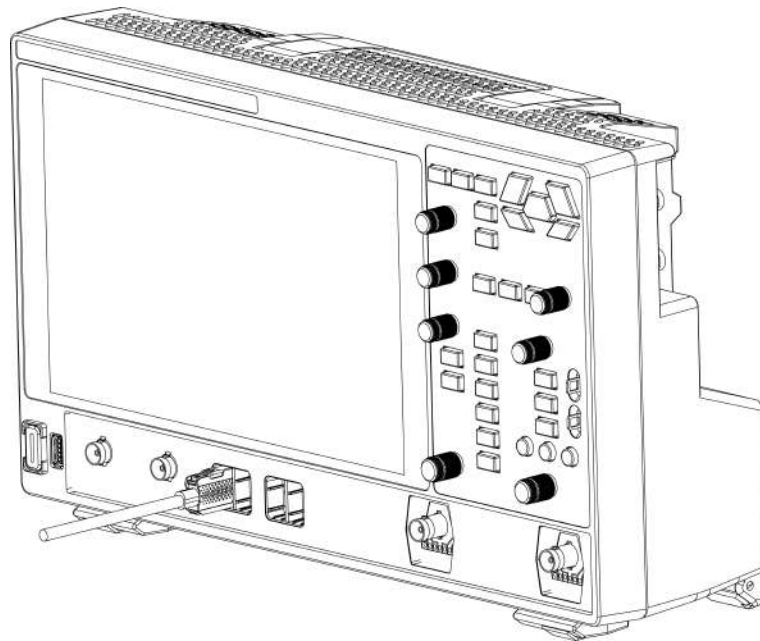
3. Use the probe's auxiliary device to connect the probe head to the circuit under test. For detailed information of the probes, please refer to User Guide for PVA8000 Series Active Probe.

After connecting the active probe, you can perform probe calibration and offset voltage adjustment if necessary. For details, refer to descriptions about the active probe in User Guide.

#### **Connect the Logic Probe (MSO Model)**

1. Connect the output terminal of the logic probe to the digital channel input terminal on the front panel of the oscilloscope in the correct direction, as shown in the figure below.

2. Connect the other terminal of the logic probe to the signal terminal under test. MSO9402 provides the optional PLA3204 active logic probe. For details, refer to User Guide for PLA3204 Logic Probe.




**Figure 5.8 Connect the Logic Probe**

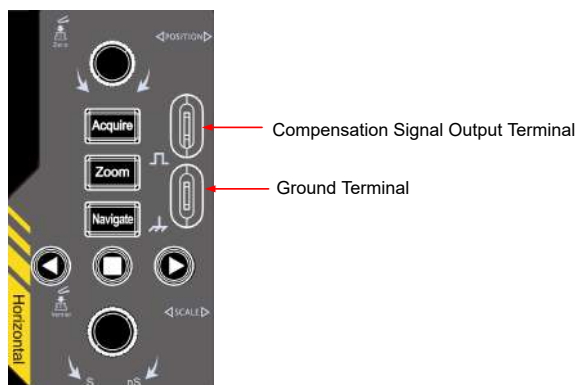


**TIP**


- For ground connection of high-speed signals, the ground lead shall be connected to the ground test point near the measured signal, and the ground lead shall be kept as short as possible.
- If there are a large number of input signal channels, please connect each signal to a ground signal as far as possible. If there is only one ground test point, connect all ground leads on the probe to the ground test point.
- Set a proper threshold value of the logic probe according to the actual level range of the measured signal, and keep it in the middle of the level range.

## 5.6 Function Inspection

1. Press the front-panel  and a prompt message "Restore default settings?" is displayed. Click or tap **OK** to restore the instrument to its factory default settings.
2. Connect the ground alligator clip of the probe to the "Ground Terminal" as shown in [Figure 5.9](#).
3. Use the probe to connect the input terminal of CH1 of the oscilloscope and the "Compensation Signal Output Terminal" of the probe, as shown in [Figure 5.9](#).



**Figure 5.9 Use the Compensation Signal**

4. Set the probe ratio based on the attenuation of the probe, and then click  > **Auto**.
5. Observe the waveform on the display. In normal condition, you should see a square waveform as shown in the figure below.



**Figure 5.10 Square Waveform Signal**

6. Use the same method to test other channels. If the square waveforms actually shown do not match that in the figure above, please perform *Probe Compensation* introduced in the next section. If no waveform is displayed on the screen, perform the above steps again.



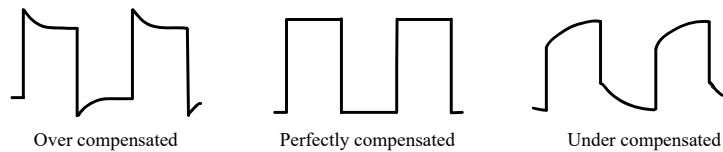
**WARNING**

To avoid electric shock when using the probe, please make sure that the insulated wire of the probe is in good condition. Do not touch the metallic part of the probe when the probe is connected to high voltage source.

## 5.7 Probe Compensation

When the probes are used for the first time, you should compensate the probes to make them match the input channels of the oscilloscope. Non-compensated or poorly compensated probes may cause measurement inaccuracy or errors. The probe compensation procedures are as follows:

1. Perform Step 1, 2, 3 and 4 in *Function Inspection*.
2. Check the displayed waveforms and compare them with the waveforms shown in the figure below.



**Figure 5.11 Probe Compensation**

3. Use the probe compensation adjustment tool provided in the accessories to adjust the low-frequency compensation adjustment hole on the probe until the displayed waveform is consistent with the "Perfectly compensated" waveform shown in the figure above.

## 6 Touch Screen Gestures

---

The instrument provides a super large capacitive touch screen, which is convenient for users to operate and make configurations. It has strong waveform display capacity and excellent user experience. It features great convenience, high flexibility, and great sensitivity. The actions supported by the touch screen controls include tapping, pinching&stretching, and dragging.

### 6.1 Tap

---

Use one finger to tap the symbol or characters on the screen slightly, as shown in *Figure 6.1*. With the Tap gesture, you can perform the following operations:

- Tap the menu displayed on the screen to operate on the menu.
- Tap the function navigation icon at the lower-left corner of the touch screen to enable the function navigation.
- Tap the displayed numeric keypad to set the parameters.
- Tap the virtual keypad to set the label name and the filename.
- Tap the close button at the upper-right corner of the message box to close the prompt window.
- Tap other windows on the touch screen and operate on the windows.



**Figure 6.1 Tap Gesture**

### 6.2 Drag

---

Use one finger to select the object, and then drag the object to a destination place, as shown in the figure below. With the drag gesture, you can perform the following operation:

- Drag the waveform to change its position or scale.
- Drag the window controls to change the position of the window (e.g. numeric keypad).
- Drag the cursor to move the cursor.
- Drag the trigger cursor to change the trigger level.
- In multi-window display, drag one of the displayed windows to change its position on the display.

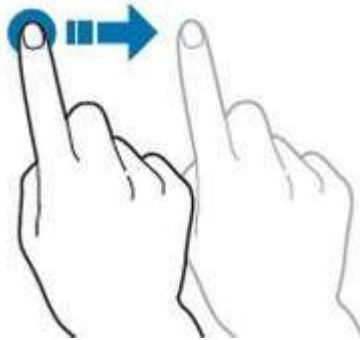


Figure 6.2 Drag Gesture

## 6.3 Pinch&Stretch

Pinch or stretch two points on the screen with two fingers to zoom in or out the waveform. To zoom in the waveform, first pinch the two fingers and then stretch the fingers; to zoom out the waveform, first stretch the two fingers, and then pinch the fingers together, as shown in the figure below. With the pinch&stretch gesture, you can perform the following operation:

- Pinching&stretching in the horizontal direction can adjust the horizontal time base of the waveform.
- Pinching&stretching in the vertical direction can adjust the vertical scale of the waveform.




**Figure 6.3 Pinch&Stretch Gesture**

## 7 To Use the Built-in Help System

---

The built-in help file provides information about the functions and menu

introductions of the instrument. Click or tap  > **Help** to enter the help system.

In the help system, you can get its help information by clicking on or tapping the link for the specified chapter.

## 8 Parameter Setting Method

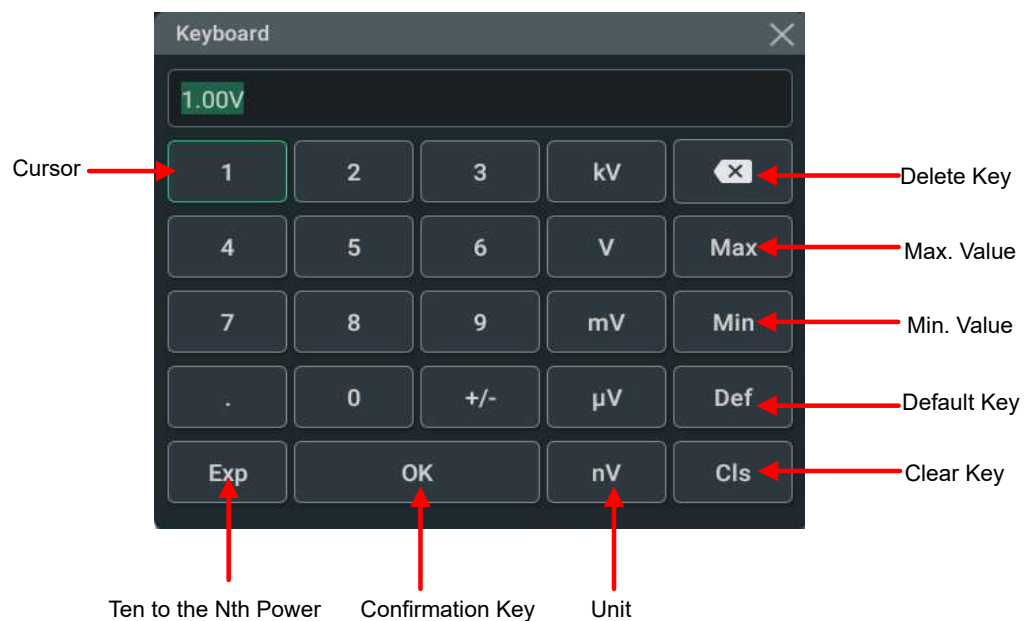
For this instrument, you can use the knob and touch screen operation to set parameters. The common parameter setting methods are as follows:

- **Method 1:** Some parameters can be adjusted by rotating the knob on the front panel.
- **Method 2:** Click or tap the input field of a specified parameter, then a virtual input keypad is displayed. Complete the parameter setting with the keypad.

### Input a Value

When setting or modifying a parameter, input an appropriate value with the keypad.

- Click or tap the value or unit in the virtual keypad to complete the input.
- Rotate the multifunction knob (1/2) to move the cursor to select the desired value and unit. Press down the knob to confirm the input.



**Figure 8.1 Numeric Keypad**

After you input all the values and select the desired units, the numeric keypad is turned off automatically. This indicates that you have completed parameter setting. Besides, after you have input the values, you can also click or tap "OK" directly to close the numeric keypad. At this time, the unit of the parameter is the default unit. In the numeric keypad, you can perform the following operation:

- Deletes the parameter value that has been input;
- Sets the parameter value to a maximum or minimum value;

- Sets the parameter to a default value;
- Clears the parameter value.

## 9 To Replace the Fuse

If you need to replace the fuse, please use the proper fuse (AC 250 V, T5 A; 5.2 mm×20 mm) and follow the steps shown below.

1. Power off the instrument and remove the power cord.
2. Insert a small straight screwdriver into the slot at the power socket and pry out the fuse holder gently.
3. Remove the fuse.
4. Insert the proper fuse into the fuse holder.
5. Re-insert the fuse holder into the power socket.

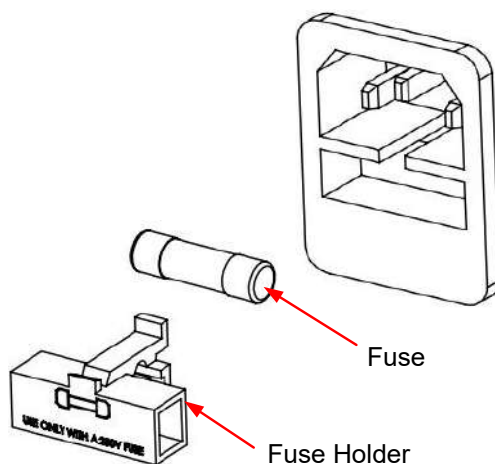


Figure 9.1 Replace the Fuse



### WARNING

To avoid electric shock, please make sure that the instrument is powered off and disconnected from the power before replacing the fuse. Also, please make sure the fuse is consistent with the required fuse rating.

## 10 Remote Control

---

The following ways of remote control are supported:

- **User-defined Programming**

Users can program and control the instrument by using the SCPI (Standard Commands for Programmable Instruments) commands. For details about the SCPI commands and programming, refer to Programming Guide of this product series.

- **Web Control**

The instrument supports the Web Control function. Web Control is a browser-based remote control technology that allows the user to remotely access and control the instrument over the network without additional software installation. By using the web browser to remotely access the networked instrument, the control terminals (e.g. PC, Mobile, iPad, and other smart terminals) display the instrument interface in real time. Users can view device information, adjust the oscilloscope's timebase and vertical sensitivity, configure trigger conditions, and more. Operation Procedures are as follows:

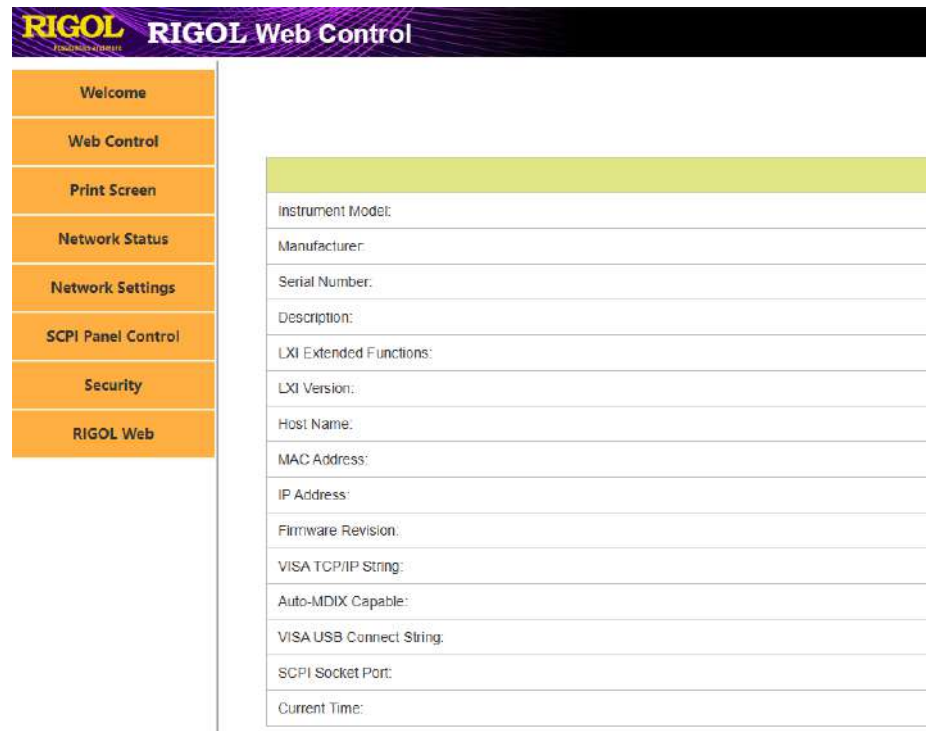
1. Connect the instrument to the network

First ensure that the rear-panel LAN interface is connected to the network. Note that the instrument must be connected to and accessed through the network that located in the same network domain as the control terminal.

2. Obtain the instrument IP address

Click or tap the function navigation icon  at the lower-left of the screen. Click or tap **Utility**, and view the instrument IP address under the IO menu.

3. Type the instrument IP address into the browser address bar and press Enter, and the following interface will be displayed.



4. Click **Web Control** on the left side of the screen to enter the instrument remote control interface. You can use the mouse to remotely control the instrument in real time, with the same effect as operating the instrument directly.
5. Click **Print Screen**, and you can select "Take Screenshot" or "Record Screen" to capture the current display content.
6. Click **Network Settings** to configure the network. Note that login is required when changing the network configuration. The default username and password for first-time Web Control login are "admin" and "rigol".
7. The SCPI Panel Control function allows the user to send SCPI commands through the web interface for remote programming control of the instrument. Click **SCPI Panel Control** and enter the commands in the SCPI Command input field. After entering the commands, click the **Send&Read** button to control the instrument remotely. For details about the SCPI commands and programming, refer to Programming Guide of this product series.
8. Close the browser to exit the instrument remote control interface.

The instrument IP address allows only one user to log in for remote login control. Concurrent logins are not allowed. If the connection is interrupted, you can refresh the browser to load the page.




**CAUTION**

**Before connecting the communication cable, please turn off the instrument to avoid causing damage to the communication interfaces.**

# 11 More Product Information

---

## 1. Obtain the Device Information

Click or tap  > **Utility** > **About** to obtain the information of the instrument, such as the model, serial number, and hardware version number.

## 2. View the Option Information and Install the Option

The instrument is installed with the trial versions of the options before leaving factory. The trial time starts from the time when you power on the instrument for the first time, and the trial time is about 2,160 minutes. Open the "Utility" menu, and then click or tap **Option List** to view the options currently installed on the oscilloscope and their information. For details about the option installation, refer to descriptions in User Guide.

For more information about this instrument, refer to the relevant manuals by logging in to the official website of RIGOL (<http://www.rigol.com>) to download them.

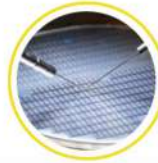
- *MSO/DS9000 Series User Guide* introduces the functions of the instrument and the operation methods, remote control methods, possible failures and solutions in using the instrument, the technical specifications, and order information.
- *MSO/DS9000 Series Programming Guide* provides detailed descriptions of SCPI commands and programming examples of the instrument.
- *MSO/DS9000 Series Data Sheet* provides the main features and technical specifications of the instrument.

# Boost Smart World and Technology Innovation

Industrial Intelligent  
Manufacturing



Semiconductors



Education &  
Research



Communication

System Integration



New Energy



- 5G Cellular-5G/WIFI
- UWB/RFID/ ZIGBEE
- Digital Bus/Ethernet
- Optical Communication

- Digital/Analog/RF Chip
- Memory and MCU Chip
- Third-Generation Semiconductor
- Solar Photovoltaic Cells

- New Energy Automobile
- PV/Inverter
- Power Test
- Automotive Electronics

Provide Testing and Measuring Products  
and Solutions for Industry Customers

## HEADQUARTER

**RIGOL TECHNOLOGIES CO., LTD.**  
No.8 Keling Road, New District,  
Suzhou, JiangSu, P.R.China  
Tel: +86-400620002  
Email: info-cn@rigol.com

## JAPAN

**RIGOL JAPAN CO., LTD.**  
5F, 3-45-6, Minamiotsuka, Toshima-Ku,  
Tokyo, 170-0005, Japan  
Tel: +81-3-6262-8932  
Fax: +81-3-6262-8933  
Email: info.jp@rigol.com

## EUROPE

**RIGOL TECHNOLOGIES EU GmbH**  
Friedrichshafener Str. 5  
82205 Gilching  
Germany  
Tel: +49(0)8105-27292-21  
Email: info-europe@rigol.com

## KOREA

**RIGOL KOREA CO., LTD.**  
5F, 222, Gonghang-daero,  
Gangseo-gu, Seoul, Republic of Korea  
Tel: +82-2-6953-4466  
Fax: +82-2-6953-4422  
Email: info.kr@rigol.com

## NORTH AMERICA

**RIGOL TECHNOLOGIES, USA INC.**  
10220 SW Nimbus Ave.  
Suite K-7  
Portland, OR 97223  
Tel: +1-877-4-RIGOL-1  
Email: sales@rigol.com

## For Assistance in Other Countries

Email: info.int@rigol.com