

30MHz – 3000 MHz Biconical Measurement Antenna

1 Introduction

The TBMA1B is a small, lightweight, wideband biconical measurement antenna. With its moderate price, it is targeting radiated noise EMC pre-compliance testing and generating defined field strengths. It is characterized from 30 MHz to 3 GHz and has a directional pattern similar to a dipole.



2 Product overview

The TBMA1B comes in an aluminum carrying case, together with a “pistol-grip” tripod. A standard ¼” thread makes it easy to connect it to most standard tripods.

The elements are corrosion resistant and constructively locked against rotation. They are fed via a wideband balun with 2 W power handling capability. Furthermore they are protected against build-up of static charge.



30MHz – 3000 MHz Biconical Measurement Antenna

3 Technical specifications

Type	Passive biconical
Frequency range	30 MHz– 3000 MHz
VSWR	<4.65 (f > 200 MHz)
Isotropic gain at 3m spacing	-38.46 ... 1 dBi
Antenna factor at 3m spacing	17.24 ... 51.20 dB/m
Maximum continuous input RF power	2W
Nominal impedance	50 Ω
RF Connector	N type female
Matching	1:2 transformer + 1:1 balun
Tripod Adapter Thread Size	1/4 "
Mechanical Dimensions	L x W x H: 430.73 mm x 163.08 mm x 138.79 mm (16.96" x 6.42" x 5.46")
Weight	0.46 kg (1.01 lbs)

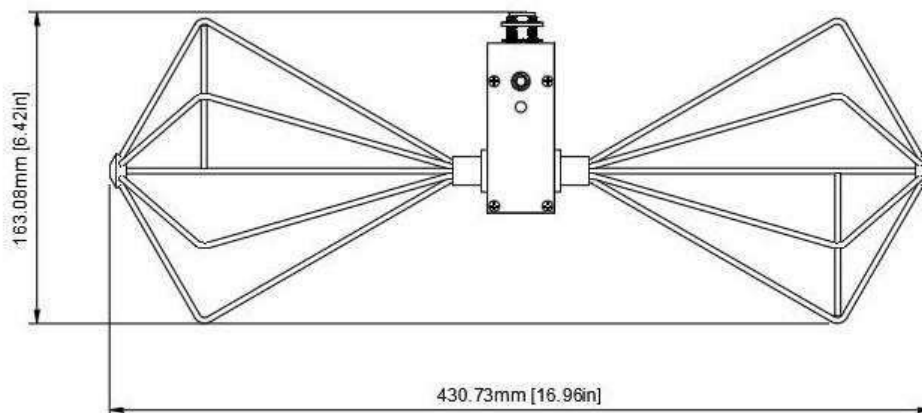
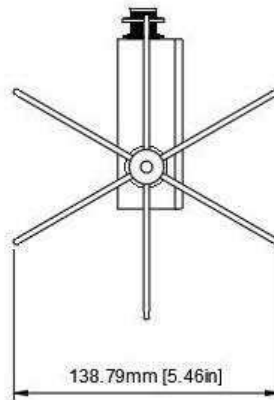

30MHz – 3000 MHz Biconical Measurement Antenna

4 TBMA1B Antenna characterization

The TBMA1B has been characterized using standard calibration techniques and the results are documented in the tables further down.

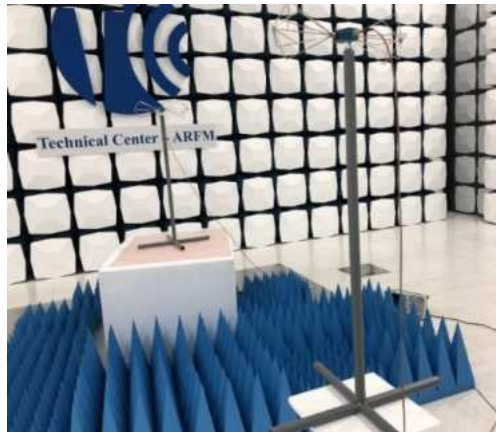

TBMA1B characterization set up inside a 10m Semi Anechoic Chamber (SAC)

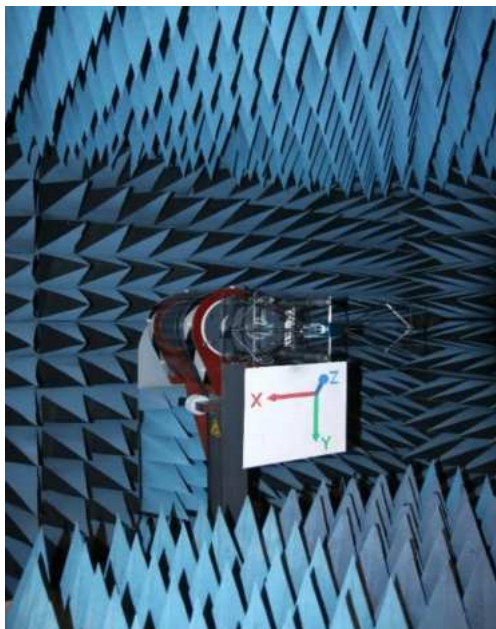

TBMA1B characterization setup inside an antenna test house

30MHz – 3000 MHz Biconical Measurement Antenna

4.1 Gain & Antenna Factor versus frequency

Frequency	Gain Isotropic (10m_Antenna Center)	Antenna Factor (10m_Antenna Center)	Gain Isotropic (3m_Antenna Center)	Antenna Factor (3m_Antenna Center)	Gain Isotropic (1m_Antenna Center)	Antenna Factor (1m_Antenna Center)
MHz	dBi	dB/m	dBi	dB/m	dBi	dB/m
30	-37.12	36.88	-38.46	38.22	-39.35	39.11
35	-35.67	36.77	-35.93	37.03	-37.08	38.18
40	-33.01	35.27	-33.45	35.71	-34.66	36.92
45	-30.47	33.76	-31.17	34.46	-32.36	35.64
50	-28.21	32.41	-28.74	32.94	-30.31	34.51
55	-26.35	31.37	-26.44	31.47	-28.52	33.55
60	-24.55	30.34	-24.81	30.59	-27.11	32.89
65	-23.12	29.60	-23.85	30.33	-25.59	32.07
70	-21.77	28.89	-22.32	29.44	-23.80	30.92
75	-20.75	28.47	-20.74	28.46	-22.71	30.43
80	-19.70	27.98	-19.73	28.01	-21.26	29.54
85	-18.70	27.51	-19.10	27.91	-20.15	28.96
90	-17.32	26.62	-18.03	27.33	-19.43	28.74
95	-16.10	25.88	-16.35	26.13	-17.70	27.47
100	-15.05	25.27	-14.97	25.19	-16.47	26.69
105	-14.05	24.69	-14.16	24.81	-15.20	25.84
110	-13.37	24.41	-13.46	24.51	-13.88	24.92
115	-12.34	23.77	-12.38	23.81	-13.28	24.71
120	-11.52	23.32	-11.16	22.96	-12.78	24.58
125	-10.58	22.74	-10.21	22.36	-11.78	23.94
130	-9.89	22.38	-9.75	22.25	-11.12	23.62
135	-9.01	21.83	-9.33	22.15	-10.15	22.97
140	-8.40	21.54	-8.38	21.52	-9.15	22.29
145	-7.47	20.92	-7.41	20.85	-8.30	21.75
150	-6.91	20.65	-6.66	20.40	-7.44	21.18
155	-5.96	19.98	-5.84	19.86	-6.73	20.76
160	-5.27	19.57	-5.07	19.37	-6.11	20.42
165	-4.34	18.91	-4.52	19.09	-5.56	20.13
170	-3.88	18.70	-4.08	18.91	-4.95	19.78
175	-3.18	18.26	-3.43	18.51	-4.01	19.09
180	-2.69	18.02	-2.74	18.07	-3.44	18.77
185	-2.11	17.67	-2.36	17.92	-2.99	18.55
190	-1.74	17.54	-2.12	17.91	-2.69	18.49
200	-1.39	17.63	-1.28	17.52	-1.92	18.16
210	-1.10	17.76	-0.73	17.40	-1.51	18.18
220	-0.59	17.66	-0.20	17.26	-0.75	17.82
230	-0.13	17.59	-0.23	17.68	-0.32	17.78
240	0.43	17.40	-0.18	18.00	-0.34	18.16
250	0.74	17.44	0.12	18.06	-0.02	18.20
260	0.43	18.09	0.12	18.40	0.15	18.37
270	0.28	18.57	0.40	18.44	-0.13	18.98
280	0.37	18.79	0.44	18.72	-0.15	19.32
290	0.41	19.06	0.45	19.01	-0.16	19.63
300	0.50	19.27	0.70	19.07	-0.04	19.80
325	0.33	20.13	0.40	20.06	0.36	20.09
350	0.16	20.94	0.26	20.84	0.31	20.79
375	0.31	21.40	0.52	21.18	0.09	21.61
400	0.45	21.81	0.62	21.64	0.30	21.96

30MHz – 3000 MHz Biconical Measurement Antenna

425	0.71	22.07	0.23	22.56	-0.01	22.80
450	0.98	22.31	0.39	22.89	0.53	22.75
475	0.85	22.91	0.67	23.08	0.46	23.29
500	0.71	23.49	0.30	23.89	0.04	24.16
550	0.81	24.21	0.23	24.80	0.22	24.81
600	0.23	25.55	0.29	25.50	-0.16	25.95
650	-0.08	26.56	0.04	26.44	-0.07	26.55
700	0.22	26.90	0.09	27.03	-0.33	27.45
750	-0.06	27.78	-0.85	28.57	-0.73	28.45
800	0.12	28.17	-0.28	28.56	-0.80	29.08
850	-0.98	29.79	-1.09	29.90	-1.33	30.14
900	-0.71	30.02	-0.83	30.13	-2.43	31.74
950	-0.90	30.67	-2.19	31.96	-2.59	32.36
1000	-3.45	33.67	-3.47	33.69	-4.98	35.20
1050	-3.35	34.00	-4.32	34.96	-4.50	35.14
1100	-6.18	37.23	-6.04	37.09	-7.14	38.19
1150	-9.32	40.76	-7.87	39.31	-8.35	39.78
1200	-8.70	40.50	-8.96	40.76	-9.87	41.67
1300	-14.42	46.92	-13.69	46.18	-11.98	44.48
1400	-9.89	43.03	-12.86	46.00	-11.10	44.24
1500	-10.48	44.22	-9.36	43.10	-9.21	42.95
1600	-7.76	42.06	-8.31	42.61	-8.12	42.42
1700	-6.60	41.42	-7.32	42.15	-7.73	42.56
1800	-6.21	41.53	-6.49	41.81	-7.51	42.83
1900	-5.30	41.10	-4.66	40.45	-6.04	41.83
2000	-4.68	40.92	-5.77	42.01	-6.86	43.10
2100	-7.98	44.65	-7.72	44.38	-8.16	44.82
2200	-10.49	47.56	-8.61	45.68	-7.10	44.16
2300	-8.41	45.87	-7.69	45.15	-6.57	44.02
2400	-8.13	45.95	-7.82	45.65	-6.38	44.21
2500	-10.13	48.31	-9.52	47.70	-6.58	44.76
2600	-10.26	48.78	-10.19	48.71	-7.33	45.85
2700	-10.79	49.64	-10.28	49.13	-8.03	46.87
2800	-9.54	48.70	-9.90	49.06	-9.09	48.26
2900	-9.81	49.28	-9.51	48.98	-9.59	49.06
3000	-10.70	50.46	-11.44	51.20	-11.74	51.50

30MHz – 3000 MHz Biconical Measurement Antenna

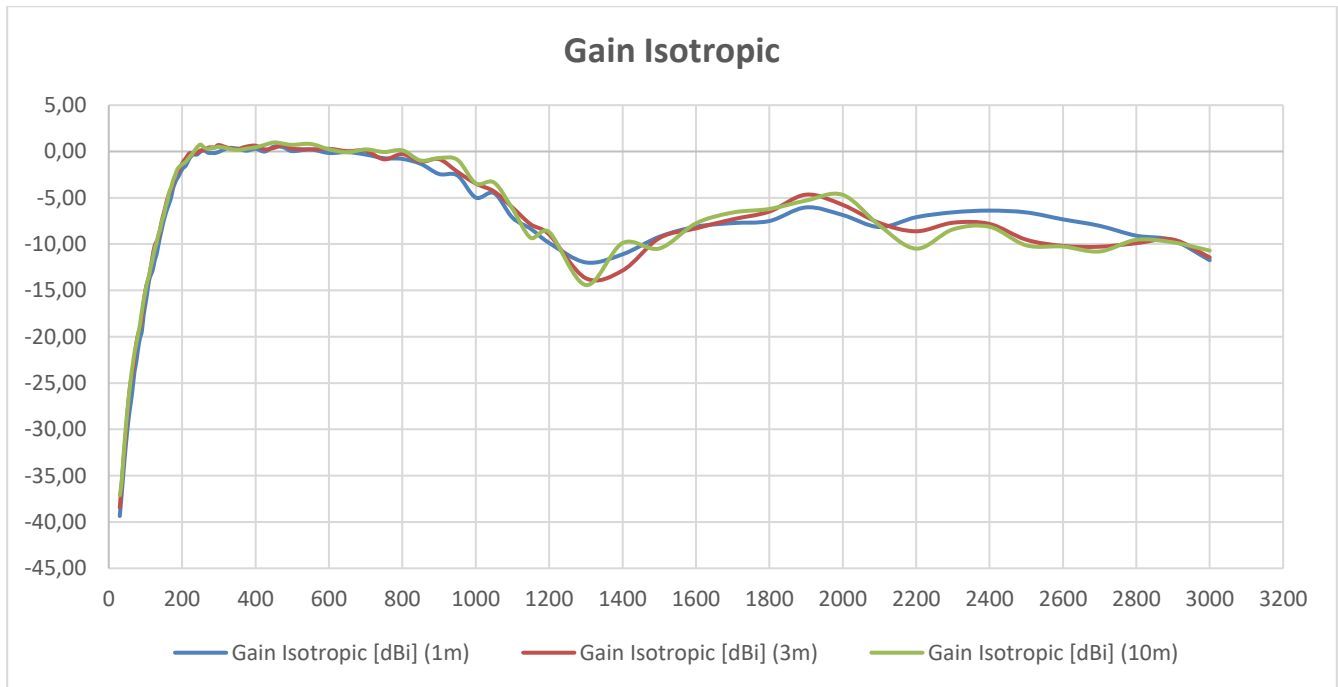

30 MHz ... 3000 MHz, Isotropic Gain of TBMA1B

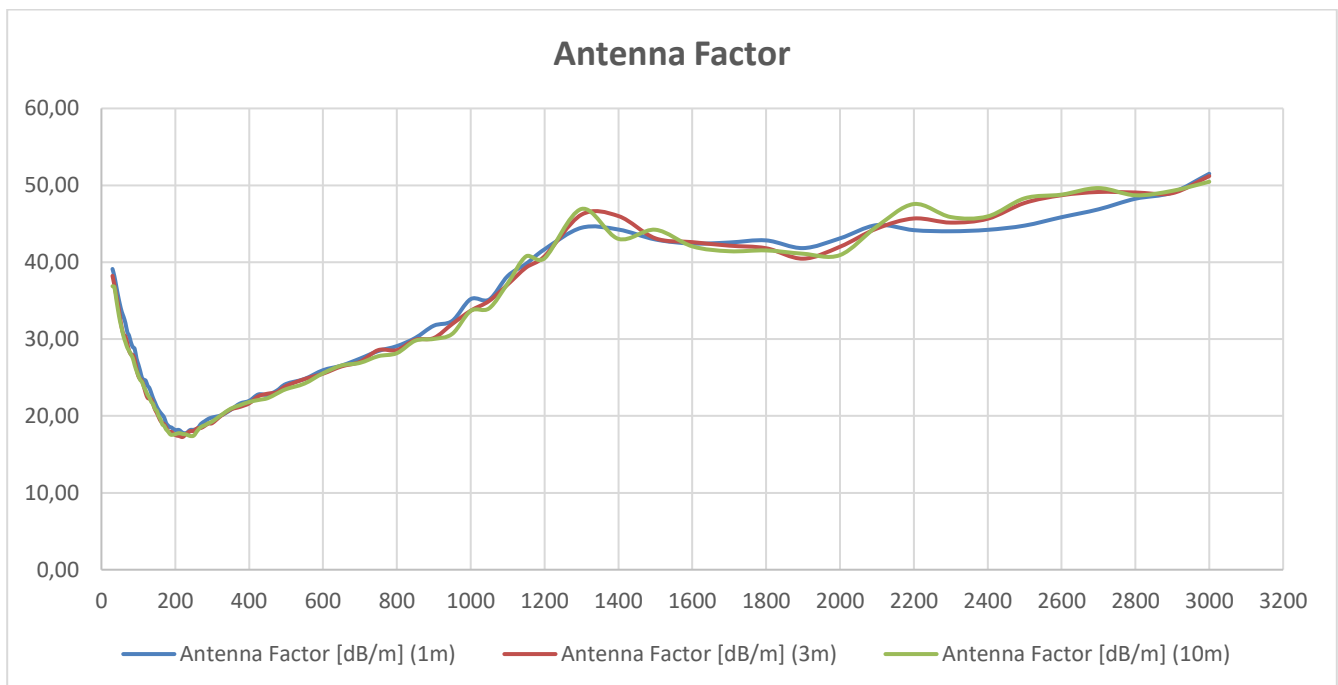

30MHz – 3000 MHz Biconical Measurement Antenna

30 MHz ... 3000 MHz, Antenna Factor of TBMA1B

4.2 TBMA1B Return Loss / VSWR

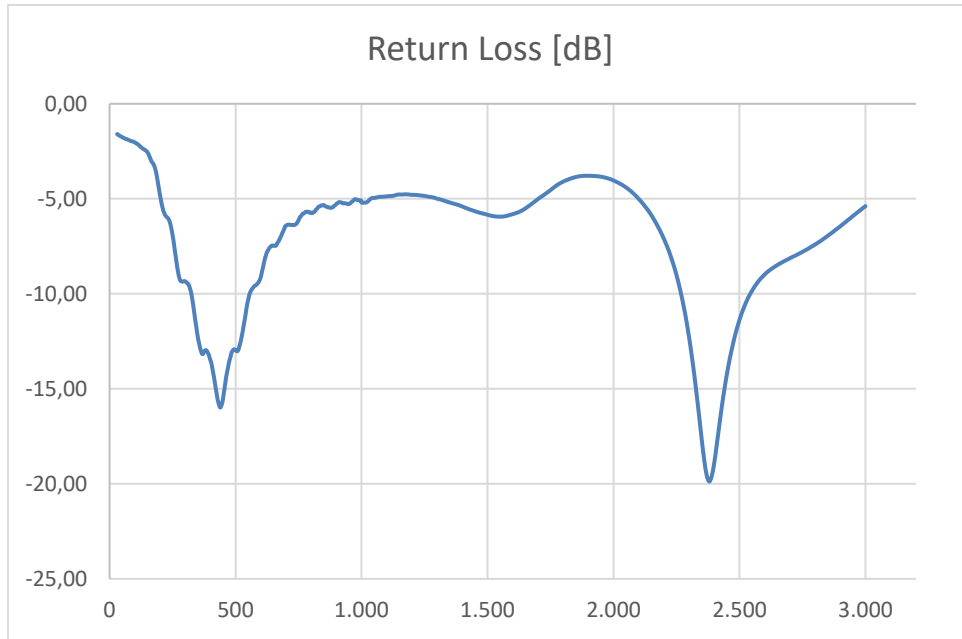

TBMA1B, S11, 30 MHz ... 3000 MHz

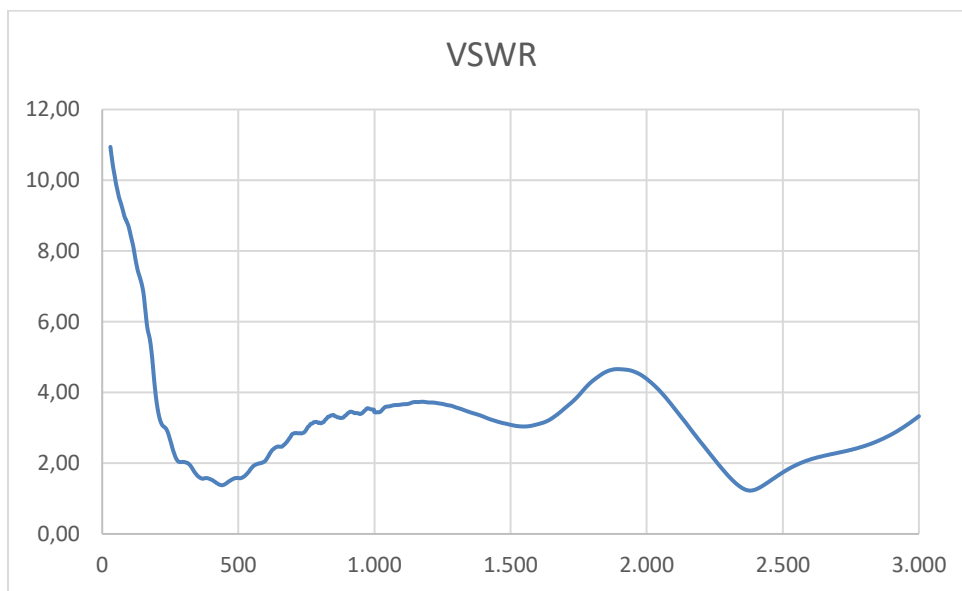

TBMA1B, VSWR, 30 MHz ... 3000 MHz

30MHz – 3000 MHz Biconical Measurement Antenna

Detailed test reports from Seibersdorf Laboratories can be downloaded from our website.

Symmetry: At frequencies below 60 MHz, the TBMA1B becomes slightly asymmetric. This is not relevant in horizontal orientation. When using the antenna in vertical orientation, position the antenna so that the engraved text on the housing is oriented reversed / upside down.

5 Application

The TBMA1B was designed, targeting radiated noise EMC pre-compliance measurements. To make optimum use of the TBMA1B, a few details need to be considered:

The TBMA1B does not contain any filters at the output port. Consequently, high amplitude signals that appear at the RF output, especially when employing external pre-amplifiers might overdrive the spectrum analyzer and the resulting intermodulation will cause measurement errors. In environments with high ambient noise levels, using suitable filters may be of advantage.

The ambient noise level picked up by the antenna in an unshielded environment, combined with the base noise level of the analyzer may already cross the radiated emission limits of certain CISPR standards, even with no DUT present. Consequently, it may be very difficult to differentiate ambient noise and radiated noise from the DUT in an unshielded environment.

Even turning ON/OFF the DUT to identify the radiated noise from the DUT may often not be a solution, given the dynamic characteristics of contemporary sources of ambient noise.

A suitable procedure is first measuring the radiated noise of the DUT in a TEM cell which is placed in a shielded tent or shielded bag. This will give an excellent overview of the emitted noise spectrum of the DUT. You can easily identify the strongest emissions of the DUT and thereafter re-measure it in an open area test site (OATS) with the measurement antenna. You then don't need to confuse yourself with the entire ambient spectrum. Simply set the center frequency of the analyzer to the critical emission frequencies of the DUT, one by one. Choose a span as narrow as possible to zoom only at the frequency of the investigated DUT spurious. In case that the base noise is still too high, you can use suitable external bandpass filters, reduce the resolution bandwidth of the analyzer or move the antenna closer to the DUT until you can clearly identify the DUT spurious and measure its level. As long as you keep your antenna in the far field, you can easily convert from the actual measurement distance to the equivalent level in 3m or 10m distance.

In case that the DUT spurious exceed the limit of the standard, take it back to your lab and use near field probes to locate the origin of the spurious on your DUT PCBA. Take suitable measures to reduce the emissions of your product. Track the effect of the modifications by TEM cell measurements, until the relative improvement measured in the TEM cell matches the relative improvement required to meet the far field limits according to the relevant standard.

Then carry out another OATS measurement of the DUT to validate, if the DUT's radiated emissions are within the limits when measured with an antenna.

Use following formula to convert the measurement result from the actual measurement distance to the distance specified in the relevant standard:

$$P_s = P_m + 20 \log \frac{D_m}{D_s} \text{ [dBm]}$$

where D_m is the actual measurement distance and D_s is the specified distance in the relevant standard.

P_m is the RF power measured in the actual measurement distance.

P_s represents the calculated equivalent RF power in the distance specified in the relevant standard.

30MHz – 3000 MHz Biconical Measurement Antenna

Alternatively use the conversion table below:

Conversion 1 m to 3 m	subtract 9.5 dB
Conversion 1 m to 10 m	subtract 20 dB
Conversion 2 m to 3 m	subtract 3.5 dB
Conversion 2 m to 10 m	subtract 14 dB
Conversion 3 m to 10 m	subtract 10.5 dB

However, when applying the conversions above, be aware, that even in the set up specified in the standards, the measurement antenna is not in the far field across the entire frequency range. This would physically be impossible, given the size limitations of anechoic chambers.

6 Ordering Information

Part Number	Description
TBMA1B	30 MHz – 3 GHz biconical measurement antenna, mini tripod, aluminum carrying case

7 History

Version	Date	Author	Changes
V1.0	20.3.2025	Mayerhofer	Creation of the document