



**RIGOL**

# DG6000 Series

Function/Arbitrary Waveform Generator

**Quick Guide**

Dec. 2025

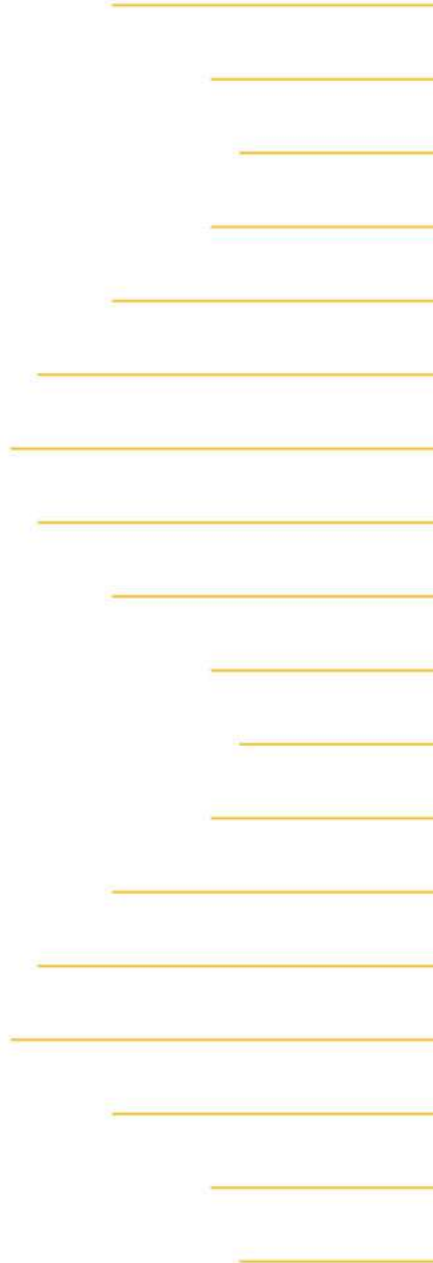

## **Guaranty and Declaration**

### **Copyright**

© 2025 RIGOL TECHNOLOGIES CO., LTD. All Rights Reserved.

### **Trademark Information**

RIGOL® is the trademark of RIGOL TECHNOLOGIES CO., LTD.

### **Software Version**

Software upgrade might change or add product features. Please acquire the latest software version from **RIGOL** website or contact **RIGOL** to upgrade the software.

### **Notices**

- RIGOL products are covered by P.R.C. and foreign patents, issued and pending.
- RIGOL reserves the right to modify or change parts of or all the specifications and pricing policies at the company's sole decision.
- Information in this publication replaces all previously released materials.
- Information in this publication is subject to change without notice.
- RIGOL shall not be liable for either incidental or consequential losses in connection with the furnishing, use, or performance of this manual, as well as any information contained.
- Any part of this document is forbidden to be copied, photocopied, or rearranged without prior written approval of RIGOL.

### **Product Certification**

RIGOL guarantees that this product conforms to the national and industrial standards in China as well as the ISO9001:2015 standard and the ISO14001:2015 standard. Other international standard conformance certifications are in progress.

### **Contact Us**

If you have any problem or requirement when using our products or this manual, please contact RIGOL.

E-mail: [service@rigol.com](mailto:service@rigol.com)

Website: <http://www.rigol.com>

| Section | Description   | Page |
|---------|---|------|
| 1       | Safety Requirement .....                                    | 1    |
| 1.1     | General Safety Summary .....                                | 1    |
| 1.2     | Safety Notices and Symbols .....                            | 1    |
| 1.3     | Measurement Category .....                                  | 2    |
| 1.4     | Ventilation Requirement .....                               | 3    |
| 1.5     | Working Environment .....                                   | 3    |
| 1.6     | Care and Cleaning .....                                     | 4    |
| 1.7     | Environmental Considerations .....                          | 5    |
| 2       | Document Overview .....                                     | 6    |
| 3       | General Inspection .....                                    | 7    |
| 4       | Product Overview .....                                      | 8    |
| 4.1     | Appearance .....  | 8    |
| 4.2     | Dimensions .....  | 9    |
| 4.3     | Front Panel Overview .....                                  | 10   |
| 4.4     | Rear Panel Overview .....                                   | 12   |
| 4.5     | Output Type .....   | 12   |
| 4.6     | 2-Channel Model User Interface Overview .....               | 13   |
| 4.7     | 4-Channel Model User Interface Overview .....               | 14   |
| 5       | To Prepare for Use .....                                    | 19   |
| 5.1     | To Adjust the Supporting Legs .....                         | 19   |
| 5.2     | To Connect to Power .....                                   | 19   |
| 5.3     | Turn-on Checkout .....                                      | 20   |
| 5.4     | To Set the System Language .....                            | 20   |
| 6       | To Use the Built-in Help System .....                       | 22   |
| 7       | To Use the Security Lock .....                              | 23   |
| 8       | Parameter Setting Method .....                              | 24   |
| 8.1     | To Set Parameters with the Front-panel Keys and Knobs ..... | 24   |
| 8.2     | To Set Parameters with the Touch Screen .....               | 26   |
| 9       | To Replace the Fuse .....                                   | 28   |
| 10      | Remote Control .....  | 29   |
| 11      | Troubleshooting .....                                       | 30   |
| 12      | More Product Information .....                              | 32   |



# 1 Safety Requirement

## 1.1 General Safety Summary

Please review the following safety precautions carefully before putting the instrument into operation so as to avoid any personal injury or damage to the instrument and any product connected to it. To prevent potential hazards, please follow the instructions specified in this manual to use the instrument properly.

- |   |  |    |   |
|---|--|----|---|
| 1 | Only the exclusive power cord designed for the instrument and authorized for use within the destination country could be used. | 9  | Do not operate the instrument with suspected failures.                                    |
| 2 | Ensure that the instrument is safely grounded.   | 10 | Provide adequate ventilation.   |
| 3 | Observe all terminal ratings.  | 11 | Do not operate in wet conditions.   |
| 4 | Use proper overvoltage protection.   | 12 | Do not operate in an explosive atmosphere.  |
| 5 | Do not operate without covers.   | 13 | Keep instrument surfaces clean and dry.   |
| 6 | Do not insert objects into the air outlet.   | 14 | Prevent electrostatic impact.   |
| 7 | Use the proper fuse.   | 15 | Handle with caution.  |
| 8 | Avoid circuit or wire exposure.  | 16 | Please use the front-panel BNC output connectors properly. They only allow signal output. |



### WARNING

Equipment meeting Class A requirements may not offer adequate protection to broadcast services within residential environment.

## 1.2 Safety Notices and Symbols

Safety Notices in this Manual:



### WARNING

Indicates a potentially hazardous situation or practice which, if not avoided, will result in serious injury or death.



### CAUTION

Indicates a potentially hazardous situation or practice which, if not avoided, could result in damage to the product or loss of important data.

**Safety Notices on the Product:**

- **DANGER**  
It calls attention to an operation, if not correctly performed, could result in injury or hazard immediately.
- **WARNING**  
It calls attention to an operation, if not correctly performed, could result in potential injury or hazard.
- **CAUTION**  
It calls attention to an operation, if not correctly performed, could result in damage to the product or other devices connected to the product.

**Safety Symbols on the Product:**

**Hazardous Voltage**



**Safety Warning**



**Protective Earth Terminal**



**Chassis Ground**



**Test Ground**

## 1.3 Measurement Category

**Measurement Category**

This instrument can make measurements in Measurement Category I.

**WARNING**

**This instrument can only be used for measurements within its specified measurement categories.**

**Measurement Category Definitions**

- **Measurement category I** is for measurements performed on circuits not directly connected to MAINS. Examples are measurements on circuits not derived from MAINS, and specially protected (internal) MAINS derived circuits. In the latter case, transient stresses are variable. Thus, you must know the transient withstand capability of the equipment.
- **Measurement category II** is for measurements performed on circuits directly connected to low voltage installation. Examples are measurements on household appliances, portable tools and similar equipment.
- **Measurement category III** is for measurements performed in the building installation. Examples are measurements on distribution boards, circuit-breakers, wiring (including cables, bus-bars, junction boxes, switches and socket-outlets) in the fixed installation, and equipment for industrial use and some other

equipment. For example, stationary motors with permanent connection to a fixed installation.

- **Measurement category IV** is for measurements performed at the source of a low-voltage installation. Examples are electricity meters and measurements on primary overcurrent protection devices and ripple control units.

## 1.4 Ventilation Requirement

This instrument uses a fan to force cooling. Please make sure that the air inlet and outlet areas are free from obstructions and have free air. When using the instrument in a bench-top or rack setting, provide at least 10 cm clearance beside, above and behind the instrument for adequate ventilation.



### CAUTION

Inadequate ventilation may cause an increase of temperature in the instrument, which would cause damage to the instrument. So please keep the instrument well ventilated and inspect the air outlet and the fan regularly.

## 1.5 Working Environment

### Temperature

Operating: 0°C to +40°C

Non-operating: -20°C to +60°C

### Humidity

- **Operating:**  
0°C to +40°C: ≤80% RH (without condensation)
- **Non-operating:**  
-20°C to +40°C: ≤90% RH (without condensation)  
Below +60°C: ≤80% RH (without condensation)



### WARNING

To avoid short circuit inside the instrument or electric shock, never operate the instrument in a humid environment.

### Altitude

- **Operating:** below 3 km
- **Non-operating:** below 12 km

### Protection Level Against Electric Shock

ESD  $\pm 8\text{kV}$

### Installation (Overvoltage) Category

This product is powered by mains conforming to installation (overvoltage) category II.



#### WARNING

Ensure that no overvoltage (such as that caused by a bolt of lightning) can reach the product. Otherwise, the operator might be exposed to the danger of an electric shock.

### Installation (Overvoltage) Category Definitions

Installation (overvoltage) category I refers to signal level which is applicable to equipment measurement terminals connected to the source circuit. Among these terminals, precautions are done to limit the transient voltage to a low level.

Installation (overvoltage) category II refers to the local power distribution level which is applicable to equipment connected to the AC line (AC power).

### Pollution Degree

Pollution Degree 2

#### Pollution Degree Definition

- **Pollution Degree 1:** No pollution or only dry, nonconductive pollution occurs. The pollution has no effect. For example, a clean room or air-conditioned office environment.
- **Pollution Degree 2:** Normally only nonconductive pollution occurs. Temporary conductivity caused by condensation is to be expected. For example, indoor environment.
- **Pollution Degree 3:** Conductive pollution or dry nonconductive pollution that becomes conductive due to condensation occurs. For example, sheltered outdoor environment.
- **Pollution Degree 4:** The pollution generates persistent conductivity caused by conductive dust, rain, or snow. For example, outdoor areas.

### Safety Class

Class 1 – Grounded Product

## 1.6 Care and Cleaning

### Care

Do not store or leave the instrument where it may be exposed to direct sunlight for long periods of time.

## Cleaning

Clean the instrument regularly according to its operating conditions.

1. Disconnect the instrument from all power sources.
2. Clean the external surfaces of the instrument with a soft cloth dampened with mild detergent or water. Avoid having any water or other objects into the chassis via the heat dissipation hole. When cleaning the LCD, take care to avoid scarifying it.



### CAUTION

To avoid damage to the instrument, do not expose it to caustic liquids.



### WARNING

To avoid short-circuit resulting from moisture or personal injuries, ensure that the instrument is completely dry before connecting it to the power supply.

## 1.7 Environmental Considerations

The following symbol indicates that this product complies with the WEEE Directive 2012/19/EU.



The equipment may contain substances that could be harmful to the environment or human health. To avoid the release of such substances into the environment and avoid harm to human health, we recommend you to recycle this product appropriately to ensure that most materials are reused or recycled properly. Please contact your local authorities for disposal or recycling information.

You can click on the following link <https://www.rigol.com/intl/services/environmental-protection-statement.html> to download the latest version of the RoHS&WEEE certification file.

## 2 Document Overview

This manual gives you a quick overview of the front and rear panels, user interface as well as basic operation methods of the DG6000 series.

### TIP

For the latest version of this manual, download it from RIGOL official website ([www.rigol.com](http://www.rigol.com)).

### Publication Number

QGB19101-1110

### Format Conventions in this Manual

#### 1. Key

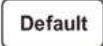
The front panel key is denoted by the menu key icon. For example,  indicates the "Default" key.

#### 2. Menu

The menu item is denoted by the format of "Menu Name (Bold) + Character Shading" in the manual. For example, **Setup**.

#### 3. Operation Procedures

The next step of the operation is denoted by ">" in the manual. For example, .

> **Utility** indicates first clicking or tapping  and then clicking or tapping **Utility**.

### Content Conventions in this Manual

The DG6000 series Function/Arbitrary Waveform Generator includes the following models. Unless otherwise specified, this manual takes DG6104 as an example to illustrate the basic operation methods of the DG6000 series.

| Model  | No. of Channels | Sample Rate | Max. Output Frequency |
|--------|-----------------|-------------|-----------------------|
| DG6052 | 2               | 2.5 GSa/s   | 500 MHz               |
| DG6054 | 4               | 2.5 GSa/s   | 500 MHz               |
| DG6102 | 2               | 2.5 GSa/s   | 1 GHz                 |
| DG6104 | 4               | 2.5 GSa/s   | 1 GHz                 |

## 3 General Inspection

---

### 1. Inspect the packaging

If the packaging has been damaged, do not dispose the damaged packaging or cushioning materials until the shipment has been checked for completeness and has passed both electrical and mechanical tests.

The consigner or carrier shall be liable for the damage to the instrument resulting from shipment. RIGOL would not be responsible for free maintenance/rework or replacement of the instrument.

### 2. Inspect the instrument

In case of any mechanical damage, missing parts, or failure in passing the electrical and mechanical tests, contact your RIGOL sales representative.

### 3. Check the accessories

Please check the accessories according to the packing lists. If the accessories are damaged or incomplete, please contact your RIGOL sales representative.

### Recommended Calibration Interval

RIGOL suggests that the instrument should be calibrated every 12 months.

## 4 Product Overview

With up to 2.5 GSa/s sample rate and 256 Mpts/CH arbitrary waveform length (512 Mpts/CH optional), the DG6000 Series Function/Arbitrary Waveform Generator is an all-in-one generator that integrates Function Generator, Arbitrary Waveform Generator, Noise Generator, Pulse Generator, Harmonics Generator, and Analog/Digital Modulator. It supports signal-ended and differential output types and provides functions including Sequence, IQ, Multi-pulse, Multi-tone, Pattern, and PRBS. It is a multi-functional and cost-effective function/arbitrary waveform generator.

### 4.1 Appearance



Figure 4.1 Front Panel



Figure 4.2 Rear Panel

## 4.2 Dimensions

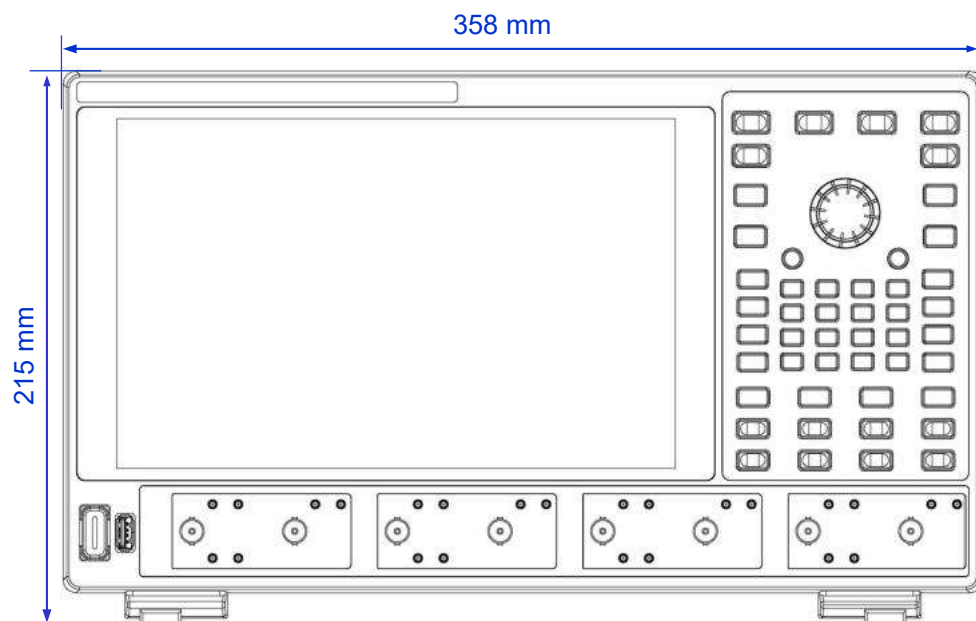

Figure 4.3 Front View

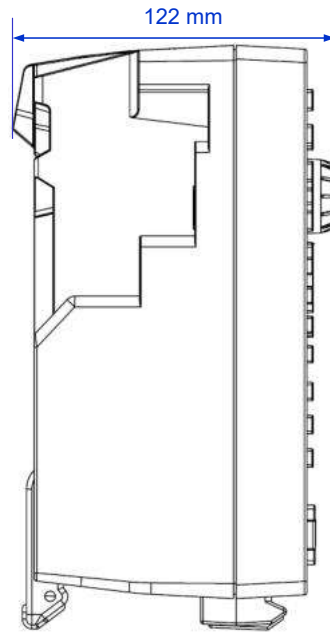

Figure 4.4 Side View

### 4.3 Front Panel Overview

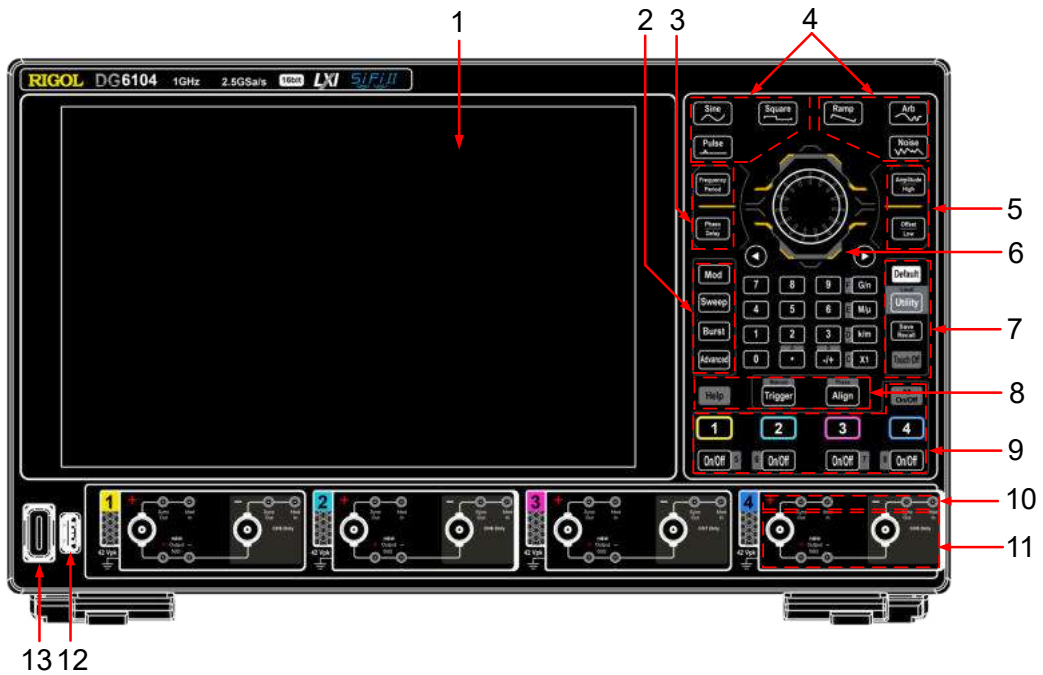

Figure 4.5 Front Panel (4-channel)

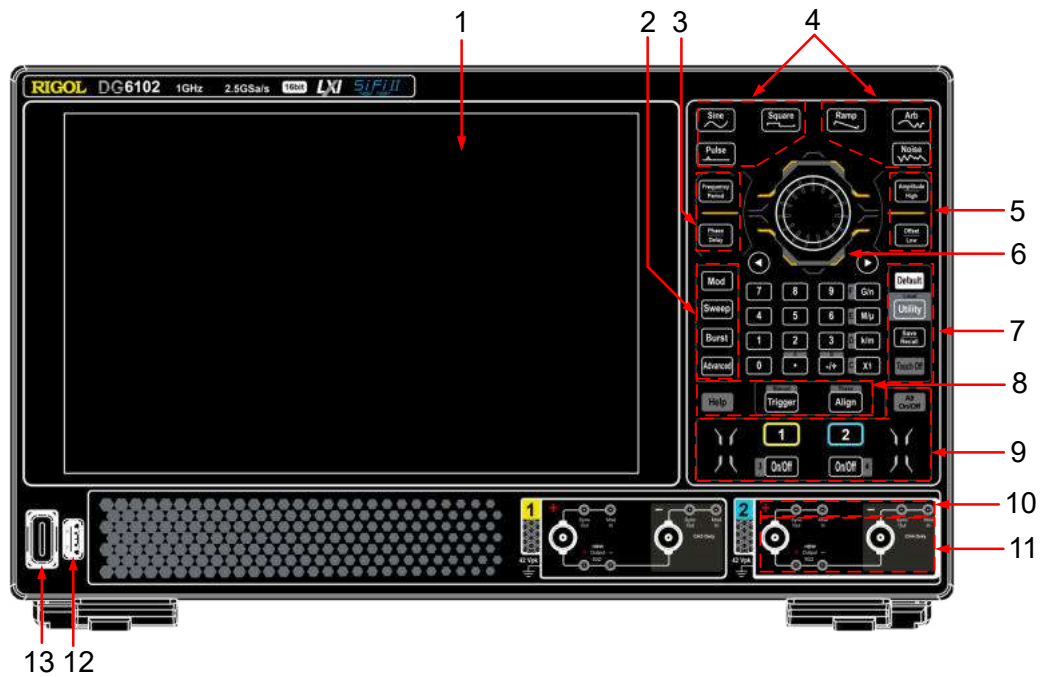

Figure 4.6 Front Panel (2-channel)

|   |   |    |  |
|---|---|----|--|
| 1 | 10.1-inch Touch Screen  | 8  | Help Key, Manual Trigger Key, Align Phase Key  |
| 2 | Output Mode Selection Area                                    | 9  | Channel Output Control Area  |
| 3 | Frequency/Period and Phase/Delay Keys                         | 10 | Sync Output/Trigger Output (Sync Out) Connector, Modulation Input (Mod In) Connector |
| 4 | Basic Waveform Selection Area                                 | 11 | Output Connectors (Single-ended/Differential)  |
| 5 | Amplitude Range/High Level and Offset/Low Level Keys          | 12 | USB HOST Interface   |
| 6 | Parameter Input Area (Knob, Arrow Keys, and Numeric Keyboard) | 13 | Power Key  |
| 7 | Quick Operation Key   |    |  |

## 4.4 Rear Panel Overview

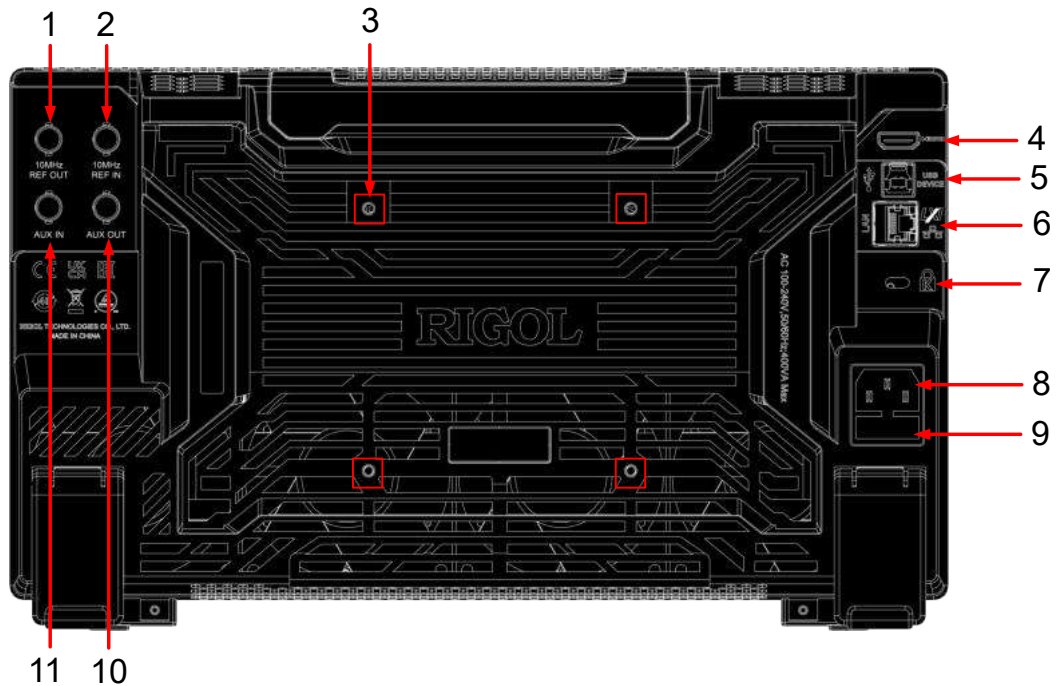

Figure 4.7 Rear Panel

|   |                                       |    |   |
|---|---------------------------------------|----|---|
| 1 | 10 MHz Reference Output Connector     | 7  | Security Lock Hole  |
| 2 | 10 MHz Reference Input Connector      | 8  | AC Power Socket   |
| 3 | Mounting Screw Holes (VESA 100 x 100) | 9  | Fuse  |
| 4 | HDMI Interface                        | 10 | AUX OUT Connector (not used)                                      |
| 5 | USB DEVICE Interface                  | 11 | External Trigger Signal/Digital Modulation Signal Input Connector |
| 6 | LAN Interface                         |    |   |

## 4.5 Output Type

This series Function/Arbitrary Waveform Generator provides three output types: SND,

HBW, and AMP (default). Click or tap  > **Output Type** to open the menu, as shown in the figure below.

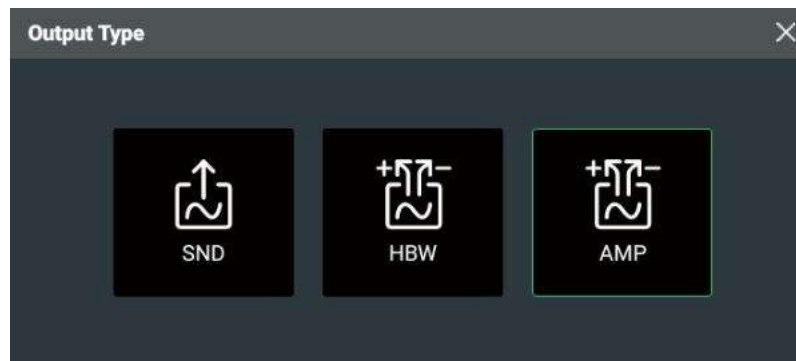

- **SND:** The instrument outputs signals through the front-panel BNC interfaces, and each channel supports two single-ended signal outputs (2-channel models: CH1, CH2, CH3, CH4; 4-channel models: CH1, CH2, CH3, CH4, CH5, CH6, CH7, CH8).
- **HBW:** The instrument outputs high-bandwidth differential signals through a pair of differential output interfaces (SMB) on the front panel.
- **AMP:** The instrument outputs amplitude-amplified differential signals through the front-panel BNC interface.

## 4.6 2-Channel Model User Interface Overview

The 2-channel models of this series support single-channel mode, 2-channel mode, 4-channel mode (single-ended), and auto mode (automatically selecting the display mode based on the number of enabled channels). You can select your desired interface layout based on actual requirements. The user interface in each display mode displays the information for the corresponding number of channels. You can click or tap the **Windows** key at the lower-right of the interface to select different display modes.

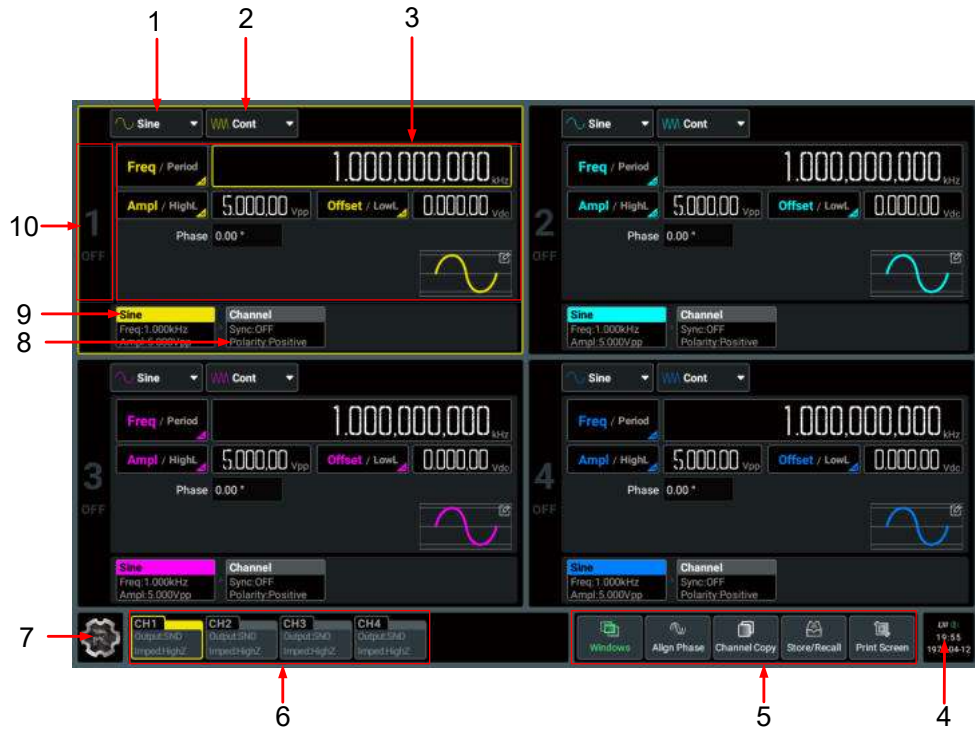

**Figure 4.8 2-Channel Model User Interface - 4-Channel Display Mode (Single-ended)**

- |   |                                 |    |                          |
|---|---------------------------------|----|--------------------------|
| 1 | Basic Waveform Drop-down Button | 6  | Channel Labels           |
| 2 | Output Mode Drop-down Button    | 7  | Function Navigation Icon |
| 3 | Parameter Configuration Area    | 8  | Channel Tab              |
| 4 | Notification Area               | 9  | Waveform Tab             |
| 5 | Function Keys                   | 10 | Channel Identifier       |

## 4.7 4-Channel Model User Interface Overview

The 4-channel models of this series support auto mode, single-channel mode, 2-channel mode, 4-channel mode, and 8-channel mode (single-ended). You can select your desired interface layout based on actual requirements.

### Auto Display Mode

Selects the display mode automatically based on the number of enabled channels.

### Single-Channel Display Mode

In single-channel display mode, the interface displays the waveform parameter setting interface and the channel parameter setting interface of one channel. You can click or tap the channel label at the bottom of the interface to select the channel to display. It allows for easier viewing and quick setup of the target channel.

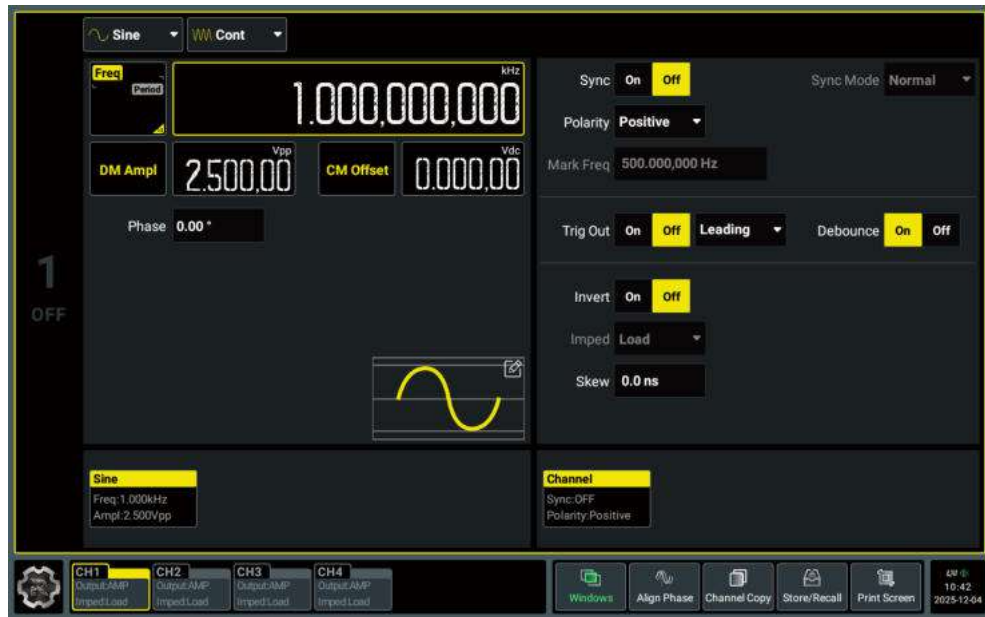

Figure 4.9 4-Channel Model User Interface - Single-Channel Display Mode

## 2-Channel Display Mode

In 2-channel display mode, the interface only displays the information of two channels. You can click or tap the channel label at the bottom of the interface to select the channel to display. The simple and intuitive interface layout is ideal for application scenarios where an individual channel requires attention. It allows for easier viewing and quick setup of the target channel.



Figure 4.10 4-Channel Model User Interface - 2-Channel Display Mode

## 4-Channel Display Mode

In 4-channel display mode, the interface displays the information of four channels at the same time. You can click or tap the channel label at the bottom of the interface to select the channel to display. This mode offers a balanced display layout to meet the requirements of medium-scale multi-channel testing. It enables simultaneous monitoring and quick setup of multiple channels.



Figure 4.11 4-Channel Model User Interface - 4-Channel Display Mode

## 8-Channel Display Mode (Single-ended)

For 4-channel models, 8-channel display mode is supported only in single-ended

output type. You can click or tap  > **Output Type** > **SND** to select single-ended output type. After the 8-channel display mode is selected, the interface displays the main information of eight channels (Figure 4.12). The displayed information is related to the current output waveform. This mode is ideal for use in scenarios requiring comprehensive monitoring of channel output parameters, such as multi-channel collaborative testing in complex systems.

Some parameters are not displayed on the main interface in 8-channel display mode. If you need to view or set the complete parameters related to a channel, you can click

or tap  on the specified channel configuration area to open the parameter setting interface (Figure 4.13). In 8-channel display mode parameter setting interface, click or tap the channel list on the left or the channel label at the bottom to select different channels for viewing and editing. After editing, click or tap **Back** at the bottom-right of the interface to quit the parameter setting interface.

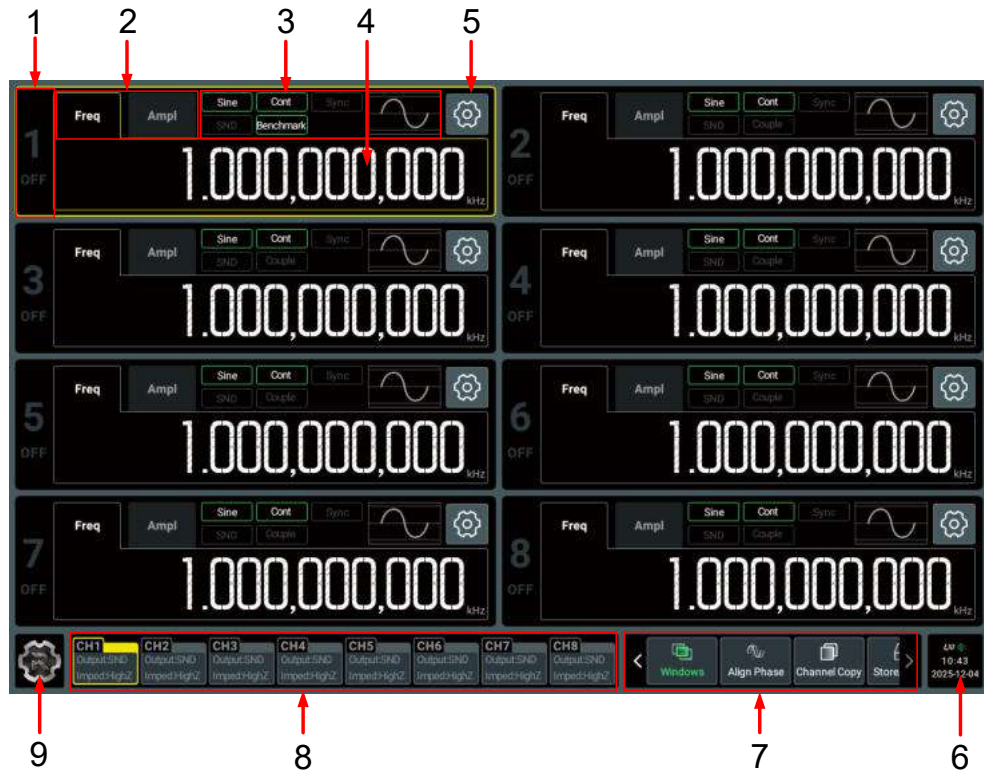

Figure 4.12 4-Channel Model User Interface - 8-Channel Display Mode (Single-ended)

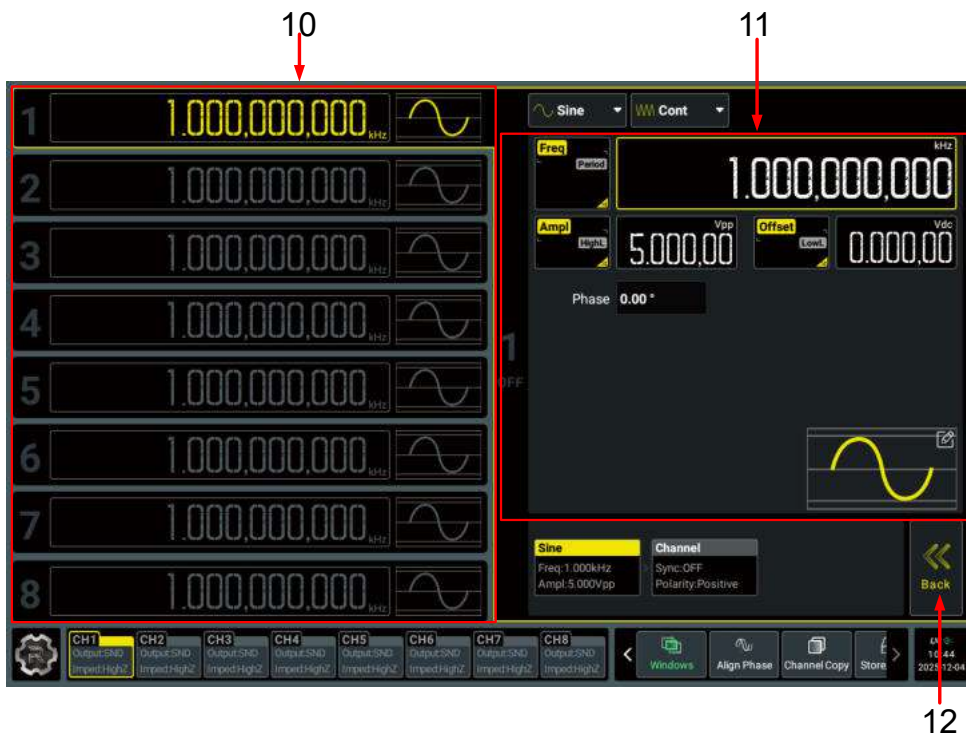

Figure 4.13 8-Channel Display Mode Parameter Setting Interface

---

|   |  |    |                              |
|---|--|----|------------------------------|
| 1 | Channel Identifier                                       | 7  | Function Keys                |
| 2 | Waveform Parameter Selection Keys                        | 8  | Channel Labels               |
| 3 | Channel Parameter and Waveform<br>Thumbnail Display Area | 9  | Function Navigation Icon     |
| 4 | Waveform Parameter Display/<br>Setting Area              | 10 | Channel List                 |
| 5 | Parameter Setting Key                                    | 11 | Parameter Configuration Area |
| 6 | Notification Area  | 12 | Back Key                     |

## 5 To Prepare for Use

### 5.1 To Adjust the Supporting Legs

Adjust the supporting legs properly to use them as stands to tilt the instrument upwards for stable placement of the instrument as well as better operation and observation. You can also fold the supporting legs when the instrument is not in use for easier storage or shipment, as shown in the figure below.

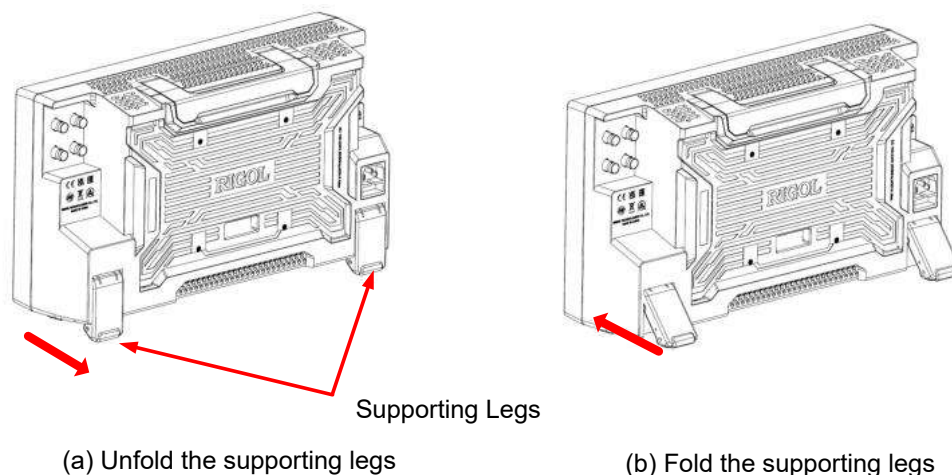

**Figure 5.1 Adjust the Supporting Legs**

### 5.2 To Connect to Power

The power requirements of this signal source are 100 V to 240 V, 50 Hz/60 Hz. Please use the power cord provided in the accessories to connect the instrument to the AC power source, as shown in the figure below.

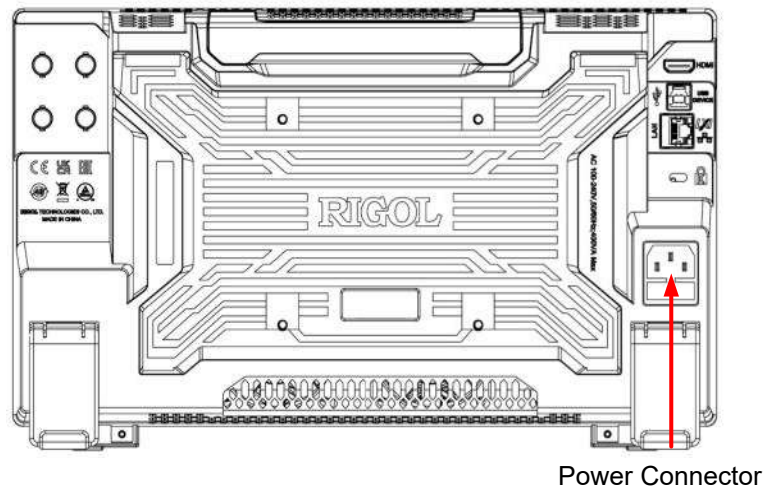

Power Connector

Figure 5.2 Connect to Power

**WARNING**

To avoid electric shock, please ensure that the instrument is correctly grounded.

## 5.3 Turn-on Checkout

After the instrument is connected to the power source, press **0** at the lower-left corner of the front panel to power on the instrument. During the start-up process, the instrument performs a series of self-tests. After the self-test, the splash screen is

displayed. You can also click or tap  > **Utility** > **Setup** to set the "Power Set" to "Auto". The instrument powers on once connected to power.

**TIP**

You can shut down the instrument in the following ways.

- Click or tap  > **Shut Down** or press the front-panel **0** and a dialog box "Do you need to shut down the instrument?" is displayed. Click or tap **Shut Down** to shut down the instrument.
- Press **0** twice to shut down the instrument.
- Press **0** for three seconds to shut down the instrument.

## 5.4 To Set the System Language

The instrument supports system languages including Chinese and English. You can click or tap  > **Utility** > **Setup** to enter the basic settings menu. Then click or tap

the **Language** drop-down button to set the system language to "Simplified Chinese", "Traditional Chinese", or "English".

## 6 To Use the Built-in Help System

---

The built-in help file provides information about the functions and menu

introductions of the instrument. Click or tap  > **Help** to enter the help system.

In the help system, you can get its help information by clicking on or tapping the link for the specified chapter.

## 7 To Use the Security Lock

If necessary, you can lock the instrument to a fixed location by using a standard laptop security lock (please purchase it by yourself), as shown in the figure below.

The method is as follows: align the lock with the lock hole and plug it into the lock hole vertically, turn the key clockwise to lock the instrument, and then pull the key out.

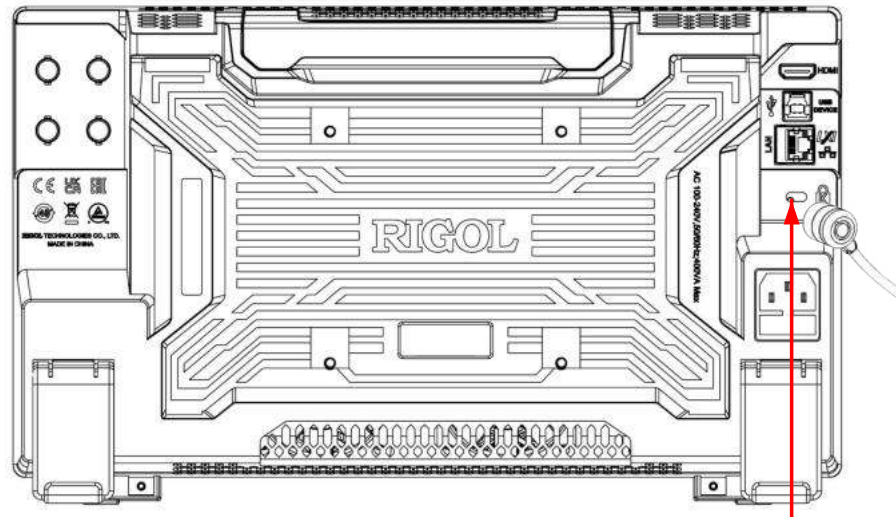

Security Lock Hole

Figure 7.1 Use the Security Lock



### CAUTION

Please do not insert other objects into the security lock hole to avoid damaging the instrument.

## 8 Parameter Setting Method

This instrument allows you to use the front-panel parameter input area and the touch screen to set parameters for the instrument.

### 8.1 To Set Parameters with the Front-panel Keys and Knobs

You can use the front-panel parameter input area to set some parameters of the instrument. The parameter input area consists of a knob, a numeric keyboard, unit selection keys, and arrow keys, as shown in the figure below.





#### Knob



You can rotate the knob to move the cursor and navigate through the menu items. Then perform the following operations:

- **If the cursor selects a parameter input field**, you can press the knob to enter the parameter editing mode. You can use the arrow keys to move the cursor. When the cursor selects the digit place, rotate the knob to make the value at the cursor +1 (clockwise) or -1 (counter-clockwise). When the cursor selects the unit, rotate the knob to make the parameter overall  $\times 10$  (clockwise) or  $\div 10$  (counter-clockwise). Press the knob again to confirm the parameter setting and disable the parameter editing mode.
- **If the cursor selects a drop-down button**, you can press the knob to expand the drop-down menu and then rotate the knob to select a parameter in the menu. After that, press the knob again to confirm your selection and collapse the drop-down menu.







- **If the cursor selects a key, on/off switch, or tab control**, pressing the knob is equivalent to tapping the corresponding key, on/off switch, or tab control using the touch screen.

### Numeric Keyboard

The numeric keyboard is composed of numeric keys (from 0 to 9), the decimal point, and symbol keys. If the current cursor selects the input field, you can press the numeric key to input a number; press <sup>A</sup>  to input "."; press <sup>B</sup>  to input "-" or "+". When using the numeric keyboard, you can also perform the following operations:













- Press the knob to confirm the input.
- Press  to delete characters.
- Press  to cancel the input.

### TIP

When inputting hexadecimal characters, use <sup>A</sup> , <sup>B</sup> , <sup>C</sup> , <sup>D</sup> , <sup>E</sup> , or <sup>F</sup>  to input "A", "B", "C", "D", "E", or "F" respectively.

### Unit Selection Keys



When setting a parameter with the numeric keyboard on the front panel, you can use the keys to select the unit of the parameter.

- <sup>C</sup> : sets the parameter unit to the default one. For example, when setting the phase, press  > <sup>C</sup>  to set the phase to 1°; when setting the frequency, press  > <sup>C</sup>  to set the frequency to 1 Hz.
- <sup>D</sup> , <sup>E</sup> , <sup>F</sup> : when setting the frequency/impedance, use the unit (k/M/G) before "/"; when setting the time/amplitude range/offset, use the unit (m/μ/n) after "/". For example, when setting the frequency, press  > <sup>D</sup>  to set the frequency to 1 kHz; when setting the period, press  > <sup>D</sup>  to set the period to 1 ms.

### TIP

When the set value exceeds the limit value, the instrument automatically adjusts the parameter to meet the requirements.

### Arrow keys

- In normal mode, you can use the keys to move the cursor to select the desired menu item. It is equivalent to rotating the knob.
- In parameter editing mode, you can use the keys to select the digit place to be modified. If the focus cursor is in the leftmost data place of the parameter, press  to left pad the parameter with zeros.
- When inputting parameters using the numeric keyboard,  is used to delete the character while  is used to cancel the input and close the input field.

## 8.2 To Set Parameters with the Touch Screen

For this instrument, you can use the touch screen function to set all of its parameters. Click or tap the parameter input field and a virtual keypad will be displayed. You can use the pop-up keypad to complete your parameter setting. The method of using the virtual keypad is as follows.

### Input a Value

When setting or modifying a function parameter, you can input an appropriate value with the numeric keypad.

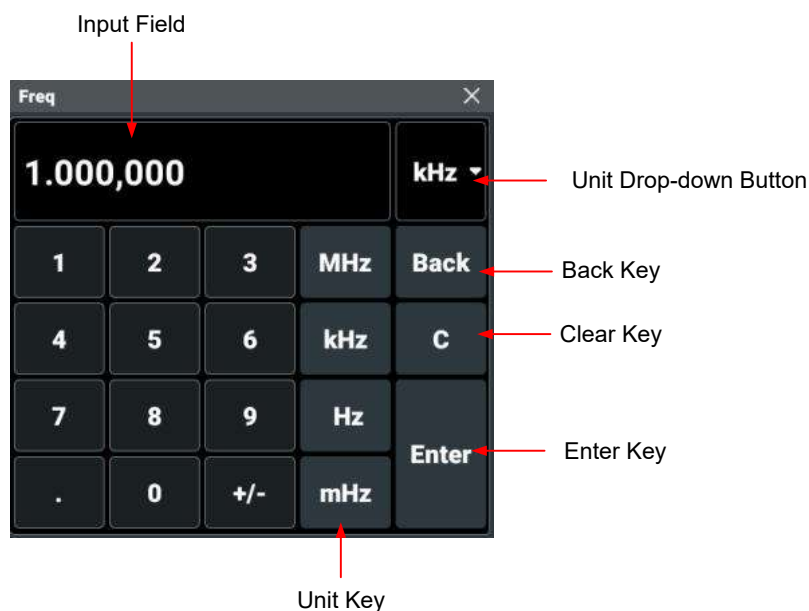

**Figure 8.1 Numeric Keypad**

Use the numeric keys in the numeric keypad to input a value. Then select the desired unit, and the numeric keypad is turned off automatically. This indicates that you have completed the parameter setting. The unit drop-down menu includes all available units. You can also click or tap the unit drop-down button to select the desired unit

when multiple units are available. Then click or tap "Enter" to confirm input and close the numeric keypad.

## 9 To Replace the Fuse

If you need to replace the fuse, please use the proper fuse (AC 250 V, T5 A; 5.2 mm×20 mm) and follow the steps shown below (see [Figure 9.1](#)).

1. Power off the instrument and remove the power cord.
2. Insert a small straight screwdriver into the slot at the power socket and pry out the fuse holder gently.
3. Remove the fuse.
4. Insert the proper fuse into the fuse holder.
5. Re-insert the fuse holder into the power socket.

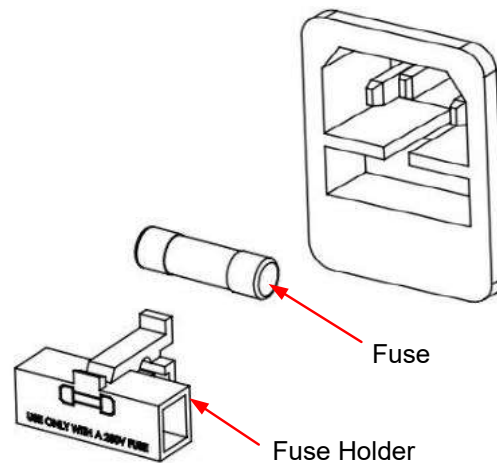

Figure 9.1 Replace the Fuse



### WARNING

To avoid electric shock, please make sure that the instrument is powered off and disconnected from the power before replacing the fuse. Also, please make sure the fuse is consistent with the required fuse rating.

## 10 Remote Control

---

The following ways of remote control are supported:

- **User-defined Programming**

Users can program and control the instrument by using the SCPI (Standard Commands for Programmable Instruments) commands. For details about the SCPI commands and programming, refer to *Programming Guide* of this product series.

- **PC Software**

You can use the PC software to send SCPI commands to control the instrument remotely. RIGOL Ultra Sigma is recommended. You can download the software from RIGOL official website (<http://www.rigol.com>).

**Operation Procedures:**

- Set up communication between the instrument and PC.
- Run Ultra Sigma and search for the instrument resource.
- Open the remote command control panel to send commands.

- **Web Control**

This instrument supports Web Control. You can view the display of the real-time interface of the instrument using Web Control. Through the Web Control method, you can migrate the device control to the control terminals (e.g. PC, Mobile, iPad, and other smart terminals) to realize remote control of the instrument. Connect the instrument to the network, then input the IP address of the instrument into the address bar of the browser of your computer. When mDNS is enabled, you can also input "hostname.local" to use Web Control. You have to log in before using the Web Control to modify network settings. When you first log in to the Web Control, the user name is "admin" and password is "rigol".

This instrument can be connected to the PC via the USB and LAN interface to set up communication and realize remote control through the PC.



**CAUTION**

**Before connecting the communication cable, please turn off the instrument to avoid causing damage to the communication interfaces.**

# 11 Troubleshooting

---

## **1. When I power on the instrument, the instrument stays black and does not display anything.**

- a. Check whether the power supply has been connected correctly.
- b. Check whether the power key is really pressed.
- c. Check whether the fuse is blown. If you need to replace the fuse, use only the specified fuse that conforms to the product.
- d. Restart the instrument after finishing the above inspections.
- e. If the problem still persists, please contact RIGOL.

## **2. The settings are correct but no waveform is generated.**

- a. Check whether the output cable is connected to the corresponding channel output terminal tightly.
- b. Check whether the output cable works properly.
- c. Check whether the output cable is connected to the test instrument tightly.
- d. If the problem still persists, please contact RIGOL.

## **3. The USB storage device cannot be recognized.**

- a. Check whether the USB storage device can work normally when connected to other instruments or PC.
- b. Make sure that the USB storage device is FAT32, NTFS, or exFAT type. The instrument doesn't support hardware USB storage device.
- c. After restarting the instrument, insert the USB storage device again to check whether it can work normally.
- d. If the USB storage device still cannot work normally, please contact RIGOL.

## **4. Performance verification test is failed.**

- a. Check whether the generator is within calibration period (1 year).
- b. Check whether the generator has been warmed up for at least 30 minutes before the test.
- c. Check whether the generator is under the specified temperature.
- d. Check whether the test is under strong-magnetism environment.
- e. Check whether the power supplies of the generator and test system have a strong interference.

- f. Check whether the performance of the test device used meets the requirement.
  - g. Make sure that the test device used is within the calibration period.
  - h. Check whether the test device used meets the required conditions of the manual.
  - i. Check whether all the connections are tight.
  - j. Check whether any cable has internal damage.
  - k. Make sure that the operations conform to settings and processes which are required by the performance verification manual.
  - l. Check whether the error calculation has faults.
  - m. Correctly understand the definition of "typical value" for this product: the performance specification of this product under specified conditions.
- 5. The touch-enabled operation does not work.**
- a. Check whether you have locked the touch screen. If yes, unlock the touch screen.
  - b. Check whether the screen or your finger is stained with oil or sweat. If yes, please clean the screen or dry your hands.
  - c. Check whether there is a strong magnetic field around the instrument. If the instrument is close to the strong magnetic field (e.g. a magnet), please move the instrument away from the magnet field.
  - d. If the problem still persists, please contact RIGOL.

## 12 More Product Information

---

### 1. Obtain the Device Information

Click or tap  > **Utility** > **About** to obtain the information of this instrument, such as the model, serial number, and hardware version number. You can also click or tap the notification area at the lower-right corner of the screen and obtain the information by clicking or tapping **About** in the pop-up **Utility** menu.

### 2. View the Option Information and Install the Option

Click or tap  > **Utility** > **Options** to view the information of all options. For how to install the option, see the detailed descriptions in the User Guide of this product.

For more information about the instrument, refer to the relevant manuals by logging in to the official website of RIGOL (<http://www.rigol.com>) to download them.

- *DG6000 User Guide* introduces the functions of the instrument and the operation methods, remote control methods, possible failures and solutions in using the instrument, specifications, and order information.
- *DG6000 Programming Guide* provides detailed descriptions of SCPI commands and programming examples of the instrument.
- *DG6000 Data Sheet* provides the main features and technical specifications of the instrument.

# Boost Smart World and Technology Innovation

Industrial Intelligent  
Manufacturing



Semiconductors



Education &  
Research

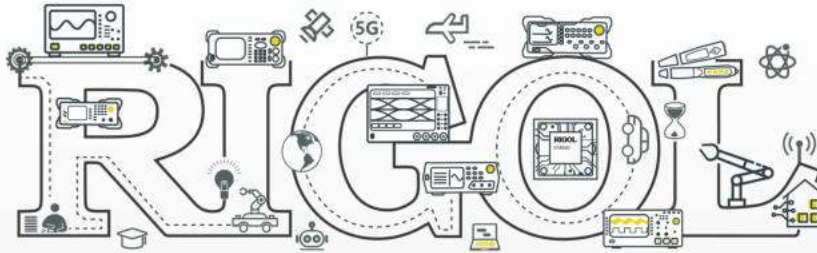

Communication

System Integration



New Energy



- 5G Cellular-5G/WIFI
- UWB/RFID/ ZIGBEE
- Digital Bus/Ethernet
- Optical Communication

- Digital/Analog/RF Chip
- Memory and MCU Chip
- Third-Generation Semiconductor
- Solar Photovoltaic Cells

- New Energy Automobile
- PV/Inverter
- Power Test
- Automotive Electronics

*Provide Testing and Measuring Products  
and Solutions for Industry Customers*

## HEADQUARTER

**RIGOL TECHNOLOGIES CO., LTD.**  
No.8 Keling Road, New District,  
Suzhou, JiangSu, P.R.China  
Tel: +86-400620002  
Email: info-cn@rigol.com

## JAPAN

**RIGOL JAPAN CO., LTD.**  
5F, 3-45-6, Minamiotsuka, Toshima-Ku,  
Tokyo, 170-0005, Japan  
Tel: +81-3-6262-8932  
Fax: +81-3-6262-8933  
Email: info.jp@rigol.com

## EUROPE

**RIGOL TECHNOLOGIES EU GmbH**  
Friedrichshafener Str. 5  
82205 Gilching  
Germany  
Tel: +49(0)8105-27292-21  
Email: info-europe@rigol.com

## KOREA

**RIGOL KOREA CO., LTD.**  
5F, 222, Gonghang-daero,  
Gangseo-gu, Seoul, Republic of Korea  
Tel: +82-2-6953-4466  
Fax: +82-2-6953-4422  
Email: info.kr@rigol.com

## NORTH AMERICA

**RIGOL TECHNOLOGIES, USA INC.**  
10220 SW Nimbus Ave.  
Suite K-7  
Portland, OR 97223  
Tel: +1-877-4-RIGOL-1  
Email: sales@rigol.com

## For Assistance in Other Countries

Email: info.int@rigol.com