



APM TECHNOLOGIES

PROFESSIONAL INNOVATIVE BRANDING SERVICE

en.apmtech.cn

High Power DC Load

User Manual >>>



Contents

Preface	05
Safety Notices	06
1 About this Manual	07
1.1 Scope	07
1.2 Targeted Audience	07
1.3 Use of this Manual and Legal Notices	07
2 Unpacking	08
2.1 Packing List	08
2.2 Checking for Shipping Damage	09
2.3 Failure Repair	09
3 Products Introduction	10
3.1 Product Description	10
3.2 Product Features	10
3.3 Operation Instructions	11
3.4 Operation Environments	11
3.5 Maintenance and Cleaning	11
3.6 Product Storage	11
3.7 Power Supply Voltage	12
3.8 Fuse	12
3.9 Warm-up Time	12
3.10 Starting Procedure	12

4 Panel Description	13
4.1 Front Panel Description	13
4.2 Rear Panel Description	15
5 Menu Operation	16
5.1 Menu Introduction	16
5.1.1 Menu Structure	16
5.1.2 Introduction to Front Panel Operations	18
5.1.3 Keys, Rotary Knob and Touch Screen Operations	18
5.2 Menu Operation.....	21
5.2.1 Menu Introduction	21
5.2.2 Load	22
5.2.2.1 Constant Current Mode	22
5.2.2.2 Constant Voltage Mode	23
5.2.2.3 Constant Resistance Mode	24
5.2.2.4 Constant Power Mode	25
5.2.2.5 Dynamic Current Mode	26
5.2.2.6 Dynamic Voltage Mode	27
5.2.2.7 Dynamic Resistance Mode.....	28
5.2.2.8 Dynamic Power Mode.....	29
5.2.3 Advanced	30
5.2.3.1 BATT (Battery Discharge Timer)	30
5.2.3.2 OCP/OPP	31
5.2.3.3 Program setting program sequence function	32
5.2.3.4 CV-CC	34
5.2.3.5 CV-CR	35
5.2.3.6 CR-CC	35
5.2.3.7 Auto	36
5.2.3.8 LED	37

5.2.4 Configure.....	37
5.2.4.1 Load Setup.....	37
5.2.4.2 Protection	39
5.2.4.3 Paral/Sync	39
5.2.4.4 SPEC	40
5.2.4.5 Digitizing	41
5.2.4.6 Timing	41
5.2.5 Save/Recall	41
5.2.6 Warning	41
5.2.7 System Settings	41
5.2.7.1 Settings.....	42
5.2.7.2 Date	42
5.2.7.3 RS232/485	42
5.2.7.4 TTL/Analog.....	43
5.2.7.5 LAN.....	43
5.2.7.6 GPIB	44
5.2.7.7 Info	44
5.2.7.8 Factory	44
5.2.7.9 Calibrate	44
5.2.7.10 Upgrade	44
6 Parallel Operation	45
6.1 Parallel Procedure	46

7 Installation 47

 7.1 Overview and Dimensions 47

 7.2 AC Input connection 48

 7.3 Load Connection 49

 7.4 Remote Sensing Connections 50

8 Troubleshooting 53

9 Recycling and Disposal 54

10 Contact Us 54

Appendix A Specifications 55

Appendix B Warranty 108

Issue PB (2020-04)

 Preface

Dear Customer,

Thank you for using this series High Power DC load, a product developed & manufactured by APM Technologies. We sincerely hope this product can meet your needs.

The sections outlined in this user manual are suitable for the following product models.

Height	Power	200V	600V	1200V	Flippable Front Panel
1/2 2U	300W	30A	20A	*	NO
	600W	60A	35A	*	NO
2U	1.2kW	130A	90A	45A	NO
	1.8kW	190A	130A	*	NO
	2.4kW	260A	180A	90A	NO
	3.0kW	320A	220A	*	NO
3U	3.4kW	370A	250A	125A	NO
	4.4kW	480A	320A	160A	NO
	5.6kW	610A	410A	210A	NO
4U	6.6kW	720A	480A	240A	YES
7U	8.8kW	960A	640A	320A	YES
	11kW	1200A	800A	400A	YES
	13.2kW	1440A	960A	480A	YES
10U	15.4kW	1680A	1120A	560A	YES
	17.6kW	1920A	1280A	640A	YES
	19.8kW	2160A	1440A	720A	YES
13U	22kW	2400A	1600A	800A	YES
	24.2kW	2640A	1760A	880A	YES
	26.4kW	2880A	1920A	960A	YES

This series High Power DC load are divided into Advanced Version and Professional Version according to different application area. Below is the difference between two versions.

NO.	Description	Single unit (Professional version)	Single unit (Advanced version)
1	Dynamic frequency sweep function	Supported	Not supported
2	Sine wave dynamic load	Supported	Not supported
3	High speed sampling rate	Supported	Not supported
4	Non linear load	Supported	Not supported
5	User defined waveform	Supported	Not supported
6	MPPT	Supported	Not supported
7	External waveform control	Supported	Not supported
8	Parallel mode	20pcs	10pcs

Safety Notices



Warning!

This symbol highlights operations that have the potential to endanger users, operation procedures and instructions must be completely understood before use.



Caution!

Documentation must be consulted in all cases where this symbol is marked.



Note

This symbol highlights important instructions that need to be read before using the equipment.



This symbol indicates of high voltage risk aspects of the product or its use.



This symbol indicates parts that may be at a high temperature. Please do not touch this part of the equipment to prevent scalding.



This symbol indicates that a grounded condition is required before operating the equipment; the terminal with this label must be grounded to prevent electric shock.

If the equipment is used in a manner not specified by the manufacturer, the protection provided by the equipment may be impaired.

1

About this Manual

1.1 Scope

This manual provides the reader with detailed product information as well as installation, operation and maintenance instructions. This manual also provides our company contact information so that you can tell us your suggestions and comments about the performance of our products in order that we can continue to improve our product quality and our level of service.

1.2 Targeted Audience

This manual is intended for product users and technical personnel that are involved with installing, operating and maintaining the product. Readers are required to have a certain degree of electrical and mechanical knowledge and be familiar with basic electrical and mechanical schematics.

1.3 Use of this Manual and Legal Notices

All materials (including but not limited to graphics, logos, symbols, data, etc.) in this manual are owned by the APM Technologies. No part of this manual can be reproduced without prior authorization from APM Technologies.

The content of this manual will continue to be updated and revised as inevitably there are slight discrepancies or errors. Please check for updates at en.apmtech.cn and download the latest version of this manual and information.

It is prohibited in any way to use all or part of the firmware or software developed by APM Technologies for other commercial purposes. It is prohibited to decompile, decrypt or otherwise damage the software developed by APM Technologies.

2 Unpacking

2.1 Packing List

Item	Description	Quantity	Remarks
A	High Power DC Load	1	As ordered
B	Rack Mount Brackets	2	Standard
C	DC input protective cover	1	Standard
D	Screws	1bag	Fasten item B
E	BNC cable	2	Standard
F	USB communication cable	1	Standard
G	RS-232 communication cable	1	Standard
H	Sense line (Red)	1	Standard
I	Sense line (Black)	1	Standard
J	System bus communication cable	1	Standard
K	GPIB communication cable	1	Optional
L	LAN communication cable	1	Optional
M	Power wire	1	Standard
N	GPIB&LAN communication card	1	Optional
O	Quick guide	1	English Version

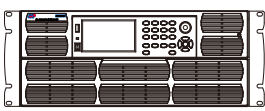

A

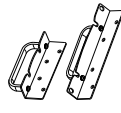

B



C



D



E



F



G



H



I



J



K



L



M

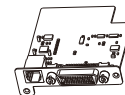

N



O

2.2 Checking for Shipping Damage

All APM Technologies Company products have undergone stringent testing before delivery, but inevitably damage can happen during transportation. Once you receive the product, please immediately check if there is any packaging damage that may indicate damage to the product. If you find damage related to product delivery, please immediately notify the transport company. Make sure to take photos documenting the damage to the product, and send them to us so that we can provide you with the best service.



Caution!

- The handles on the front panel are for sliding in and out of the cabinet NOT for carrying.
- Because of its weight, transport by hand should be avoided where possible. If unavoidable then only the housing should be held and not on the exterior parts (handles, input/output terminals or rotary knobs).

2.3 Product Damage or Failure Repair

In the unlikely event of product failure, please promptly contact APM Technologies or its dealer and provide the serial number of the faulty DC loads, detailed fault information and pictures to help us identify the cause of the failure. If the power source requires repairing at the factory or repair center, please pack it in the original packing material. Please assure to contact APM to receive prior authorization for the product return and return instructions.

3 Products Introduction

3.1 Product Description

This series E-loads provide CC, CV, CP, CR, CZ and dynamic load operation modes commonly used for performance and burn-in test of power supply. Full protection including OCP, OPP, OTP, over voltage and reverse alarm. Support external control and monitor mode, the 0 to 10V input or output signal represent 0 to full range voltage or current. Standard RS232/RS485/USB communication interfaces, LAN & GPIB communication card is optional. Support power expanding by master-slave paralleling.

3.2 Features

- Flippable front panel and color touch screen allow convenient access and operation.
- Provides four kinds of basic working mode such as CV/CC/CR/CP, and CV+CC/CV+CR/CR+CC complex operating modes.
- Adjustable current slew rate, adjustable CV loop speed.
- Ultra high precision voltage & current measurement.
- OCP/OPP testing function.
- 50kHz high-speed CC/CR dynamic mode.
- 500kHz high-speed voltage and current sampling rate.
- Timing & discharging measurement for batteries.
- Short circuit test mode.
- Auto mode function provides an easy way to do complicated test.
- Dynamic frequency sweep function for determining worst case voltage peaks.*
- Non linear load mode function makes the simulated loading current more realistic.*
- Supports external analog control function.*
- V-monitor/I-monitor.
- LED load simulation function.
- Full protection: OCP, OPP, OTP, over voltage and reverse alarm.
- Up to 20 units master/slave parallel control.
- Front panel USB interface supports data import and export.
- SCPI language and standard rack size make it ideal for ATE System intergration.
- Smart fan control with lower noise and better for environment.
- Multi versions to meet the cost performance and different applications.

* Only professional Electronic Load units support these functions.

3.3 Operating Instructions

This product is a precision instrument, please read this manual carefully before using. In order to ensure measurement accuracy it is recommended that this unit is calibrated annually by a calibration laboratory.

To ensure the user safety, the input power cable, connector and accessories of this product should be inspected at least annually.

3.4 Operating Environments

1. This series E-Loads must be used in a clean and dry lab or testing environment with an ambient temperature of between 0°C and 40°C and a relative humidity of between 5% and 95%.
2. Do not use this load in a high temperature ambient for a prolonged period. Long term operation at a high ambient temperature may cause OTP action.
3. It is suggested that the distance between the load and wall or other objects should be 1 meter at least due to fan forced cooling.
4. Do not operate this product in an environment that contains large amounts of dust or corrosive gases. Please do not subject the unit to strong shock and vibration or expose it to intense direct sunlight.

3.5 Product Storage

Please store this product in an area with a temperature between -20 and 85 and with a relative humidity of between 5% and 95% non-condensing. If the product is not going to be used for a long period, please pack in the original carton or other similar packaging and store it in a cool & dry place.

3.6 Maintenance and Cleaning

Before cleaning, you must disconnect the input power cord of this power source. Gently wipe off any dust from the units exterior using a brush or sponge or one can use only a small amount of non-aqueous cleaning solution such as isopropyl alcohol on a clean cloth. Do not use a corrosive or abrasive cleaning solution to clean this product. The display front panel can be cleaned with cloth dampened in soft detergent. Cleaning of dust from the interior of this product must be carried out with a low pressure air gun, and to prevent damage to internal components we suggest that such cleaning be performed by an authorized dealer on behalf of the user.

3.7 Power Supply Voltage

Make sure that the front panel switch is in the OFF state and the AC input mains voltage is within the product's operating specification before plugging in or connecting to the AC mains.



Caution!

- The protective safety earth/ground connection must be connected first and disconnected after the AC mains line and neutral wires.

3.8 Fuse

The input AC fuses installed inside the product are designed to protect the units' input from major component failures, and they should not fail under normal operating conditions. Accordingly, any fuse failure is an indication that other parts of the product are damaged. If the input fuses open circuit we recommend that the product be sent back to us for repair.



Warning!

- Danger of electric shock. No user serviceable components enclosed. Do not disassemble the load's enclosure / case to replace the fuse.

3.9 Warm-up Time

Once the power source is switched on the unit will enter a start-up routine that when completed which will verify proper unit operation. All features of the unit are operable after this routine has been successfully completed. In order to achieve the specified operating accuracy, it is recommended to allow the E-load to warm-up for a period of 30 minutes before use.

3.10 Starting Procedure

When switch on power, E-load will have a series of self test. After power on, Name of company show out.

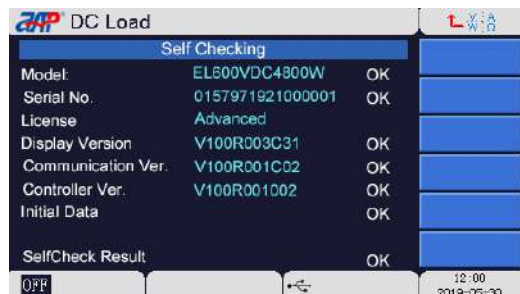

After 2 seconds, it will enter the self-checking page:

After several seconds, the LCD will display the Diagnostics screen. The diagnostics will take several seconds to complete. If all results are OK, the unit will revert to the default screen.

If there is a Fail result in any of the other tests, please contact APM technical engineer for support.





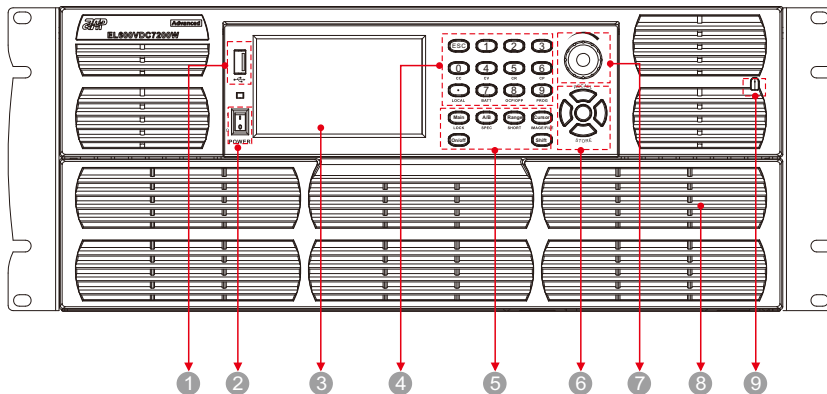





Panel Description

4.1 Front Panel Description













Front Panel-4U Models as example





- ① USB host, for data import and export
- ② Power switch
- ③ Color touch screen
- ④ Numeric keys and function keys

Keys	Name and the function	Manual Reference
	Numeric keys	[0]~[9]
 / ([LOCAL])	Decimal point key / Keypad unlock function key / Press this key to switch the control mode from remote control back to the manual operating mode	[.] / ([LOCAL])
	Esc key	[ESC]
CC (Shift + )	CC mode	[Shift]+[0]
CV (Shift + )	CV mode	[Shift]+[4]
CR (Shift + )	CR mode	[Shift]+[5]
CP (Shift + )	CP mode	[Shift]+[6]
BATT (Shift + )	Battery discharge timer	[Shift]+[7]
OCP/OPP (Shift + )	OCP or OPP test function.	[Shift]+[8]
PROG (Shift + )	Program function	[Shift]+[9]

5 Function keys and multifunction keys

Keys	Name and the function	Manual Reference
	It switches the load to A and B two types	[A/B]
	Cursor to highlight desired selection	[Cursor]
	Press to return to the Main screen	[Main]
	The loading and unloading function key	[On/Off]
SHORT (Shift + )	It simulates the short circuit function	[Shift]+[Range]
	Select alternate function of other keys as indicated by silkscreen directly below key	[Shift]
IMAGE/FILE (Shift + )	Screen snapshot/importing	[Shift]+[Cursor]
SPEC (Shift + )	It provides GO/NG to test loading specification when enabled	[Shift]+[A/B]
LOCK (Shift + )	Press to lock the front panel keys and touch screen function	[Shift]+[Main]
	Loading mode range selection	[Range]

6 Enter key and arrow keys

Keys	Name and the function	Manual Reference
RECALL (Shift + )	Recall setup from internal non-volatile memory	[Shift]+[▲]
STORE (Shift + )	Store setup to internal non-volatile memory	[Shift]+[▼]
	Used to move the cursor to the previous position	[◀]
	Used to move the cursor to the next position	[▶]
	Confirm key	[Enter]

- 7 Push-on knob, for editing parameter and moving the location of cursor
- 8 Ventilation holes
- 9 Stylus

4.2 Rear Panel Description

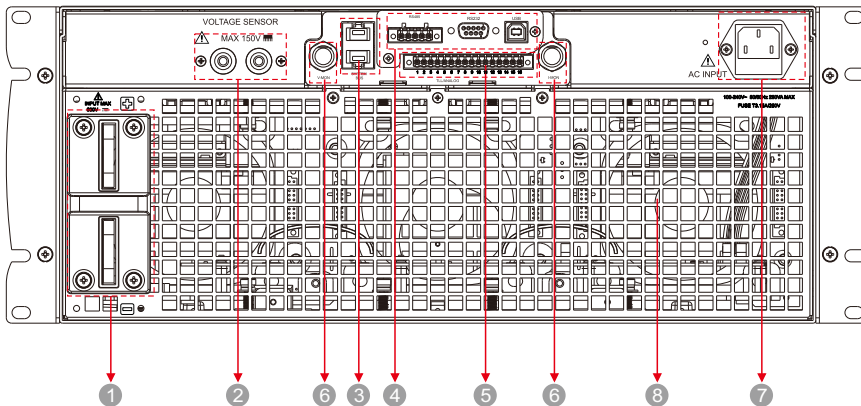

Rear Panel-4U Models as example

- 1 Load positive/negative terminal
- 2 Remote sense connections
- 3 System Bus, for mater/slave system datatransmission
- 4 RS485/RS232/USB communication Interface (standard), LAN&GPIB communication Interface (optional)*
- 5 External TTL/Analog control interface
- 6 V-monitor/I-monitor
- 7 AC input connector
- 8 Ventilation holes

* When LAN&GPIB interface card selected it will be installed here instead of RS485/RS232/USB interface card.

5 Menu operation

5.1 Menu Introduction

5.1.1 Menu Structure

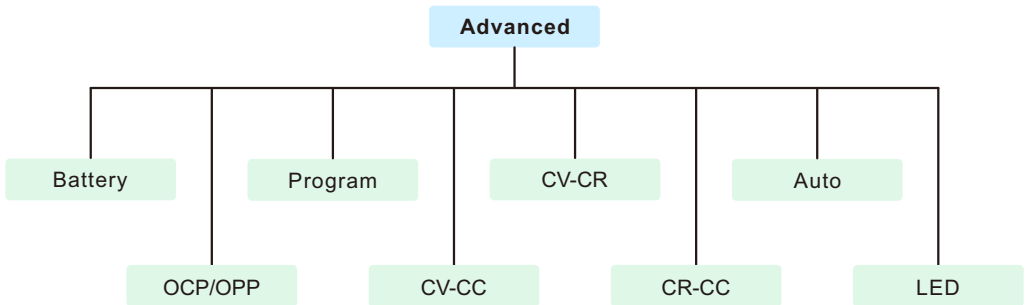
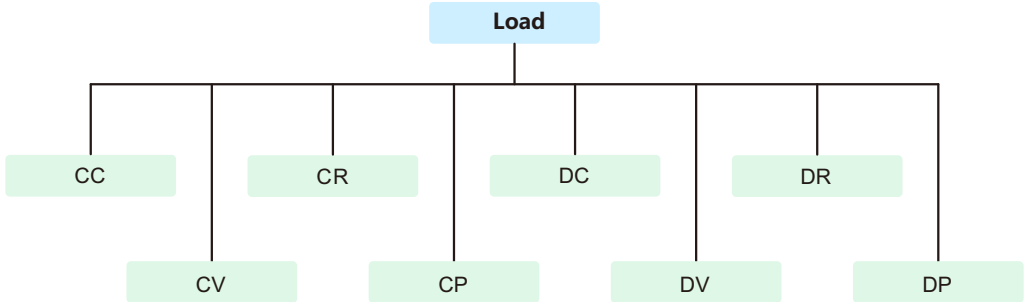
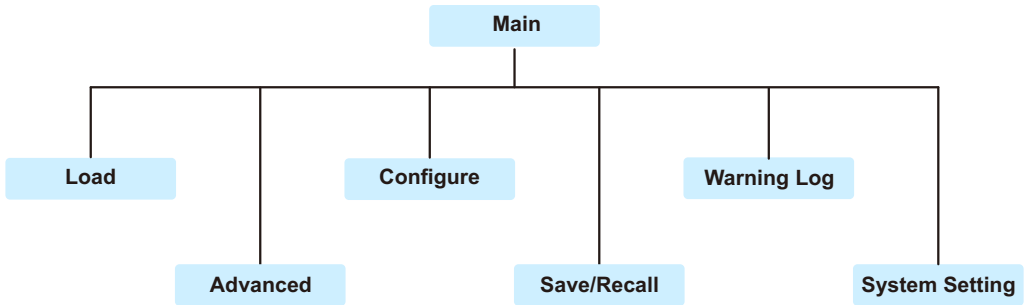

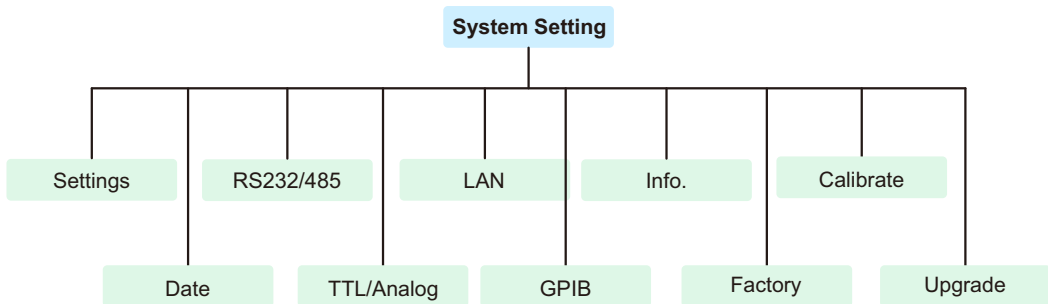
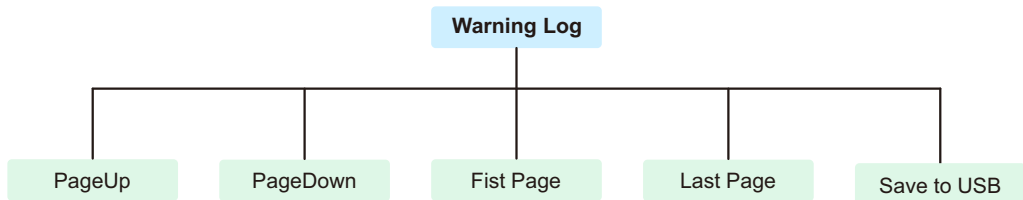
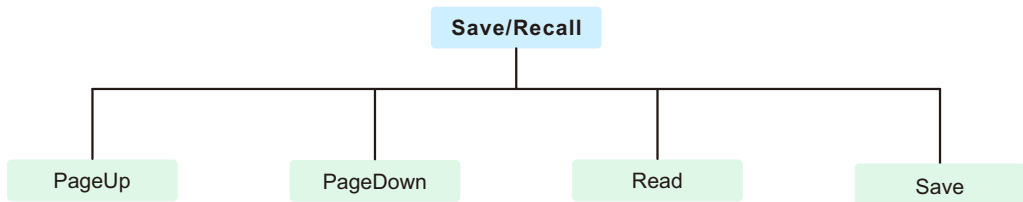
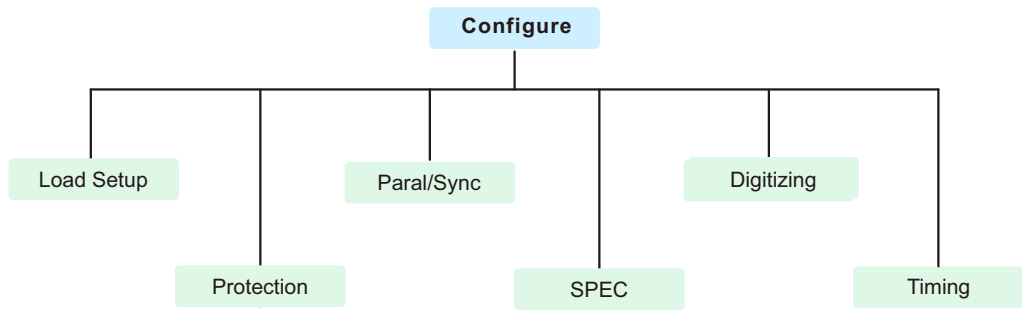

5.1.2 Introduction to Front Panel Operations

1. Front panel [ON/OFF] key is used for loading and unloading.
2. Control modes include Front Panel control, Remote control and External control, the first two can be selected by a connected computer. The operating mode can be changed without affecting the loading state.
3. All front panel keys are functional when the load is in Front Panel operation mode.
4. Under remote operation mode, all Front Panel keys except the [Local] key are locked. The [Local] key can be used for switching to local operation mode.

5.1.3 Keys, Rotary Knob and Touch Screen Operations

The examples below explain how to setup the current and select menu through keys, rotary knob and touch screen separately.

Current setting

Option one (using front panel keys)

1. Press the [Cursor] key, then press the arrow keys to move the cursor to highlight the settable parameters.
2. Press [Enter] key first when the cursor highlight the current setting, press the numeric keys [0]~[9] to set the desired value, then press the [Enter] key to confirm.

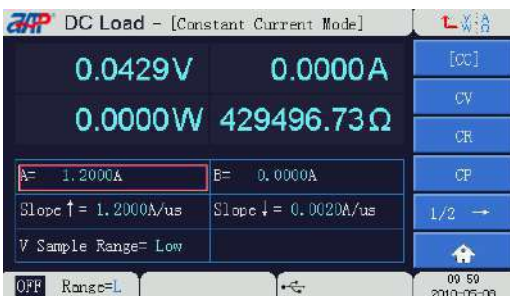

Option two (using rotary knob)

1. Press the [Cursor] key, then press the arrow keys to move the cursor to highlight the settable parameters.
2. When the cursor highlight the current setting, press the knob, the default location of the cursor is at the highest digit, turn the knob to change this digit value to increase or decrease the setting. Long press the knob for 1.5 seconds to confirm and finish the setting.



Option three (using touch screen)

1. Touch the desired value area, a small keyboard will be displayed as shown below.
2. Touch the numeric keys [0]~[9] as desired, then touch the [Enter] key on the small keyboard to confirm.



Menu setting

Option one (using front panel keys)

1. Press the [Cursor] key.
2. Press the arrow keys to move the cursor to highlight the desired option then press the [Enter] key to confirm.

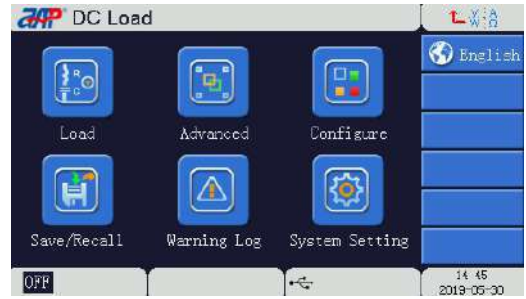

Option two (using rotary knob)

1. Press the [Cursor] key.
2. Turn the knob to move the cursor to highlight the desired option then press the knob to confirm.



Option three (using touch screen)

Touch and select the option directly.



5.2 Menu operation

We will explain menu operation using the front panel keys as touch screen operation is self-explanatory.

5.2.1 Menu introduction



- ① Current active menu of the load
- ② Measurement parameters of the load
- ③ Parameters setting area of the load
- ④ Sub-menu
- ⑤ Selects main menu
- ⑥ Current state of the load
- ⑦ Time and data
- ⑧ Shortcut key back to operation mode

5.2.2 Load

This screen allows control over the following settings using these soft keys:

- CC
- CV
- CR
- CP
- DC
- DV
- DR
- DP

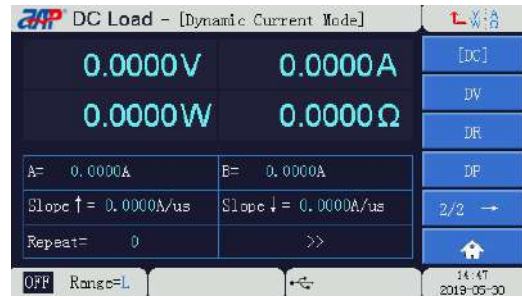
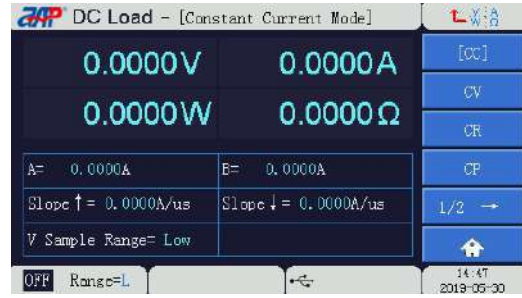

5.2.2.1 Constant Current Mode

In CC mode, the Load will sink a current in accordance with the programmed values regardless of the input voltage. To enter into CC mode, please press the [Main] key, select Load then select CC mode.

Parameters:

A: set the loading value for A load.

B: set the loading value for B load.

Slope↑: set the current rise slew rate data.

Slope↓: set the current fall slew rate data.

V Sample Range: set the voltage measurement range of Electronic Load. There are H, M and L for selection.

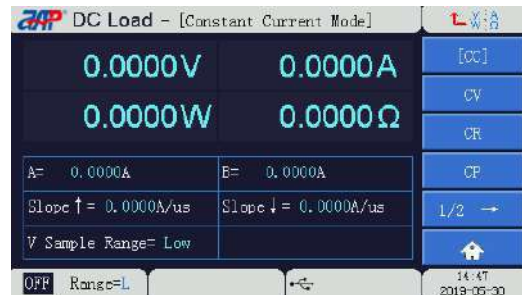

Range (Low, Middle, High)

Current could be programmed in each range, low range, middle range and high range. At low current setting, low range provides better resolution. If setting value is over maximum of low range, the user has to use middle range. If setting value is over maximum of middle range, the user has to use large range. To change range, please select Range on the screen to set. Change of mode will affect Load, so will change of the range. Both of them will cause shut down status of input. If CC mode of E-load is activated, new setting will directly change input at a rate determined by the slew rate setting.

A/B State Switch

Static function has two setting level A or B. Use the [A/B] key to manually switch between two programmed load states. Slew rate determines the rate at which load level changes from one load level state to another.

5.2.2.2 Constant Voltage Mode

In CV mode, E-load will sink current to control the voltage source in programmed value. CV mode has 3 types of response speeds: fast, normal and slow. To enter into the CV mode, please press the [Main] key, select Load then select CV mode.

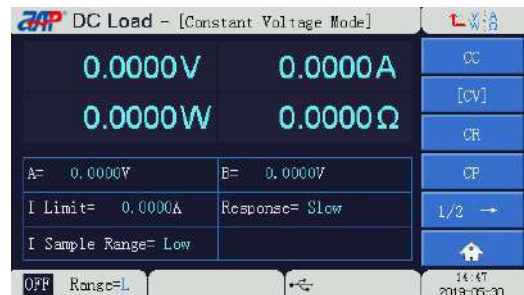

Parameters:

A: set the loading value for A load.

B: set the loading value for B load.

I Limit: set the maximum current for load.

Response: set the Electronic Load response speed to Fast, Normal or Slow.

I Sample Range: set the current measurement range of Electronic Load. There are H, M and L for selection.

Range (Low, Middle, High)

Voltage could be programmed in each range, low range, middle range and high range. At low voltage setting, low range provides better resolution. If setting value is over maximum of low range, the user has to use middle range. If setting value is over maximum of middle range, the user has to use large range. To change range, please select Range on the screen to set. Change of mode will affect Load, so will change of the range. Both of them will cause shut down status of input. If CV mode of E-load is activated, new setting will directly change input at a rate determined by the slew rate setting.

A/B State Switch

Static function has two setting level A or B. Use the [A/B] key to manually switch between two programmed load states. Slew rate determines the rate at which load level changes from one load level state to another.



Caution!

- It is suggested to use a remote sense cable to measure the UUT output voltage.

5.2.2.3 Constant Resistance Mode

In CR mode, the Load will sink a resistance in accordance with the programmed value regardless of the input voltage. To enter into CR mode, please press the [Main] key, select Load then select CR mode.



Parameters:

A: set the loading value for A load.

B: set the loading value for B load.

Slope↑: set the current rise slew rate data.

Slope↓: set the current fall slew rate data.

I Sample Range: set the current measurement range of Electronic Load. There are H, M and L for selection.

Range (Low, Middle, High)

Resistance could be programmed in each range, low range, middle range and high range. At low resistance setting, low range provides better resolution. If setting value is over maximum of low range, the user has to use middle range. If setting value is over maximum of middle range, the user has to use large range. To change range, please select Range on the screen to set. Change of mode will affect Load, so will change of the range. Both of them will cause shut down status of input. If CR mode of E-load is activated, new setting will directly change input at a rate determined by the slew rate setting.

A/B State Switch

Static function has two setting level A or B. Use the [A/B] key to manually switch between two programmed load states. Slew rate determines the rate at which load level changes from one load level state to another.



Caution!

- It is suggested to use a remote sense cable to measure the UUT output voltage.

5.2.2.4 Constant Power Mode

In CP mode, E-load will sink a power according to the programmed power. To enter into CP mode, please press the [Main] key, select Load then select CP mode.



Parameters:

A: set the loading value for A load.

B: set the loading value for B load.

Slope↑: set the current rise slew rate data.

Slope↓: set the current fall slew rate data.

V Sample Range: set the voltage measurement range of Electronic Load. There are H, M and L for selection.

Range (Low, Middle, High)

Power could be programmed in each range, low range, middle range and high range. At low power setting, low range provides better resolution. If setting value is over maximum of low range, the user has to use middle range. If setting value is over maximum of middle range, the user has to use large range. To change range, please select Range on the screen to set. Change of mode will affect Load, so will change of range. Both of them will cause shut down status of input. If CP mode of E-load is activated, new setting will directly change input at a rate determined by the slew rate setting.

A/B State Switch

Static function has two setting level A or B. Use the [A/B] key to manually switch between two programmed load states. Slew rate determines the rate at which load level changes from one load level state to another.

5.2.2.5 Dynamic Current Mode

In DC mode, the load will sink a dynamic current according to the programmed current and dynamic timing regardless of the input voltage. To enter dynamic current mode, please press the [Main] key, select Load then select DC mode.



Parameters:

A: set the loading value for A load.

B: set the loading value for B load.

Slope↑: set the current rise slew rate data.

Slope↓: set the current fall slew rate data.

Repeat: set the number of time to repeat (0 means infinite loop).

Time A: set the loading time for A.

Time B: set the loading time for B.

V Sample Range: Set the voltage measurement range of Electronic Load. There are H, M and L for selection.

Range (Low, Middle, High)

Current could be programmed in each range, low range, middle range and high range. At low current setting, low range provides better resolution. If setting value is over maximum of low range, the user has to use middle range. If setting value is over maximum of middle range, user has to use large range. To change range, please select Range on the screen to set. Change of mode will affect Load, so will change of the range. Both of them will cause shut down status of input. If DC mode of E-load is activated, new setting will directly change input at a rate determined by the slew rate setting.

5.2.2.6 Dynamic Voltage Mode

In DV mode, E-load will sink current to control the voltage according to the programmed voltage and dynamic timing. DV mode has 3 types of response speeds: Fast, Normal and Slow. To enter into DV mode, please press the [Main] key, select Load then select DV mode.



Parameters:

A: set the loading value for A load.

B: set the loading value for B load.

I Limit: set maximum current for the load.

Response: set the Electronic Load response speed to Fast, Normal or Slow.

Repeat: set the number of time to repeat (0 means infinite loop).

Time A: set the loading time for A.

Time B: set the loading time for B.

I Sample Range: Set the current measurement range of Electronic Load. There are H, M and L for selection.

Range (Low, Middle, High)

Voltage could be programmed in each range, low range, middle range and high range. At low voltage setting, low range provides better resolution. If setting value is over maximum of low range, the user has to use middle range. If setting value is over maximum of middle range, the user has to use large range. To change range, please select Range on the screen to set. Change of mode will affect Load, so will change of the range. Both of them will cause shut down status of input. If DV mode of E-load is activated, new setting will directly change input at a rate determined by the slew rate setting.

5.2.2.7 Dynamic Resistance Mode

In DR mode, the Load will sink a dynamic resistance according to the programmed resistance and dynamic timing by the input voltage. To enter into DR mode, please press the [Main] key, select Load then select DR mode.

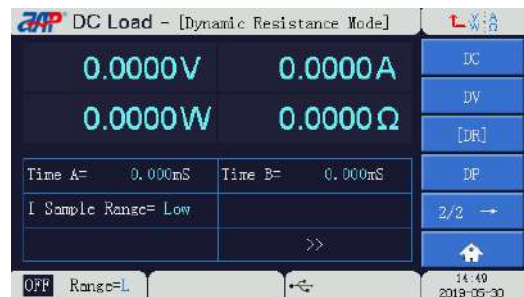

Parameters:

A: set the loading value for A load.

B: set the loading value for B load.

Slope↑: set the current rise slew rate data.

Slope↓: set the current fall slew rate data.

Repeat: set the number of time to repeat (0 means infinite loop).

Time A: set the loading time for A.

Time B: set the loading time for B.

I Sample Range: Set the current measurement range of Electronic Load. There are H, M and L for selection.

Range (Low, Middle, High)

Resistance could be programmed in each range, low range, middle range and high range. At low resistance setting, low range provides better resolution. If setting value is over maximum of low range, the user has to use middle range. If setting value is over maximum of middle range, the user has to use large range. To change range, please select Range on the screen to set. Change of mode will affect Load, so will change of the range. Both of them will cause shut down status of input. If DR mode of E-load is activated, new setting will directly change input at a rate determined by the slew rate setting.



Caution!

- It is suggested to use a remote sense cable to measure the UUT output voltage.

5.2.2.8 Dynamic Power Mode

In DP mode, E-load will sink a dynamic power according to the programmed power and dynamic timing by the input voltage. To enter into DP mode, please press the [Main] key, select Load then select DP mode.

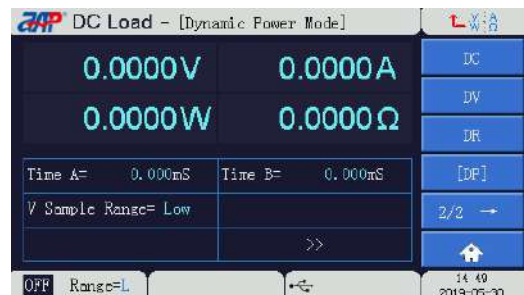

Parameters:

A: set the loading value for A load.

B: set the loading value for B load.

Slope↑: set the current rise slew rate data.

Slope↓: set the current fall slew rate data.

Repeat: set the number of time to repeat (0 means infinite loop).

Time A: set the loading time for A.

Time B: set the loading time for B.

V Sample Range: set the voltage measurement range of Electronic Load. There are H, M and L for selection.

Range (Low, Middle, High)

Power could be programmed in each range, low range, middle range and high range. At low power setting, low range provides better resolution. If setting value is over maximum of low range, the user has to use middle range. If setting value is over maximum of middle range, the user has to use large range. To change range, please select Range on the screen to set. Change of mode will affect Load, so will change of the range. Both of them will cause shut down status of input. If DP mode of E-load is activated, new setting will directly change input at a rate determined by the slew rate setting.

5.2.3 Advanced

The following useful advanced functions are available in the advanced screen:

- Battery
- OCP/OPP
- Program
- CV-CC
- CV-CR
- CR-CC
- Auto
- LED



5.2.3.1 BATT (Battery Discharge Timer)

This series load has a timer and measurement functions which can perform accurate time setting and measurement. This function allows the user to set the End Volt and Timeout during battery discharge testing and applications in similar.



Parameters:

Mode: including CC, CR and CP mode.

Set Value: set the load parameter.

Slope↑: set the current rise slew rate data.

Slope↓: set the current fall slew rate data.

End Volt: set the cut-off voltage.

Timeout: set the timeout value.

End Wh: set the cut-off Wh.

End Ah: set the cut-off Ah.

V Sample Range: set the voltage measurement range of Electronic Load. There are H, M and L for selection.

5.2.3.2 OCP/OPP

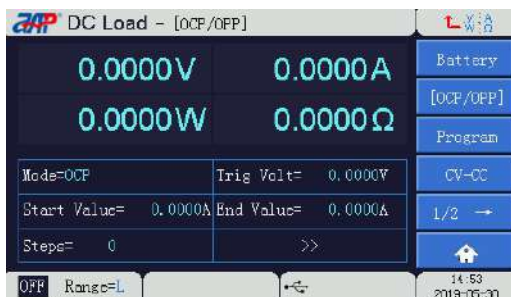

This series electronic load has over current protection (OCP) and over power protection (OPP) test function.

Which is for the load to test the UUT voltage whether has reached trigger voltage level and to judge if the protection is acting normally or not.

In OCP (OPP) test mode, the electronic load starts to load at the Start Value, and the current (power) increases step by step at regular interval. At the same time, check the load input voltage and judge whether it is higher than the Trig Volt. If higher, it indicates that OCP (OPP) does not occur. Repeat current stepping operation till the load operates to the End Value. If lower, it indicates that OCP (OPP) does occur.

Check whether the existing current (power) value is within SPEC High I (P) and SPEC Low I (P) range. If yes, display GO (Good), or NG (No Good).

SPEC High I/P: set the high level current / power.

SPEC Low I/P: set the low level current / power.

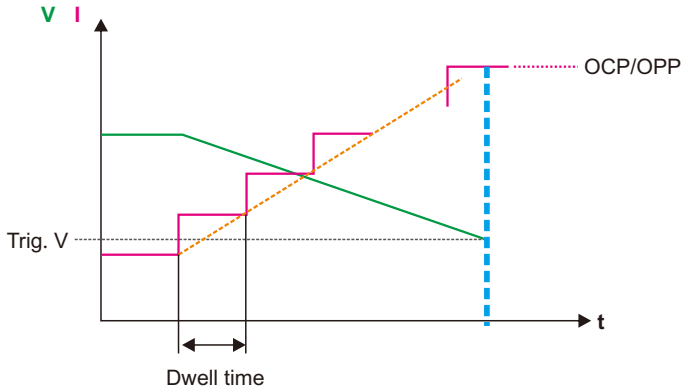

Parameters Setting:

Mode: set OCP or OPP mode.

Trigger Volt: set the trigger voltage value.

Start Value: set the starting current or power value.

End Value: set the end current or power value.

Steps: set the current or power change steps.

Time Of Step: set the dwell time.

SPEC High I: set the high level current.

SPEC Low I: set the low level current.

V Sample Range: set the voltage measurement range of Electronic Load. There are H, M and L for selection.

5.2.3.3 Program

In the program sequence function mode, the user can select the basic test of the electronic load as a program sequence and can link different program sequences for automatic execution.

Program sequences are very powerful. The electronic load consists of 10 sets of programs, including 300 sets of sequences. Users can use the program chain function to link groups of programs together to produce a variety of sequence combinations.



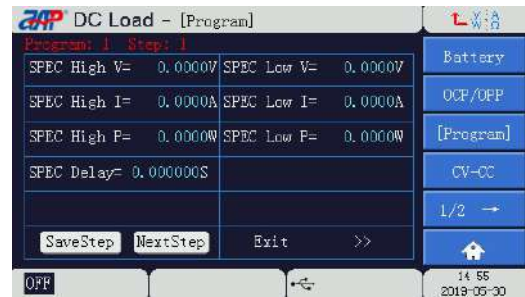
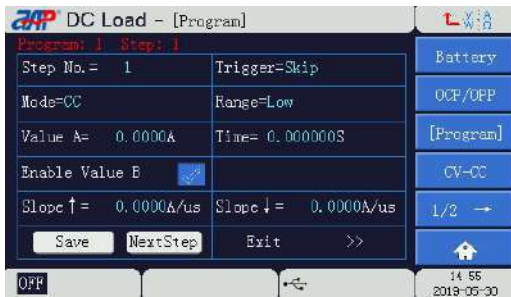

Program setting parameters:

Program No.: set the program number, 10 programs in total (1-10).

Steps: set the number of steps in a program sequence.

link: set the program chain. Program chain allows users to link programs to get more test sequences. Setting the program chain number to 0 indicates no program chain. The program chain function links itself for loop testing or links to other programs.

Repeat: set the number of times for the program chain to repeat.

Remain Steps: display the remaining unset sequence number.

Save: save edits to program to memory when done.

Set Step: set the sequence.

Step No.: set the sequence number (1-300).

Trigger: set the sequence mode to Skip, Auto, Manual or External.

Skip: skip the sequence, the load will not change the input state.

Auto: the load will run next sequence automatically when the Dwell time exceeds.

Manual: when press ENTER, the load will automatically proceed to the next sequence.

External: use external analog signal to control load input switch.

Mode: set operation mode, which includes CC, CV, CR, CP, Load off and Short mode.

Range: set the range.

Value A: set the load level.

Time: sets the sequence dwell time. The range is 0.1ms to 30s.

Enable Value B: enable this option if needed.

Slope↑: set the rising slew rate of current.

Slope↓: set the falling slew rate of current.

The electronic load allows the user to program the UUT specification for GO/NG verification in sequence. It will measure the UUT's performance for comparison when testing. The specification V, I and P can be set for the load by the user. The specification has two levels: LOW and HIGH.

SPEC High V: set high level voltage.

SPEC Low V: set the low level voltage.

SPEC High I: set the high level current.

SPEC Low I: set the low level current.

SPEC High P: set the high level power.

SPEC Low P: set the low level power.

SPEC Delay: set the Pass/Fail delay time when the load state changes.

Save Step: save the current step settings.

Next Step: switch to next step.

Exit: exit the edit page.

>>: next page.

5.2.3.4 CV-CC

In CV-CC mode, the electronic load will adjust the sink current to control the output voltage of current source by the programmed voltage.

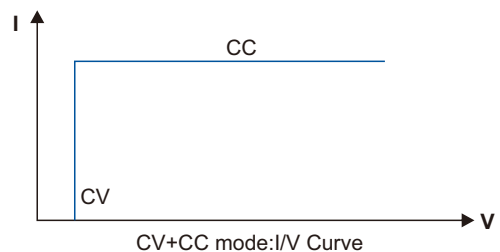

Parameters:

V_SET: set the voltage value.

I_SET: set the current value.

Response: set the electronic load response speed to Fast, Normal or Slow.

5.2.3.5 CV-CR

In CV-CR mode, program the constant voltage and constant resistance first and then start the UUT for output. When the UUT voltage starts to output, the load will sink in CV mode according to the programmed constant voltage. When the voltage rises to exceed the set constant resistance for sinking, it will switch to CR mode for sinking.

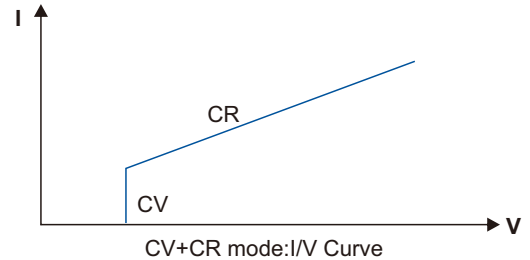

Parameters:

V_SET: set the voltage value.

R_SET: set the resistance value.



Caution!

- This mode is suggested to be used in the UUT with CV output. It is suggested to use a remote sense cable to measure the UUT output voltage.

5.2.3.6 CR-CC

In CR-CC mode, program the constant resistance and constant current first and then start the UUT for output. When the UUT voltage starts to output, the load will sink in CR mode according to the programmed resistance. When the voltage rises to exceed the set constant current for sinking, it will switch to CC mode for sinking.

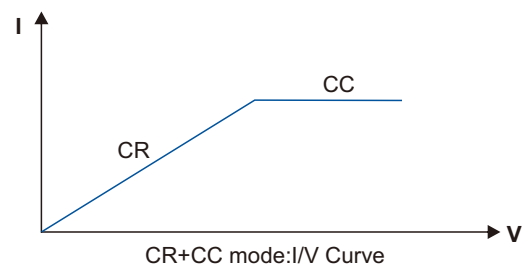

Parameters:

R_SET: set the resistance value.

I_SET: set the current value.



Caution!

- This mode is suggested to be used in the UUT with CV output. It is suggested to use a remote sense cable to measure the UUT output voltage.

5.2.3.7 Auto

In Auto mode, program the constant voltage, constant resistance, constant current and constant power, and then start the UUT for output. When the UUT voltage starts to output, the load will sink according to the programmed constant voltage in CV mode. When the voltage rises, it will automatically switch to CR mode and to the CC mode at last for sinking. It will switch to CP mode for sinking if the UUT outputs high voltage abnormally.

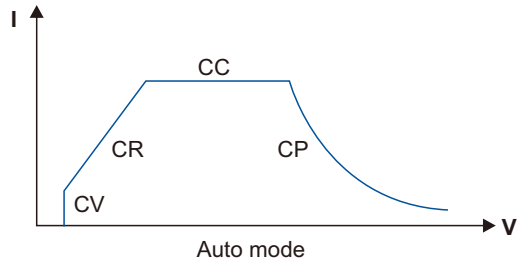

Parameters:

V_SET: set the voltage value.

R_SET: set the resistance value.

I_SET: set the current value.

P_SET: set the power value.



Caution!

- This mode is suggested to be used in the UUT with CV output. It is suggested to use a remote sense cable to measure the UUT output voltage.

5.2.3.8 LED

LED V: working voltage of load LED.

LED I: output current of LED.

Parameter: includes Rd Default, Rd Percent, Rd and Vf.

Rr: high frequency resistance.



5.2.4 Configure

The configure screen controls the following aspects of the load:

- Load Setup
- Protection
- Paral/Sync
- SPEC
- Digitizing
- Timing

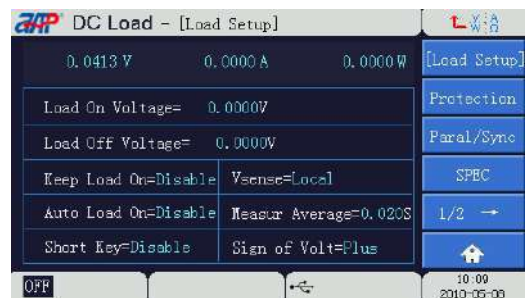

5.2.4.1 Load Setup

Load On Voltage: set the start loading voltage value.

The current will start loading when the electronic load is in ON state and the input voltage reaches the start loading voltage value.

Load Off Voltage: set the unload voltage value.

The electronic load will OFF the loading state when the input voltage is dropped to this unload voltage value. The default setting of this value is 0V.

Keep Load On: lock the start loading voltage.

Enable: means load will continue loading current when it reaches the start loading voltage level.

Disable: means loading current will stop when the input voltage is lower than the start loading voltage level.

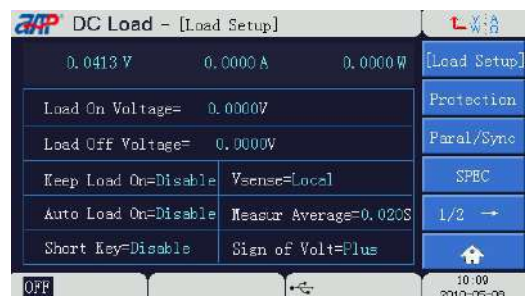



Caution!

- The electronic load can simulate the loading conditions. When the input voltage reaches the start loading voltage value, the electronic load will start or stop loading current. The load starts loading current when it is ON and the input voltage exceeds start loading voltage value. However it will stop loading when it is OFF or the input voltage is lower than the start loading voltage value. To avoid logic error, the unload voltage should be smaller than or equal to the start loading voltage value.
- If the start loading voltage value is set lower than the UUT minimum operating voltage, it could cause the UUT unable to turn on or to generate overshoot voltage or current when load is set too high. So it is necessary to consider if the UUT minimum operating voltage spec is met when setting the start loading voltage value.
- The unload value only can be used when the start loading voltage has been set. And the unload voltage setting must be lower than the start loading voltage value.

Vsense: select Local sense or Remote sense.

Auto Load On: set for auto loading when power on.

When Auto is on, the load will apply the loading parameters and mode set last time before turned off for loading when power on next time. The default setting is OFF.

Measur Average: set the average measurement time.

Short Key: set for short circuit.

The user need to set it first so that it can be controlled by the [Shift]+[Range] key on the front panel or remotely before using the short circuit function. The settings are described as below.

Hold mode: press and hold the [Shift]+[Range] to function. The short state is cleared when released.

Toggle mode: press [Shift]+[Range] key to enter into short state and press the [Shift]+[Range] key again to clear the state.



Note

- When operating in short circuit mode, the load simulates short circuit with the maximum rated current and power of the range.
- Enable the short mode will not affect the programmed settings, and the load input will return to the previous programmed value after the short mode is off.

Sign of Volt: set the positive and negative sign for the voltage.

5.2.4.2 Protection

- OCP Check:** enable or disable the OCP function.
- OCP Point:** over current protection level.
- OCP Delay:** set the OCP trip delay in secs.
- OPP Check:** enable or disable the OPP function.
- OPP Point:** over power protection level.
- OPP Delay:** set the OPP trip delay in secs.

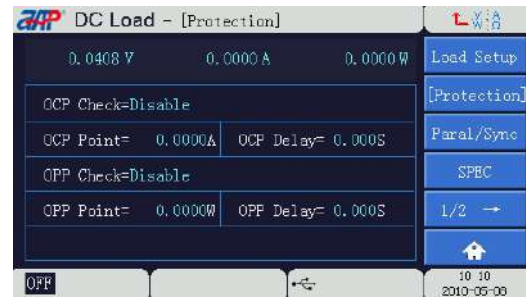

If OCP or OPP is detected, please check and make sure that the current or power passing the UUT is within the settings of the load. If exceeds the range, please disconnect and remove the UUT. The alarm information on the display will be cleared and OCP or OPP will be disabled after pressing any key on the front panel.

5.2.4.3 Paral/Sync

The electronic loads can be configured in parallel or sync mode. Set the SLAVE load first and then MASTER load. The sink settings for the slave and master units can be set in different, but the LOAD ON/OFF will only can be controlled by the MASTER one.

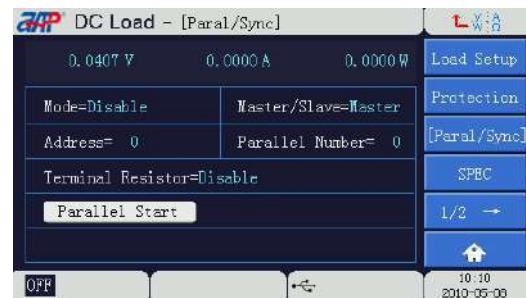

Mode: config the loads work in Parallel or Sync mode.

Master/Slave: set it as slave unit or master unit.

Address: set the communication address.

Parallel Number: set the parallel number, which must be as much as practical.

Terminal Resistor: set the terminal of the first and last unit to Enable and the rest to Disable in this system.

Parallel Start: press this soft key to enable parallel setting.

5.2.4.4 SPEC

This function allows the user to program the spec of the voltage, current and power. Enable this function during testing and the testing result can be displayed simultaneously. GO will show if the SPEC is met and NG will appear if not.

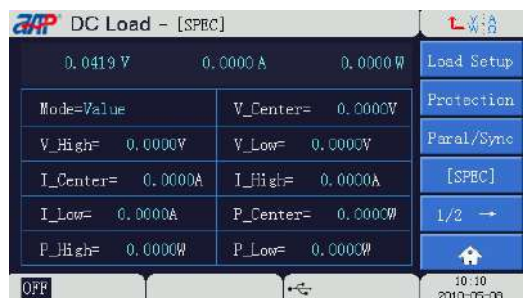

Parameters:

Mode: set Value or Percent mode.

V_Center: the setting for input reference voltage value.

V_High: the parameter setting is voltage value when the Mode is set to Value and the percentage range (0-100%) when the mode is set to Percent.

V_Low: the parameter setting is voltage value when the Mode is set to Value and the percentage range (0-100%) when the mode is set to Percent.

I_Center: the setting for input reference current value.

I_High: the parameter setting is current value when the Mode is set to Value and the percentage range (0-100%) when the mode is set to Percent.

I_Low: the parameter setting is current value when the Mode is set to Value and the percentage range (0-100%) when the mode is set to Percent.

P_Center: the setting for input reference power value.

P_High: the parameter setting is power value when the Mode is set to Value and the percentage range (0-100%) when the mode is set to Percent.

P_Low: the parameter setting is power value when the Mode is set to Value and the percentage range (0-100%) when the mode is set to Percent.



Note

- The SPEC function can be enabled for GO/NG to detect the loading specification. The user needs to press the [Shift] key first and then the [SPEC] key.

5.2.4.5 Digitizing

Sampling Time: the sampling time for measured data.

Sampling Points: the total sampling point for measured data.

Trigger Source: the trigger conditions for data capturing. Which includes Load On, Load Off, Digital Port, Key, BUS.

Trigger Point: set the trigger point.

Digitizing Start: trigger the data capturing.

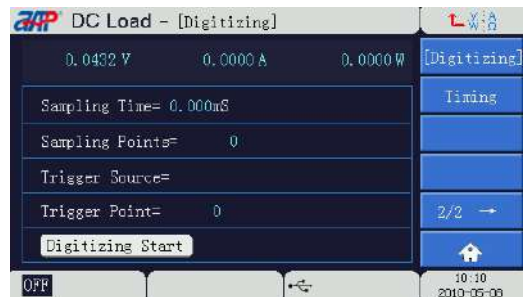

5.2.4.6 Timing

Mode: enable or disable the Timing mode.

TrigMode: set the trigger mode for starting measurement in Timing function, which includes Rise and Fall.

TrigVolt: set the voltage at the start of measurement in Timing function.

EndVolt: set the voltage at the end of measurement in Timing function.

Timeout: set the measurement timeout in Timing function.

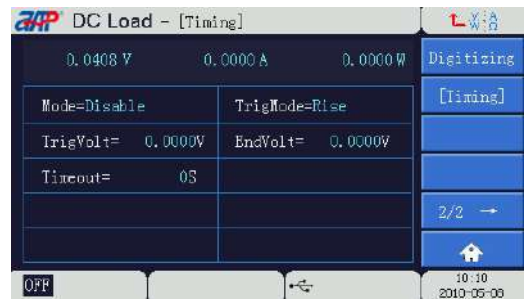

5.2.5 Save/Recall

This function is used to save and recall the commonly used parameters to or from the memory.

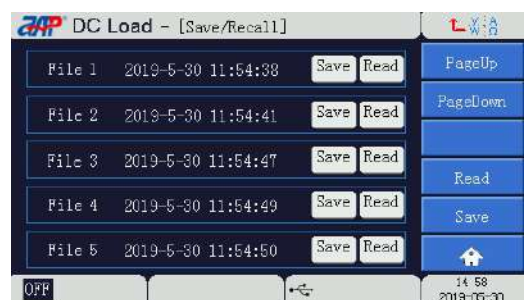

1. Press the Save soft key then enter the file name, to save the settings of all modes to a specified file (1 to 5).

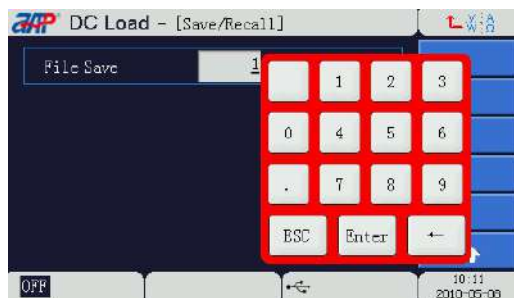

2. Press the Read soft key to recall the settings from the specified file (1 to 5).

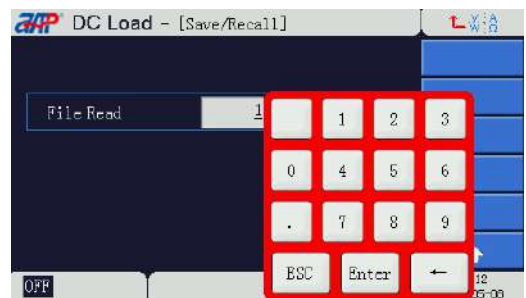

3. Select a file and press Yes soft key to delete the settings saved in this file.



5.2.6 Warning Log

This menu provides a alarm history to the user which also can be saved to a USB drive.



5.2.7 System Setting

The system setting screen is used to configure the following resources of the unit:

- Settings
- Date
- RS232/485
- TTL/Analog
- LAN
- GPIB
- Info.
- Factory
- Calibrate
- Upgrade

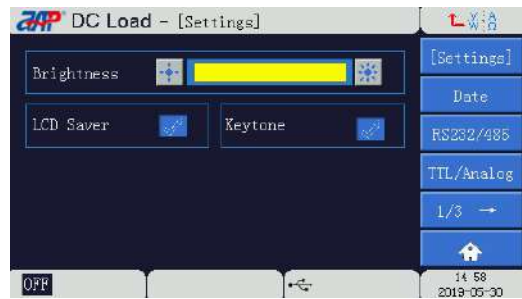

5.2.7.1 Settings

Brightness: display brightness adjustment.

LCD Saver: the display will enter power-down mode after enable this option.

Keytone: the key beeps when pressed, the default is ON.

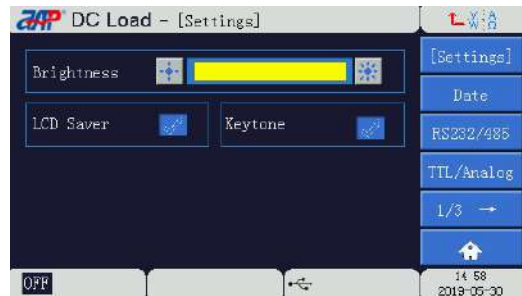

5.2.7.2 Date

It is for user to set the date and time.

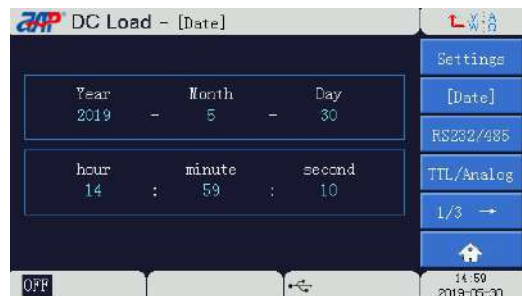

5.2.7.3 RS232/485

Communication parameters for RS232.

Baud Rate, including 9600, 19200, 38400, 57600 and 115200.

Parity, including None, Odd and Even.

Stop Bit, including 1 and 2.

Communication parameters for RS485.

Baud Rate, including 9600, 19200, 38400 and 57600 and 115200.

Parity, including None, Odd and Even.

Stop Bit, including 1 and 2.

Address, from 1 to 254.

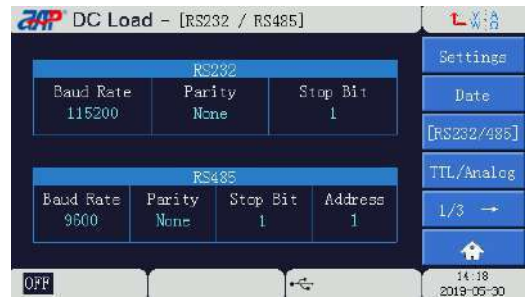

5.2.7.4 TTL/Analog

The port definitions for V-MON and I-MON.

The available options for TTL Out1, TTL Out2 and TTL Out3.

- Disable
- BattDischarge Finish(H)
- OCP/OPP Test PASS(H)
- Program Finish(H)
- SPEC Test PASS(H)
- OCP, OPP, OTP, OV, REV(H)
- BUS Control(H)

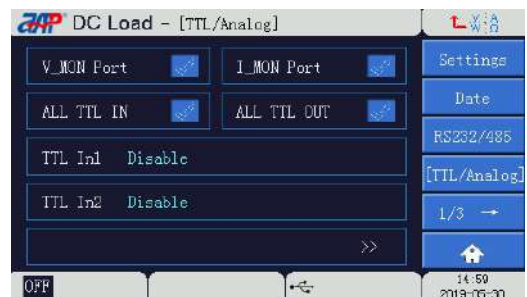

The available options for TTL In1 and TTL In2.

- Disable
- Load On(H), Load Off(L)
- Remote Inhibit(H)

5.2.7.5 LAN

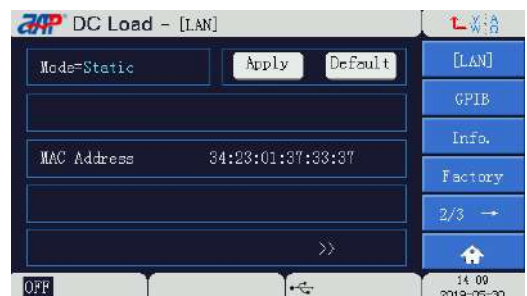
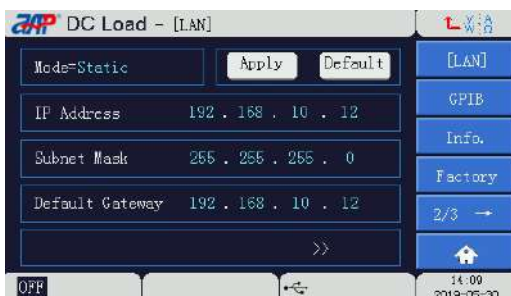

Select LAN communication mode.

Parameters:

Mode: Static or Auto. To set DCHP mode (Auto) or use Static to assigned a fixed IP address.

IP Address: set the IP address for the unit, which range is 0~255.

Subnet Mask: 0~255.

Default Gateway: 1~254.

MAC Address: display the MAC address of the unit, which cannot be edited.

Apply: press this soft key to apply all the Ethernet settings.

Default: press this soft key all the network settings will restore to default.

5.2.7.6 GPIB

It sets the GPIB address.

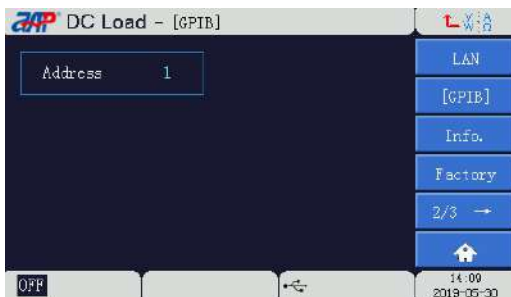

5.2.7.7 Info.

This information comprises Model, Serial No, License, Display Version, Communication Ver. and Controller Ver.

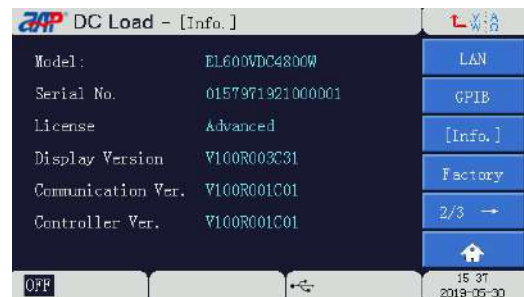

5.2.7.8 Factory

It returns to the factory default including all the settings after Yes option pressed.

Note: factory default will not clear the 10 files saved in Program menu, the Warning Log or files saved in Save/Recall menu.

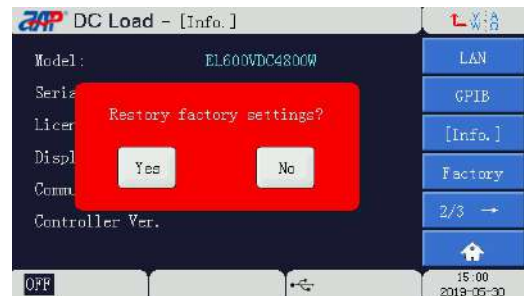

5.2.7.9 Calibrate

This menu is used for calibration, please contact APM technical support engineer if needed.

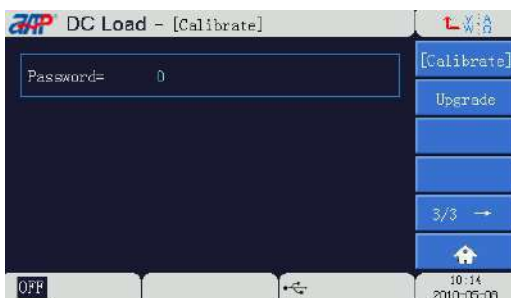

5.2.7.10 Upgrade

This screen is used to perform a firmware update, please contact APM technical engineer for support.

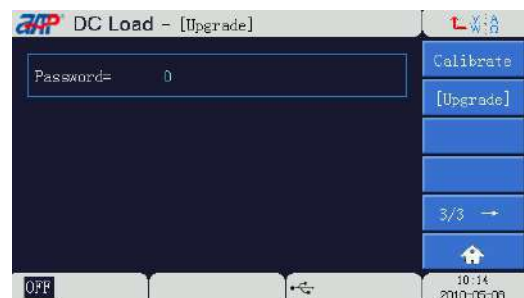

6 Parallel Operation

The series of electronic loads can be connected in parallel according to customer requirements.

Note

- Set the Slave unit first and then the Master one.
- There can only be ONE Master unit in any Master/Slave configuration.
- Each Slave unit's number Must be unique or the master-slave mode cannot be set.

Operating example for parallel 3 units.

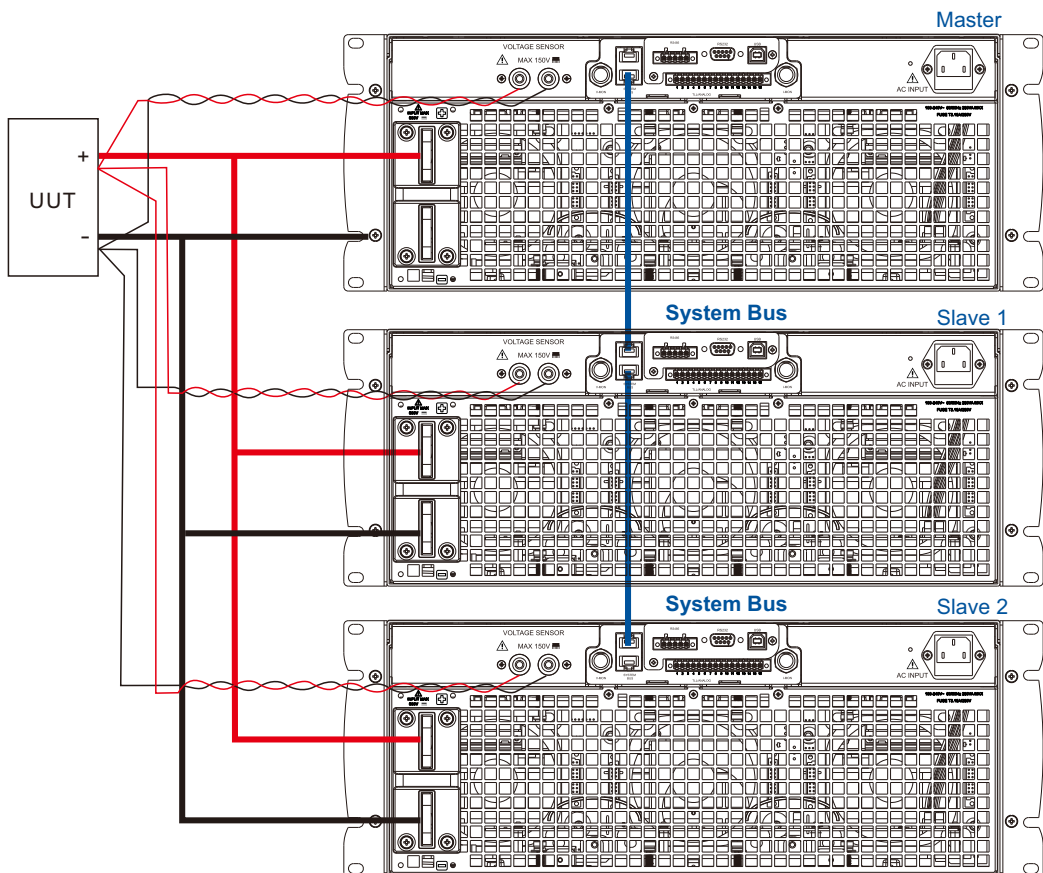

6.1 Parallel Procedure

The parallel connection of 3 units is as follows.

1. Wiring according to the above diagram.

- a. Connect System BUS cables.
- b. Connect UUT.

2. Configure the master-slave mode.

- a. Press the function key to enter into the Paral/Sync.
- b. Select "Parallel" and press [Enter] key to confirm the Parallel setting.
 - Slave mode
 - Master mode

3. Power on procedure in parallel state.

Turn on the SLAVE load first then the MASTER load. The MASTER unit will start to parallel automatically after it is turned on, and resume to the state before power off when the connection is done.

4. Set the Terminal Resistor of the first and last unit to Enable and the rest to Disable.

Press the [Main] key, select configure submenu, then select Paral/Sync submenu, set the Terminal Resistor of the first and last unit to Enable and the rest to Disable.

5. Disable the parallel

If the user want to disable the parallel, turn off the unit, remove the load connection. Press the [Main] key, select configure submenu, then select Paral/Sync submenu, set the Mode to Disable and remove the system bus cable.

7 Installation

7.1 Overview and Dimensions

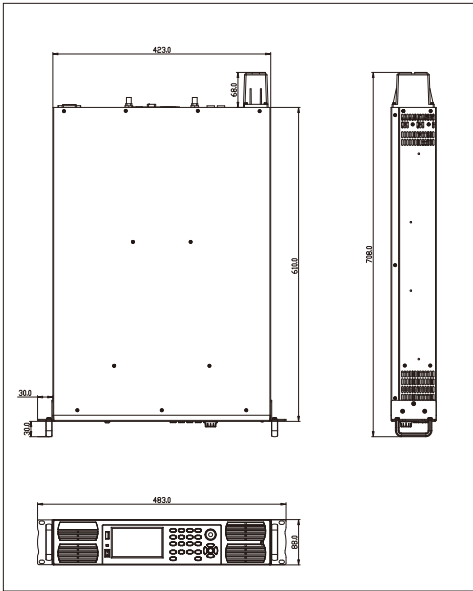

2U Height Models

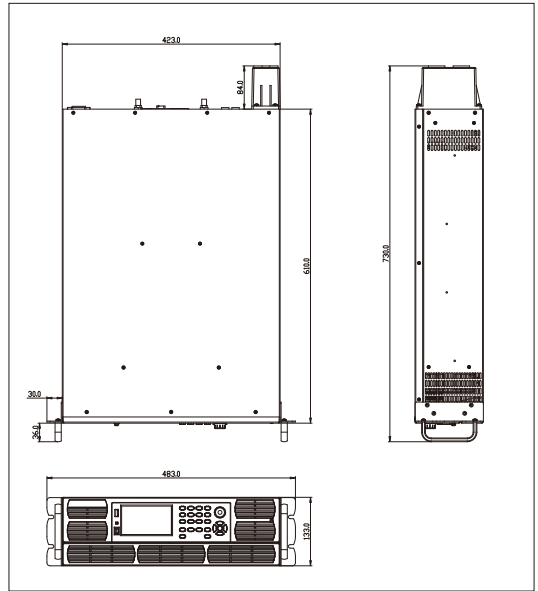

3U Height Models

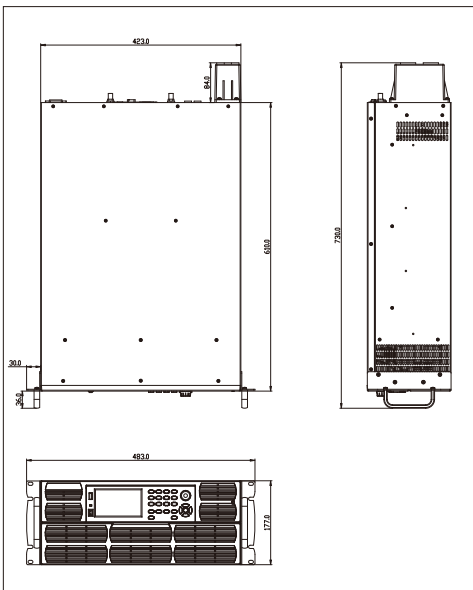

4U Height Models

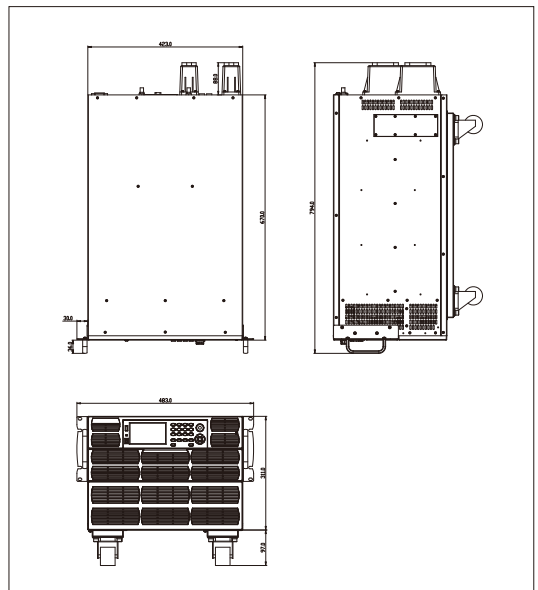

7U Height Models

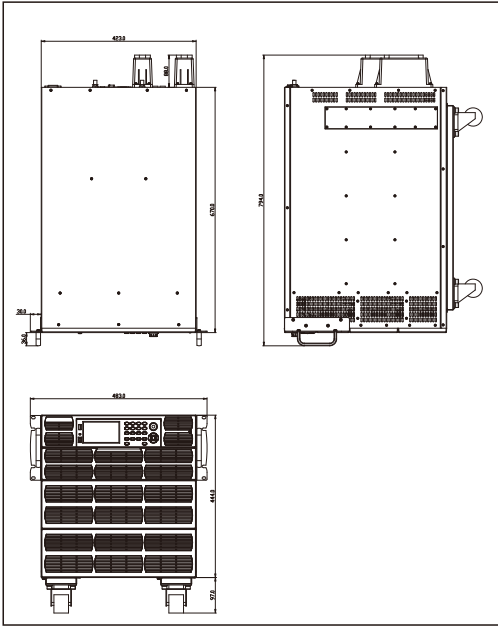

10U Height Models

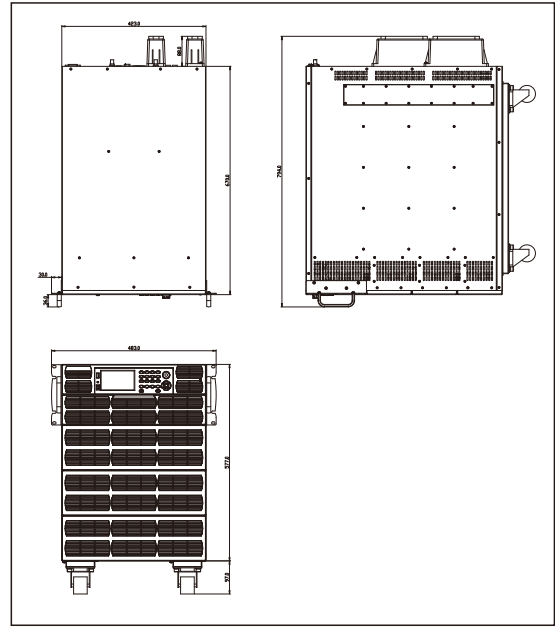

13U Height Models

7.2 AC Input connection

Caution!

Before connecting the power cord, to prevent electric shock and damage to the instrument, please observe the following precautions.

- Before connecting the power cord, make sure the power voltage matches the input voltage range of the instrument.
- Make sure the power switch is off before connecting the power cord.
- To prevent electric shock and fire, please use the power cord provided by APM.
- Be sure to connect the input power cord to the ac distribution box with protective grounding. Do not use the terminal board without protective grounding.
- To prevent electric shock, be sure to take protective grounding. Connect the power cord to a three-pronged socket with a protective earthing terminal.
- Do not use extended power cord without protective grounding wire, otherwise the protection function will fail.
- Use an AC outlet that matches the box's power cord and makes sure it is grounded. Do not use this instrument if appropriate AC power cord is not available.

AC power input level:

This series electronic load supports AC power input range: 100V~240V, 50Hz~60Hz.

7.3 Load Connection

Please make sure that the power is in OFF position before connecting. Loosen the protection cover and pass the cable end through the cable strain relief, tighten the terminal block screws assuring all wires are held tightly.

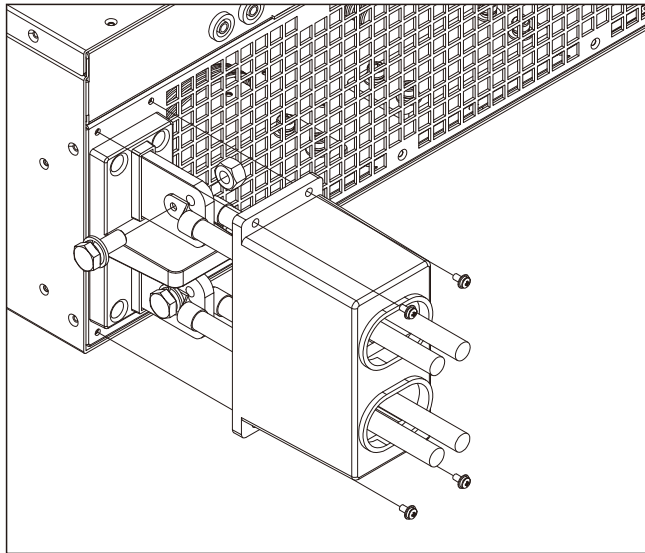

- The wires should be large enough to limit the voltage drop, and as short as possible.

Please refer to the table below to select cable size. Also consider temperature rating of the copper wires and voltage drop to the load:

Rated Current of equipment (A)	Minimum Conduct Sizes		Rated Current of equipment (A)	Minimum Conduct Sizes	
	Nominal Cross-sectional Area (mm ²)	AWG or kcmil		Nominal Cross-sectional Area (mm ²)	AWG or kcmil
13~16	1.5	14	125~160	50	0
16~25	2.5	12	160~190	70	000
25~32	4	10	190~230	95	0000
32~40	6	8	230~260	120	250 kcmil
40~63	10	6	260~300	150	300 kcmil
63~80	16	4	300~340	185	400 kcmil
80~100	25	2	340~400	240	500 kcmil
100~125	35	1	400~460	300	600 kcmil

7.4 Remote Sensing Connections

Under CC, CV, CR or CP mode, if the load consumes large current, a large voltage drop will be detected in connection line between UUT and load terminal. To ensure measurement accuracy, a remote sense measurement is provided at load rear panel to compensate voltage drop lost in wires.

Remote operation: VS+ and VS- are remote input terminals. In order to avoid voltage drop caused by excessively long load input wire, remote test allows direct measurement on input terminal source to improve measurement accuracy.

Wiring according to the figure below. The test wires and Sense wires should be as short as possible, and sense wires should be twisted together.

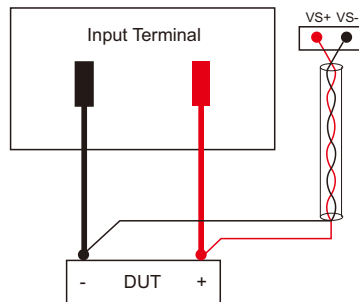

External control

The IO port provides external input and output simulation control and TTL signal. The terminal is a 16P connector.

The external waveform input signal with input range from 0 to 10V to map to a 0 to full scale input range in CC, CV and CR mode. The load also has two independent BNC connectors to monitor the voltage (V-MON) and current (I-MON), a 0V to 10V output signal is mapping to a 0 to full scale input range.

The bandwidth of the input waveform is 20kHz, all the arbitrary waveform with this frequency is supported. When the programming signal frequency or amplitude exceeds the output capacity, it will be automatically limited.

In parallel mode, only the mater unit supports this external control mode.

Logic signals of this interface include running state, short circuit state, sequence step state, trigger signal input and other state signals.

External analog input control voltage

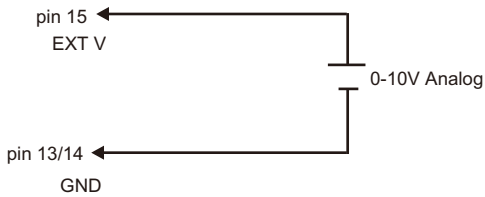

External analog input control current

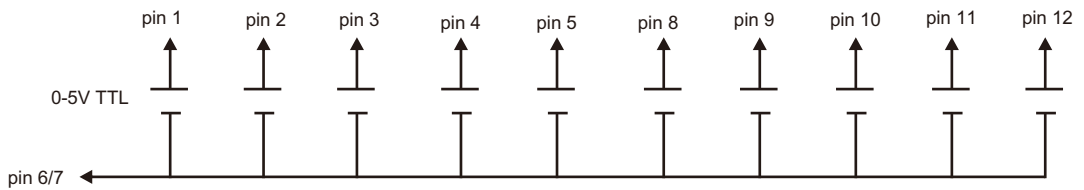
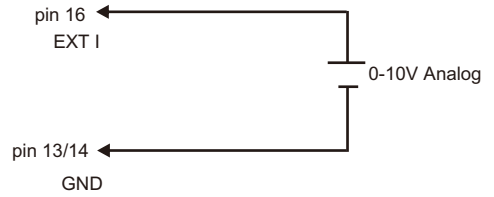

1. Load ON/OFF state

Load ON/OFF state, TTL level.

ON: high level;

OFF: low level;

2. Short ON output signal

Short ON output signal, TTL level.

SHORT: high level;

NORMAL: low level;

3. TTL Out1 / 4. TTL Out2 / 5. TTL Out3

The output range is 0~5VDC, define each pin in the 5.2.7.4 TTL/Analog menu first before using.

NO.	Option	Description
0	Disable	Disabled
1	BattDischarge Finish(H)	Battery discharge test is completed.
2	OCP/OPP Test PASS(H)	OCP/OPP test is completed.
3	Program Finish(H)	Program test is completed.
4	SPEC Test PASS(H)	SPEC test result is NG.
5	OCP, OPP, OTP, OV, REV(H)	OCP, OPP, OTP, OVP or reverse connection alarm.
6	BUS Control(H)	System Bus control is enabled.

6. TTL digital ground

7. TTL digital ground

8. External trigger signal for Program function

TTL level, falling edge, and pulse width are no less than 50us.

9. External trigger signal for Digitizing function

TTL level, falling edge, and pulse width are no less than 50us.

10. TTL In1 / TTL In2

The input range is 0~5VDC, define each pin in the 5.2.7.4 TTL/Analog menu first before using.

NO.	Option	Description
0	Disable	Disabled
1	Load On(H), Load Off(L)	Load on (high level), load off (low level).
2	Remote Inhibit(H)	Inhibit (turn off) the load.

12. I/O control input

13. Analog ground

14. Analog ground

15. The external waveform input signal for voltage (Professional version supported only)

The external waveform input signal with input range from 0 to 10V.

16. The external waveform input signal for current. (Professional version supported only)

The external waveform input signal with input range from 0 to 10V.

8 Troubleshooting

Problem	Troubleshooting and solutions
Inner Communication fault	Ask your agent for help.
Memory fault	Ask your agent for help.
Aux Power fault	Ask your agent for help.
Volt Reverse Fault	Please check and make sure the polarity is correct.
OTP	Please check and make sure the load is installed at well-ventilated and rational-sized place. If the unit still cannot work after checking please ask your agent for help.
FAN fault	Please check and make sure the vent hole is always unblocked. If the unit still cannot work after checking please ask your agent for help.
OV	Please check whether voltage of the power supply is within load rated voltage, or it will bring damage to the load.
OV[Critical]	Please check whether voltage of the power supply is within load rated voltage, or it will bring damage to the load.
OCP	If working in CP mode, clear the failure and check the configuration. Otherwise ask your agent for help.
OCP[Critical]	If working in CP mode, clear the failure and check the configuration. Otherwise ask your agent for help.
OCP[USER]	Please check if customized OCP is necessary and reasonable. If not, please disable this setting.
OPP	Please check if customized OPP is necessary and reasonable. If not, please disable this setting. Otherwise ask your agent for help.
OPP[Critical]	Please check whether the input voltage, setting current and setting range is reasonable. Otherwise ask your agent for help.
OPP[USER]	Please check if customized OCP is necessary and reasonable. If not, please disable this setting.
OPP[Derating]	Please check the working environment temperature, and please see the derating curve for power drop.
Parallel/Sync Fault	Please check and make sure that the terminal resistor has been enabled, and the address settings between slave units and master one are all correct. Otherwise ask your agent for help.
Remote Vsense Fault	Please check if the load is under remote sense input mode.
V-MON/I-MON Fault	Please check and make sure that the configuration on the panel is correct.

9 Recycling and Disposal

Do not discard this device and its accessories as solid waste. Please contact your local government agencies to find out how to properly recycle the product properly.

10 Contact Us

If you have any questions about the High Power DC Load, please contact us. We will be happy to answer any of your questions. Below are our contact details:

APM Technologies

Add: # 7, Link Information Industry Park, Shuilianshan Road, Nancheng, Dongguan, Guangdong, China

Land line: +86-769 22028588

Fax: +86-769 22026771

Website: en.apmtech.cn

E-mail: overseas@apmtech.cn

Appendix A Specifications

MODEL		EL200VDC1200W		
Rated	Voltage	0~200V		
	Current	0~130A		
	Power	0~1200W		
	Min. Operating Voltage	0.18V@13A	0.9V@65A	1.8V@130A
Static Mode				
Constant Current Mode	Range	0~13A	0~65A	0~130A
	Resolution	0.1mA	0.5mA	2mA
	Accuracy	0.05%+0.05%F.S.		
Constant Voltage Mode	Range	0~16V	0~80V	0~200V
	Resolution	0.1mV	0.5mV	2mV
	Accuracy	0.025%+0.025%F.S.		
Constant Power Mode	Range	0~120W	0~600W	0~1200W
	Resolution	10mW	50mW	100mW
	Accuracy	0.2%+0.2%F.S.		
Constant Resistance Mode	Range	30mΩ~300Ω(16V)	120mΩ~1200Ω(80V)	3000mΩ~6000Ω(200V)
	Resolution	30mΩ(16V)	120mΩ(80V)	3000mΩ(200V)
	Accuracy	Vin/Rset*(0.2%)+0.2% I.F.S.		
Dynamic Mode				
CCD/CRD	T1&T2(Pro.)	0.02ms~300s		
	T1&T2(Adv.)	0.05ms~300s		
	Resolution	1μs		
	Accuracy	1μs+100ppm		
	Slew Rate(Pro.)	0.1mA/μs~1.3A/μs	0.5mA/μs~4.55A/μs	2mA/μs~9.1A/μs
	Slew Rate(Adv.)	0.1mA/μs~0.13A/μs	0.5mA/μs~0.65A/μs	2mA/μs~1.3A/μs
	Min. Rise Time(Pro.)	10μs(Typical)		
	Min. Rise Time(Adv.)	50μs(Typical)		
	Resolution	0.1mA/μs	0.5mA/μs	2mA/μs
	Accuracy	5%±10us		
Measurement				
Voltage	Range	0~16V	0~80V	0~200V
	Resolution	0.1mV	0.5mV	1mV
	Accuracy	0.015%+0.015%F.S.		
Current	Range	0~13A	0~65A	0~130A
	Resolution	0.1mA	0.5mA	2mA
	Accuracy	0.04%+0.04%F.S.		
Power	Range	0~120W	0~600W	0~1200W
	Resolution	10mW	50mW	100mW
	Accuracy	0.1%+0.1%F.S.		
Sampling Frequency	500kHz			
Protection				
OVP	17.6V	88V	220V	
OCP	13.26A	66.3A	132.6A	
OPP	123.6W	618W	1236W	
Over Temperature	70~75°C			
Overvoltage Safety Value	110%VF.S.			
Reverse Alarm	Yes			
Alarm Tone	Yes			
Mechanical				
Dimensions(WxHxD)	423.0x88.0x610.0mm			
Package Dimensions(WxHxD)	665.0x333.0x918.0mm			
Unit Weight	20kg			
Shipping Weight	29kg			
AC Input				
Voltage	100~240Vac			
Frequency	50~60Hz			
Power	150VA			
Fuse	2.5A			

MODEL		EL200VDC1800W		
Rated	Voltage	0~200V		
	Current	0~190A		
	Power	0~1800W		
	Min. Operating Voltage	0.18V@19A	0.9V@95A	1.8V@190A
Static Mode				
Constant Current Mode	Range	0~19A	0~95A	0~190A
	Resolution	0.1mA	0.5mA	2mA
	Accuracy	0.05%+0.05%F.S.		
Constant Voltage Mode	Range	0~16V	0~80V	0~200V
	Resolution	0.1mV	0.5mV	2mV
	Accuracy	0.025%+0.025%F.S.		
Constant Power Mode	Range	0~180W	0~900W	0~1800W
	Resolution	10mW	50mW	100mW
	Accuracy	0.2%+0.2%F.S.		
Constant Resistance Mode	Range	20mΩ~200Ω(16V)	80mΩ~800Ω(80V)	2000mΩ~4000Ω(200V)
	Resolution	20mΩ(16V)	80mΩ(80V)	2000mΩ(200V)
	Accuracy	Vin/Rset*(0.2%)+0.2% I.F.S.		
Dynamic Mode				
CCD/CRD	T1&T2(Pro.)	0.02ms~300s		
	T1&T2(Adv.)	0.05ms~300s		
	Resolution	1μs		
	Accuracy	1μs+100ppm		
	Slew Rate(Pro.)	0.1mA/μs~1.9A/μs	0.5mA/μs~6.65A/μs	2mA/μs~13.3A/μs
	Slew Rate(Adv.)	0.1mA/μs~0.19A/μs	0.5mA/μs~0.95A/μs	2mA/μs~1.9A/μs
	Min. Rise Time(Pro.)	10μs(Typical)		
	Min. Rise Time(Adv.)	50μs(Typical)		
	Resolution	0.1mA/μs	0.5mA/μs	2mA/μs
	Accuracy	5%±10us		
Measurement				
Voltage	Range	0~16V	0~80V	0~200V
	Resolution	0.1mV	0.5mV	2mV
	Accuracy	0.015%+0.015%F.S.		
Current	Range	0~19A	0~95A	0~190A
	Resolution	0.1mA	0.5mA	2mA
	Accuracy	0.04%+0.04%F.S.		
Power	Range	0~180W	0~900W	0~1800W
	Resolution	10mW	50mW	100mW
	Accuracy	0.1%+0.1%F.S.		
Sampling Frequency	500kHz			
Protection				
OVP	17.6V	88V	220V	
OCP	19.38A	96.9A	193.8A	
OPP	185.4W	927W	1854W	
Over Temperature	70~75°C			
Overvoltage Safety Value	110%VF.S.			
Reverse Alarm	Yes			
Alarm Tone	Yes			
Mechanical				
Dimensions(WxHxD)	423.0x88.0x610.0mm			
Package Dimensions(WxHxD)	665.0x333.0x918.0mm			
Unit Weight	22kg			
Shipping Weight	31kg			
AC Input				
Voltage	100~240Vac			
Frequency	50~60Hz			
Power	150VA			
Fuse	2.5A			

MODEL		EL200VDC2400W		
Rated	Voltage	0~200V		
	Current	0~260A		
	Power	0~2400W		
	Min. Operating Voltage	0.18V@26A	0.9V@130A	1.8V@260A
Static Mode				
Constant Current Mode	Range	0~26A	0~130A	0~260A
	Resolution	0.5mA	2mA	5mA
	Accuracy	0.05%+0.05%F.S.		
Constant Voltage Mode	Range	0~16V	0~80V	0~200V
	Resolution	0.1mV	0.5mV	2mV
	Accuracy	0.025%+0.025%F.S.		
Constant Power Mode	Range	0~240W	0~1200W	0~2400W
	Resolution	10mW	50mW	100mW
	Accuracy	0.2%+0.2%F.S.		
Constant Resistance Mode	Range	15mΩ~150Ω(16V)	60mΩ~600Ω(80V)	1500mΩ~3000Ω(200V)
	Resolution	15mΩ(16V)	60mΩ(80V)	1500mΩ(200V)
	Accuracy	Vin/Rset*(0.2%)+0.2% I.F.S.		
Dynamic Mode				
CCD/CRD	T1&T2(Pro.)	0.02ms~300s		
	T1&T2(Adv.)	0.05ms~300s		
	Resolution	1μs		
	Accuracy	1μs+100ppm		
	Slew Rate(Pro.)	0.5mA/μs~2.6A/μs	2mA/μs~9.1A/μs	5mA/μs~18.2A/μs
	Slew Rate(Adv.)	0.5mA/μs~0.26A/μs	2mA/μs~1.3A/μs	5mA/μs~2.6A/μs
	Min. Rise Time(Pro.)	10μs(Typical)		
	Min. Rise Time(Adv.)	50μs(Typical)		
	Resolution	0.5mA/μs	2mA/μs	5mA/μs
	Accuracy	5%±10us		
Measurement				
Voltage	Range	0~16V	0~80V	0~200V
	Resolution	0.1mV	0.5mV	2mV
	Accuracy	0.015%+0.015%F.S.		
Current	Range	0~26A	0~130A	0~260A
	Resolution	0.5mA	2mA	5mA
	Accuracy	0.04%+0.04%F.S.		
Power	Range	0~240W	0~1200W	0~2400W
	Resolution	10mW	50mW	100mW
	Accuracy	0.1%+0.1%F.S.		
Sampling Frequency	500kHz			
Protection				
OVP	17.6V	88V	220V	
OCP	26.52A	132.6A	265.2A	
OPP	247.2W	1236W	2472W	
Over Temperature	70~75°C			
Overvoltage Safety Value	110%V.F.S.			
Reverse Alarm	Yes			
Alarm Tone	Yes			
Mechanical				
Dimensions(WxHxD)	423.0x88.0x610.0mm			
Package Dimensions(WxHxD)	665.0x333.0x918.0mm			
Unit Weight	24kg			
Shipping Weight	33kg			
AC Input				
Voltage	100~240Vac			
Frequency	50~60Hz			
Power	180VA			
Fuse	2.5A			

MODEL		EL200VDC3000W		
Rated	Voltage	0~200V		
	Current	0~320A		
	Power	0~3000W		
	Min. Operating Voltage	0.18V@32A	0.9V@160A	1.8V@280A
Static Mode				
Constant Current Mode	Range	0~32A	0~160A	0~320A
	Resolution	0.5mA	2mA	5mA
	Accuracy	0.05%+0.05%F.S.		
Constant Voltage Mode	Range	0~16V	0~80V	0~200V
	Resolution	0.1mV	0.5mV	2mV
	Accuracy	0.025%+0.025%F.S.		
Constant Power Mode	Range	0~300W	0~1500W	0~3000W
	Resolution	10mW	50mW	100mW
	Accuracy	0.2%+0.2%F.S.		
Constant Resistance Mode	Range	10mΩ~100Ω(16V)	40mΩ~400Ω(80V)	1000mΩ~2000Ω(200V)
	Resolution	10mΩ(16V)	40mΩ(80V)	1000mΩ(200V)
	Accuracy	Vin/Rset*(0.2%)+0.2% I.F.S.		
Dynamic Mode				
CCD/CRD	T1&T2(Pro.)	0.02ms~300s		
	T1&T2(Adv.)	0.05ms~300s		
	Resolution	1μs		
	Accuracy	1μs+100ppm		
	Slew Rate(Pro.)	0.5mA/μs~3.2A/μs	2mA/μs~11.2A/μs	5mA/μs~22.4A/μs
	Slew Rate(Adv.)	0.5mA/μs~0.32A/μs	2mA/μs~1.6A/μs	5mA/μs~3.2A/μs
	Min. Rise Time(Pro.)	10μs(Typical)		
	Min. Rise Time(Adv.)	50μs(Typical)		
	Resolution	0.5mA/μs	2mA/μs	5mA/μs
	Accuracy	5%±10us		
Measurement				
Voltage	Range	0~16V	0~80V	0~200V
	Resolution	0.1mV	0.5mV	2mV
	Accuracy	0.015%+0.015%F.S.		
Current	Range	0~32A	0~160A	0~320A
	Resolution	0.5mA	2mA	5mA
	Accuracy	0.04%+0.04%F.S.		
Power	Range	0~300W	0~1500W	0~3000W
	Resolution	10mW	50mW	100mW
	Accuracy	0.1%+0.1%F.S.		
Sampling Frequency	500kHz			
Protection				
OVP	17.6V	88V	220V	
OCP	32.64A	163.2A	326.4A	
OPP	309W	1545W	3090W	
Over Temperature	70~75°C			
Overvoltage Safety Value	110%V.F.S.			
Reverse Alarm	Yes			
Alarm Tone	Yes			
Mechanical				
Dimensions(WxHxD)	423.0x88.0x610.0mm			
Package Dimensions(WxHxD)	665.0x333.0x918.0mm			
Unit Weight	26kg			
Shipping Weight	35kg			
AC Input				
Voltage	100~240Vac			
Frequency	50~60Hz			
Power	180VA			
Fuse	2.5A			

MODEL		EL200VDC3400W		
Rated	Voltage	0~200V		
	Current	0~370A		
	Power	0~3400W		
	Min. Operating Voltage	0.18V@37A	0.9V@185A	1.8V@370A
Static Mode				
Constant Current Mode	Range	0~37A	0~185A	0~370A
	Resolution	0.5mA	2mA	5mA
	Accuracy	0.05%+0.05%F.S.		
Constant Voltage Mode	Range	0~16V	0~80V	0~200V
	Resolution	0.1mV	0.5mV	2mV
	Accuracy	0.025%+0.025%F.S.		
Constant Power Mode	Range	0~340W	0~1700W	0~3400W
	Resolution	10mW	50mW	100mW
	Accuracy	0.2%+0.2%F.S.		
Constant Resistance Mode	Range	10mΩ~100Ω(16V)	40mΩ~400Ω(80V)	1000mΩ~2000Ω(200V)
	Resolution	10mΩ(16V)	40mΩ(80V)	1000mΩ(200V)
	Accuracy	Vin/Rset*(0.2%)+0.2% I.F.S.		
Dynamic Mode				
CCD/CRD	T1&T2(Pro.)	0.02ms~300s		
	T1&T2(Adv.)	0.05ms~300s		
	Resolution	1μs		
	Accuracy	1μs+100ppm		
	Slew Rate(Pro.)	0.5mA/μs~3.7A/μs	2mA/μs~12.95A/μs	5mA/μs~25.9A/μs
	Slew Rate(Adv.)	0.5mA/μs~0.37A/μs	2mA/μs~1.85A/μs	5mA/μs~3.7A/μs
	Min. Rise Time(Pro.)	10μs(Typical)		
	Min. Rise Time(Adv.)	50μs(Typical)		
	Resolution	0.5mA/μs	2mA/μs	5mA/μs
	Accuracy	5%±10us		
Measurement				
Voltage	Range	0~16V	0~80V	0~200V
	Resolution	0.1mV	0.5mV	2mAV
	Accuracy	0.015%+0.015%F.S.		
Current	Range	0~37A	0~185A	0~370A
	Resolution	0.5mA	2mA	5mA
	Accuracy	0.04%+0.04%F.S.		
Power	Range	0~340W	0~1700W	0~3400W
	Resolution	10mW	50mW	100mW
	Accuracy	0.1%+0.1%F.S.		
Sampling Frequency	500kHz			
Protection				
OVP	17.6V	88V	220V	
OCP	37.74A	188.7A	377.4A	
OPP	350.2W	1751W	3502W	
Over Temperature	70~75°C			
Overvoltage Safety Value	110%V.F.S.			
Reverse Alarm	Yes			
Alarm Tone	Yes			
Mechanical				
Dimensions(WxHxD)	423.0x133.0x610.0mm			
Package Dimensions(WxHxD)	665.0x348.0x918.0mm			
Unit Weight	27kg			
Shipping Weight	36kg			
AC Input				
Voltage	100~240Vac			
Frequency	50~60Hz			
Power	200VA			
Fuse	2.5A			

MODEL		EL200VDC4400W		
Rated	Voltage	0~200V		
	Current	0~480A		
	Power	0~4400W		
	Min. Operating Voltage	0.18V@48A	0.9V@240A	1.8V@480A
Static Mode				
Constant Current Mode	Range	0~48A	0~240A	0~480A
	Resolution	0.5mA	2mA	5mA
	Accuracy	0.05%+0.05%F.S.		
Constant Voltage Mode	Range	0~16V	0~80V	0~200V
	Resolution	0.1mV	0.5mV	2mV
	Accuracy	0.025%+0.025%F.S.		
Constant Power Mode	Range	0~440W	0~2200W	0~4400W
	Resolution	10mW	50mW	100mW
	Accuracy	0.2%+0.2%F.S.		
Constant Resistance Mode	Range	7.5mΩ~75Ω(16V)	30mΩ~300Ω(80V)	750mΩ~1500Ω(200V)
	Resolution	7.5mΩ(16V)	30mΩ(80V)	750mΩ(200V)
	Accuracy	Vin/Rset*(0.2%)+0.2% I.F.S.		
Dynamic Mode				
CCD/CRD	T1&T2(Pro.)	0.02ms~300s		
	T1&T2(Adv.)	0.05ms~300s		
	Resolution	1μs		
	Accuracy	1μs+100ppm		
	Slew Rate(Pro.)	0.5mA/μs~4.8A/μs	2mA/μs~16.8A/μs	5mA/μs~33.6A/μs
	Slew Rate(Adv.)	0.5mA/μs~0.48A/μs	2mA/μs~2.4A/μs	5mA/μs~4.8A/μs
	Min. Rise Time(Pro.)	10μs(Typical)		
	Min. Rise Time(Adv.)	50μs(Typical)		
	Resolution	0.5mA/μs	2mA/μs	5mA/μs
	Accuracy	5%±10us		
Measurement				
Voltage	Range	0~16V	0~80V	0~200V
	Resolution	0.1mAV	0.5mV	2mV
	Accuracy	0.015%+0.015%F.S.		
Current	Range	0~48A	0~240A	0~480A
	Resolution	0.5mA	2mA	5mA
	Accuracy	0.04%+0.04%F.S.		
Power	Range	0~440W	0~2200W	0~4400W
	Resolution	10mW	50mW	100mW
	Accuracy	0.1%+0.1%F.S.		
Sampling Frequency	500kHz			
Protection				
OVP	17.6V	88V	220V	
OCP	48.96A	244.8A	489.6A	
OPP	453.2W	2266W	4532W	
Over Temperature	70~75°C			
Overvoltage Safety Value	110%VF.S.			
Reverse Alarm	Yes			
Alarm Tone	Yes			
Mechanical				
Dimensions(WxHxD)	423.0x133.0x610.0mm			
Package Dimensions(WxHxD)	665.0x348.0x918.0mm			
Unit Weight	28.5kg			
Shipping Weight	37.3kg			
AC Input				
Voltage	100~240Vac			
Frequency	50~60Hz			
Power	200VA			
Fuse	2.5A			

MODEL		EL200VDC5600W		
Rated	Voltage	0~200V		
	Current	0~610A		
	Power	0~5600W		
	Min. Operating Voltage	0.18V@61A	0.9V@305A	1.8V@610A
Static Mode				
Constant Current Mode	Range	0~61A	0~305A	0~610A
	Resolution	0.5mA	2mA	5mA
	Accuracy	0.05%+0.05%F.S.		
Constant Voltage Mode	Range	0~16V	0~80V	0~200V
	Resolution	0.1mV	0.5mV	2mV
	Accuracy	0.025%+0.025%F.S.		
Constant Power Mode	Range	0~560W	0~2800W	0~5600W
	Resolution	10mW	50mW	100mW
	Accuracy	0.2%+0.2%F.S.		
Constant Resistance Mode	Range	7.5mΩ~75Ω(16V)	30mΩ~300Ω(80V)	750mΩ~1500Ω(200V)
	Resolution	7.5mΩ(16V)	30mΩ(80V)	750mΩ(200V)
	Accuracy	Vin/Rset*(0.2%)+0.2% I.F.S.		
Dynamic Mode				
CCD/CRD	T1&T2(Pro.)	0.02ms~300s		
	T1&T2(Adv.)	0.05ms~300s		
	Resolution	1μs		
	Accuracy	1μs+100ppm		
	Slew Rate(Pro.)	0.5mA/μs~6.1A/μs	2mA/μs~21.35A/μs	5mA/μs~42.7A/μs
	Slew Rate(Adv.)	0.5mA/μs~0.61A/μs	2mA/μs~3.05A/μs	5mA/μs~6.1A/μs
	Min. Rise Time(Pro.)	10μs(Typical)		
	Min. Rise Time(Adv.)	50μs(Typical)		
	Resolution	0.5mA/μs	2mA/μs	5mA/μs
	Accuracy	5%±10us		
Measurement				
Voltage	Range	0~16V	0~80V	0~200V
	Resolution	0.1mV	0.5mV	2mV
	Accuracy	0.015%+0.015%F.S.		
Current	Range	0~61A	0~305A	0~610A
	Resolution	0.5mA	2mA	5mA
	Accuracy	0.04%+0.04%F.S.		
Power	Range	0~560W	0~2800W	0~5600W
	Resolution	10mW	50mW	100mW
	Accuracy	0.1%+0.1%F.S.		
Sampling Frequency	500kHz			
Protection				
OVP	17.6V	88V	220V	
OCP	62.22A	311.1A	622.2A	
OPP	576.8W	2884W	5768W	
Over Temperature	70~75°C			
Overvoltage Safety Value	110%VF.S.			
Reverse Alarm	Yes			
Alarm Tone	Yes			
Mechanical				
Dimensions(WxHxD)	423.0x133.0x610.0mm			
Package Dimensions(WxHxD)	665.0x348.0x918.0mm			
Unit Weight	32.5kg			
Shipping Weight	41.3kg			
AC Input				
Voltage	100~240Vac			
Frequency	50~60Hz			
Power	200VA			
Fuse	2.5A			

MODEL		EL200VDC6600W		
Rated	Voltage	0~200V		
	Current	0~720A		
	Power	0~6600W		
	Min. Operating Voltage	0.18V@72A	0.9V@360A	1.8V@720A
Static Mode				
Constant Current Mode	Range	0~72A	0~360A	0~720A
	Resolution	0.5mA	2mA	5mA
	Accuracy	0.05%+0.05%F.S.		
Constant Voltage Mode	Range	0~16V	0~80V	0~200V
	Resolution	0.1mV	0.5mV	2mV
	Accuracy	0.025%+0.025%F.S.		
Constant Power Mode	Range	0~660W	0~3300W	0~6600W
	Resolution	10mW	50mW	100mW
	Accuracy	0.2%+0.2%F.S.		
Constant Resistance Mode	Range	5mΩ~50Ω(16V)	20mΩ~200Ω(80V)	500mΩ~1000Ω(200V)
	Resolution	5mΩ(16V)	20mΩ(80V)	500mΩ(200V)
	Accuracy	Vin/Rset*(0.2%)+0.2% I.F.S.		
Dynamic Mode				
CCD/CRD	T1&T2(Pro.)	0.02ms~300s		
	T1&T2(Adv.)	0.05ms~300s		
	Resolution	1μs		
	Accuracy	1μs+100ppm		
	Slew Rate(Pro.)	0.5mA/μs~7.2A/μs	2mA/μs~25.2A/μs	5mA/μs~50.4A/μs
	Slew Rate(Adv.)	0.5mA/μs~0.72A/μs	2mA/μs~3.6A/μs	5mA/μs~7.2A/μs
	Min. Rise Time(Pro.)	10μs(Typical)		
	Min. Rise Time(Adv.)	50μs(Typical)		
	Resolution	0.5mA/μs	2mA/μs	5mA/μs
	Accuracy	5%±10us		
Measurement				
Voltage	Range	0~16V	0~80V	0~200V
	Resolution	0.1mV	0.5mV	2mV
	Accuracy	0.015%+0.015%F.S.		
Current	Range	0~72A	0~360A	0~720A
	Resolution	0.5mA	2mA	5mA
	Accuracy	0.04%+0.04%F.S.		
Power	Range	0~660W	0~3300W	0~6600W
	Resolution	10mW	50mW	100mW
	Accuracy	0.1%+0.1%F.S.		
Sampling Frequency	500kHz			
Protection				
OVP	17.6V	88V	220V	
OCP	73.44A	367.2A	734.4A	
OPP	679.8W	3399W	6798W	
Over Temperature	70~75°C			
Overvoltage Safety Value	110%V.F.S.			
Reverse Alarm	Yes			
Alarm Tone	Yes			
Mechanical				
Dimensions(WxHxD)	423.0x177.0x610.0mm			
Package Dimensions(WxHxD)	665.0x392.0x918.0mm			
Unit Weight	38kg			
Shipping Weight	47kg			
AC Input				
Voltage	100~240Vac			
Frequency	50~60Hz			
Power	250VA			
Fuse	3.15A			

MODEL		EL200VDC8800W		
Rated	Voltage	0~200V		
	Current	0~960A		
	Power	0~8800W		
	Min. Operating Voltage	0.18V@96A	0.9V@480A	1.8V@960A
Static Mode				
Constant Current Mode	Range	0~96A	0~480A	0~960A
	Resolution	1mA	5mA	10mA
	Accuracy	0.05%+0.05%F.S.		
Constant Voltage Mode	Range	0~16V	0~80V	0~200V
	Resolution	0.1mV	0.5mV	2mV
	Accuracy	0.025%+0.025%F.S.		
Constant Power Mode	Range	0~880W	0~4400W	0~8800W
	Resolution	20mW	100mW	200mW
	Accuracy	0.2%+0.2%F.S.		
Constant Resistance Mode	Range	4mΩ~40Ω(16V)	15mΩ~150Ω(80V)	375mΩ~750Ω(200V)
	Resolution	4mΩ(16V)	15mΩ(80V)	375mΩ(200V)
	Accuracy	Vin/Rset*(0.2%)+0.2% I.F.S.		
Dynamic Mode				
CCD/CRD	T1&T2(Pro.)	0.02ms~300s		
	T1&T2(Adv.)	0.05ms~300s		
	Resolution	1μs		
	Accuracy	1μs+100ppm		
	Slew Rate(Pro.)	0.5mA/μs~9.6A/μs	2mA/μs~28.8A/μs	5mA/μs~57.6A/μs
	Slew Rate(Adv.)	0.5mA/μs~0.96A/μs	2mA/μs~4.8A/μs	5mA/μs~9.6A/μs
	Min. Rise Time(Pro.)	10μs(Typical)		
	Min. Rise Time(Adv.)	50μs(Typical)		
	Resolution	1mA/μs	5mA/μs	10mA/μs
	Accuracy	5%±10us		
Measurement				
Voltage	Range	0~16V	0~80V	0~200V
	Resolution	0.1mV	0.5mV	2mV
	Accuracy	0.015%+0.015%F.S.		
Current	Range	0~96A	0~480A	0~960A
	Resolution	1mA	5mA	10mA
	Accuracy	0.04%+0.04%F.S.		
Power	Range	0~880W	0~4400W	0~8800W
	Resolution	20mW	100mW	200mW
	Accuracy	0.1%+0.1%F.S.		
Sampling Frequency	500kHz			
Protection				
OVP	17.6V	88V	220V	
OCP	97.92A	489.6A	979.2A	
OPP	906.4W	4532W	9064W	
Over Temperature	70~75°C			
Overvoltage Safety Value	110%VF.S.			
Reverse Alarm	Yes			
Alarm Tone	Yes			
Mechanical				
Dimensions(WxHxD)	423.0x311.0x670.0mm			
Package Dimensions(WxHxD)	541.0x591.0x891.0mm			
Unit Weight	61.5kg			
Shipping Weight	81.5kg			
AC Input				
Voltage	100~240Vac			
Frequency	50~60Hz			
Power	450VA			
Fuse	5A			

MODEL		EL200VDC11000W		
Rated	Voltage	0~200V		
	Current	0~1200A		
	Power	0~11000W		
	Min. Operating Voltage	0.18V@120A	0.9V@600A	1.8V@1200A
Static Mode				
Constant Current Mode	Range	0~120A	0~600A	0~1200A
	Resolution	1mA	5mA	10mA
	Accuracy	0.05%+0.05%F.S.		
Constant Voltage Mode	Range	0~16V	0~80V	0~200V
	Resolution	0.1mV	0.5mV	2mV
	Accuracy	0.025%+0.025%F.S.		
Constant Power Mode	Range	0~1100W	0~5500W	0~11000W
	Resolution	20mW	100mW	200mW
	Accuracy	0.2%+0.2%F.S.		
Constant Resistance Mode	Range	3mΩ~30Ω(16V)	12mΩ~120Ω(80V)	300mΩ~600Ω(200V)
	Resolution	3mΩ(16V)	12mΩ(80V)	300mΩ(200V)
	Accuracy	Vin/Rset*(0.2%)+0.2% I.F.S.		
Dynamic Mode				
CCD/CRD	T1&T2(Pro.)	0.02ms~300s		
	T1&T2(Adv.)	0.05ms~300s		
	Resolution	1μs		
	Accuracy	1μs+100ppm		
	Slew Rate(Pro.)	1mA/μs~12A/μs	5mA/μs~30A/μs	10mA/μs~60A/μs
	Slew Rate(Adv.)	1mA/μs~1.2A/μs	5mA/μs~6A/μs	10mA/μs~12A/μs
	Min. Rise Time(Pro.)	10μs(Typical)		
	Min. Rise Time(Adv.)	50μs(Typical)		
	Resolution	1mA/μs	5mA/μs	10mA/μs
	Accuracy	5%±10us		
Measurement				
Voltage	Range	0~16V	0~80V	0~200V
	Resolution	0.1mV	0.5mV	2mV
	Accuracy	0.015%+0.015%F.S.		
Current	Range	0~120A	0~600A	0~1200A
	Resolution	1mA	5mA	10mA
	Accuracy	0.04%+0.04%F.S.		
Power	Range	0~1100W	0~5500W	0~11000W
	Resolution	20mW	100mW	200mW
	Accuracy	0.1%+0.1%F.S.		
Sampling Frequency	500kHz			
Protection				
OVP	17.6V	88V	220V	
OCP	122.4A	612A	1224A	
OPP	1133W	5665W	11330W	
Over Temperature	70~75°C			
Overvoltage Safety Value	110%V.F.S.			
Reverse Alarm	Yes			
Alarm Tone	Yes			
Mechanical				
Dimensions(WxHxD)	423.0x311.0x670.0mm			
Package Dimensions(WxHxD)	541.0x591.0x891.0mm			
Unit Weight	67kg			
Shipping Weight	87kg			
AC Input				
Voltage	100~240Vac			
Frequency	50~60Hz			
Power	450VA			
Fuse	5A			

MODEL		EL200VDC13200W		
Rated	Voltage	0~200V		
	Current	0~1440A		
	Power	0~13200W		
	Min. Operating Voltage	0.18V@144A	0.9V@720A	1.8V@1440A
Static Mode				
Constant Current Mode	Range	0~144A	0~720A	0~1440A
	Resolution	1mA	5mA	8mA
	Accuracy	0.05%+0.05%F.S.		
Constant Voltage Mode	Range	0~16V	0~80V	0~200V
	Resolution	0.1mV	0.5mV	2mV
	Accuracy	0.025%+0.025%F.S.		
Constant Power Mode	Range	0~1320W	0~6600W	0~13200W
	Resolution	40mW	200mW	400mW
	Accuracy	0.2%+0.2%F.S.		
Constant Resistance Mode	Range	2.5mΩ~25Ω(16V)	10mΩ~100Ω(80V)	250mΩ~500Ω(200V)
	Resolution	2.5mΩ(16V)	10mΩ(80V)	250mΩ(200V)
	Accuracy	Vin/Rset*(0.2%)+0.2% I.F.S.		
Dynamic Mode				
CCD/CRD	T1&T2(Pro.)	0.02ms~300s		
	T1&T2(Adv.)	0.05ms~300s		
	Resolution	1μs		
	Accuracy	1μs+100ppm		
	Slew Rate(Pro.)	1mA/μs~14.4A/μs	5mA/μs~32.4A/μs	10mA/μs~64.8A/μs
	Slew Rate(Adv.)	1mA/μs~1.44A/μs	5mA/μs~7.2A/μs	10mA/μs~14.4A/μs
	Min. Rise Time(Pro.)	10μs(Typical)		
	Min. Rise Time(Adv.)	50μs(Typical)		
	Resolution	1mA/μs	5mA/μs	10mA/μs
	Accuracy	5%±10us		
Measurement				
Voltage	Range	0~16V	0~80V	0~200V
	Resolution	0.1mV	0.5mV	2mV
	Accuracy	0.015%+0.015%F.S.		
Current	Range	0~144A	0~720A	0~1440A
	Resolution	1mA	5mA	10mA
	Accuracy	0.04%+0.04%F.S.		
Power	Range	0~1320W	0~6600W	0~13200W
	Resolution	40mW	200mW	400mW
	Accuracy	0.1%+0.1%F.S.		
Sampling Frequency	500kHz			
Protection				
OVP	17.6V	88V	220V	
OCP	146.88A	734.4A	1468.8A	
OPP	1359.6W	6798W	13596W	
Over Temperature	70~75°C			
Overvoltage Safety Value	110%VF.S.			
Reverse Alarm	Yes			
Alarm Tone	Yes			
Mechanical				
Dimensions(WxHxD)	423.0x311.0x670.0mm			
Package Dimensions(WxHxD)	541.0x591.0x891.0mm			
Unit Weight	72.5kg			
Shipping Weight	92.5kg			
AC Input				
Voltage	100~240Vac			
Frequency	50~60Hz			
Power	450VA			
Fuse	5A			

MODEL		EL200VDC15400W		
Rated	Voltage	0~200V		
	Current	0~1680A		
	Power	0~15400W		
	Min. Operating Voltage	0.18V@168A	0.9V@840A	1.8V@1680A
Static Mode				
Constant Current Mode	Range	0~168A	0~840A	0~1680A
	Resolution	2mA	10mA	20mA
	Accuracy	0.05%+0.05%F.S.		
Constant Voltage Mode	Range	0~16V	0~80V	0~200V
	Resolution	0.1mV	0.5mV	2mV
	Accuracy	0.025%+0.025%F.S.		
Constant Power Mode	Range	0~1540W	0~7700W	0~15400W
	Resolution	40mW	200mW	400mW
	Accuracy	0.2%+0.2%F.S.		
Constant Resistance Mode	Range	2.5mΩ~25Ω(16V)	10mΩ~100Ω(80V)	250mΩ~500Ω(200V)
	Resolution	2.5mΩ(16V)	10mΩ(80V)	250mΩ(200V)
	Accuracy	Vin/Rset*(0.2%)+0.2% I.F.S.		
Dynamic Mode				
CCD/CRD	T1&T2(Pro.)	0.02ms~300s		
	T1&T2(Adv.)	0.05ms~300s		
	Resolution	1μs		
	Accuracy	1μs+100ppm		
	Slew Rate(Pro.)	2mA/μs~16.8A/μs	10mA/μs~33.6A/μs	20mA/μs~67.2A/μs
	Slew Rate(Adv.)	2mA/μs~1.68A/μs	10mA/μs~8.4A/μs	20mA/μs~16.8A/μs
	Min. Rise Time(Pro.)	10μs(Typical)		
	Min. Rise Time(Adv.)	50μs(Typical)		
	Resolution	2mA/μs	10mA/μs	20mA/μs
	Accuracy	5%±10us		
Measurement				
Voltage	Range	0~16V	0~80V	0~200V
	Resolution	0.1mV	0.5mV	2mV
	Accuracy	0.015%+0.015%F.S.		
Current	Range	0~168A	0~840A	0~1680A
	Resolution	2mA	10mA	20mA
	Accuracy	0.04%+0.04%F.S.		
Power	Range	0~1540W	0~7700W	0~15400W
	Resolution	40mW	200mW	400mW
	Accuracy	0.1%+0.1%F.S.		
Sampling Frequency	500kHz			
Protection				
OVP	17.6V	88V	220V	
OCP	171.36A	856.8A	1713.6A	
OPP	1586.2W	7931W	15862W	
Over Temperature	70~75°C			
Overvoltage Safety Value	110%V.F.S.			
Reverse Alarm	Yes			
Alarm Tone	Yes			
Mechanical				
Dimensions(WxHxD)	423.0x444.0x670.0mm			
Package Dimensions(WxHxD)	544.0x741.0x891.0mm			
Unit Weight	94.5kg			
Shipping Weight	116.5kg			
AC Input				
Voltage	100~240Vac			
Frequency	50~60Hz			
Power	700VA			
Fuse	10A			

MODEL		EL200VDC17600W		
Rated	Voltage	0~200V		
	Current	0~1920A		
	Power	0~17600W		
	Min. Operating Voltage	0.18V@192A	0.9V@960A	1.8V@1920A
Static Mode				
Constant Current Mode	Range	0~192A	0~960A	0~1920A
	Resolution	2mA	10mA	20mA
	Accuracy	0.05%+0.05%F.S.		
Constant Voltage Mode	Range	0~16V	0~80V	0~200V
	Resolution	0.1mV	0.5mV	2mV
	Accuracy	0.025%+0.025%F.S.		
Constant Power Mode	Range	0~1760W	0~8800W	0~17600W
	Resolution	100mW	500mW	1000mW
	Accuracy	0.2%+0.2%F.S.		
Constant Resistance Mode	Range	2mΩ~20Ω(16V)	7.5mΩ~75Ω(80V)	200mΩ~400Ω(200V)
	Resolution	2mΩ(16V)	7.5mΩ(80V)	200mΩ(200V)
	Accuracy	Vin/Rset*(0.2%)+0.2% I.F.S.		
Dynamic Mode				
CCD/CRD	T1&T2(Pro.)	0.02ms~300s		
	T1&T2(Adv.)	0.05ms~300s		
	Resolution	1μs		
	Accuracy	1μs+100ppm		
	Slew Rate(Pro.)	2mA/μs~19.2A/μs	10mA/μs~38.4A/μs	20mA/μs~76.8A/μs
	Slew Rate(Adv.)	2mA/μs~1.92A/μs	10mA/μs~9.6A/μs	20mA/μs~19.2A/μs
	Min. Rise Time(Pro.)	10μs(Typical)		
	Min. Rise Time(Adv.)	50μs(Typical)		
	Resolution	2mA/μs	10mA/μs	20mA/μs
	Accuracy	5%±10us		
Measurement				
Voltage	Range	0~16V	0~80V	0~200V
	Resolution	0.1mV	0.5mV	2mV
	Accuracy	0.015%+0.015%F.S.		
Current	Range	0~192A	0~960A	0~1920A
	Resolution	2mA	10mA	20mA
	Accuracy	0.04%+0.04%F.S.		
Power	Range	0~1760W	0~8800W	0~17600W
	Resolution	100mW	500mW	1000mW
	Accuracy	0.1%+0.1%F.S.		
Sampling Frequency	500kHz			
Protection				
OVP	17.6V	88V	220V	
OCP	195.84A	979.2A	1958.4A	
OPP	1812.8W	9064W	18128W	
Over Temperature	70~75°C			
Overvoltage Safety Value	110%VF.S.			
Reverse Alarm	Yes			
Alarm Tone	Yes			
Mechanical				
Dimensions(WxHxD)	423.0x444.0x670.0mm			
Package Dimensions(WxHxD)	544.0x741.0x891.0mm			
Unit Weight	100kg			
Shipping Weight	122kg			
AC Input				
Voltage	100~240Vac			
Frequency	50~60Hz			
Power	700VA			
Fuse	8A			

MODEL		EL200VDC19800W		
Rated	Voltage	0~200V		
	Current	0~2160A		
	Power	0~19800W		
	Min. Operating Voltage	0.18V@216A	0.9V@1080A	1.8V@2160A
Static Mode				
Constant Current Mode	Range	0~216A	0~1080A	0~2160A
	Resolution	2mA	10mA	20mA
	Accuracy	0.05%+0.05%F.S.		
Constant Voltage Mode	Range	0~16V	0~80V	0~200V
	Resolution	0.1mV	0.5mV	2mV
	Accuracy	0.025%+0.025%F.S.		
Constant Power Mode	Range	0~1980W	0~9900W	0~19800W
	Resolution	100mW	500mW	1000mW
	Accuracy	0.2%+0.2%F.S.		
Constant Resistance Mode	Range	1.7mΩ~16.7Ω(16V)	6.7mΩ~66.7Ω(80V)	166.7mΩ~333Ω(200V)
	Resolution	1.7mΩ(16V)	6.7mΩ(80V)	166.7mΩ(200V)
	Accuracy	Vin/Rset*(0.2%)+0.2% I.F.S.		
Dynamic Mode				
CCD/CRD	T1&T2(Pro.)	0.02ms~300s		
	T1&T2(Adv.)	0.05ms~300s		
	Resolution	1μs		
	Accuracy	1μs+100ppm		
	Slew Rate(Pro.)	2mA/μs~21.6A/μs	10mA/μs~43.2A/μs	20mA/μs~86.4A/μs
	Slew Rate(Adv.)	2mA/μs~2.16A/μs	10mA/μs~10.8A/μs	20mA/μs~21.6A/μs
	Min. Rise Time(Pro.)	10μs(Typical)		
	Min. Rise Time(Adv.)	50μs(Typical)		
	Resolution	2mA/μs	10mA/μs	20mA/μs
	Accuracy	5%±10us		
Measurement				
Voltage	Range	0~16V	0~80V	0~200V
	Resolution	0.1mV	0.5mV	2mV
	Accuracy	0.015%+0.015%F.S.		
Current	Range	0~216A	0~1080A	0~2160A
	Resolution	2mA	10mA	20mA
	Accuracy	0.04%+0.04%F.S.		
Power	Range	0~1980W	0~9900W	0~19800W
	Resolution	100mW	500mW	1000mW
	Accuracy	0.1%+0.1%F.S.		
Sampling Frequency	500kHz			
Protection				
OVP	17.6V	88V	220V	
OCP	220.32A	1101.6A	2203.2A	
OPP	2039.4W	10197W	20394W	
Over Temperature	70~75°C			
Overvoltage Safety Value	110%VF.S.			
Reverse Alarm	Yes			
Alarm Tone	Yes			
Mechanical				
Dimensions(WxHxD)	423.0x444.0x670.0mm			
Package Dimensions(WxHxD)	544.0x741.0x891.0mm			
Unit Weight	105.5kg			
Shipping Weight	127.5kg			
AC Input				
Voltage	100~240Vac			
Frequency	50~60Hz			
Power	700VA			
Fuse	8A			

MODEL		EL200VDC22000W		
Rated	Voltage	0~200V		
	Current	0~2400A		
	Power	0~22000W		
	Min. Operating Voltage	0.18V@240A	0.9V@1200A	1.8V@2400A
Static Mode				
Constant Current Mode	Range	0~240A	0~1200A	0~2400A
	Resolution	4mA	20mA	40mA
	Accuracy	0.05%+0.05%F.S.		
Constant Voltage Mode	Range	0~16V	0~80V	0~200V
	Resolution	0.1mV	0.5mV	2mV
	Accuracy	0.025%+0.025%F.S.		
Constant Power Mode	Range	0~2200W	0~11000W	0~22000W
	Resolution	100mW	500mW	1000mW
	Accuracy	0.2%+0.2%F.S.		
Constant Resistance Mode	Range	1.5mΩ~15Ω(16V)	6mΩ~60Ω(80V)	150mΩ~300Ω(200V)
	Resolution	1.5mΩ(16V)	6mΩ(80V)	150mΩ(200V)
	Accuracy	Vin/Rset*(0.2%)+0.2% I.F.S.		
Dynamic Mode				
CCD/CRD	T1&T2(Pro.)	0.02ms~300s		
	T1&T2(Adv.)	0.05ms~300s		
	Resolution	1μs		
	Accuracy	1μs+100ppm		
	Slew Rate(Pro.)	4mA/μs~24A/μs	20mA/μs~48A/μs	40mA/μs~96A/μs
	Slew Rate(Adv.)	4mA/μs~2.4A/μs	20mA/μs~12A/μs	40mA/μs~24A/μs
	Min. Rise Time(Pro.)	10μs(Typical)		
	Min. Rise Time(Adv.)	50μs(Typical)		
	Resolution	4mA/μs	20mA/μs	40mA/μs
	Accuracy	5%±10us		
Measurement				
Voltage	Range	0~16V	0~80V	0~200V
	Resolution	0.1mV	0.5mV	2mV
	Accuracy	0.015%+0.015%F.S.		
Current	Range	0~240A	0~1200A	0~2400A
	Resolution	4mA	20mA	40mA
	Accuracy	0.04%+0.04%F.S.		
Power	Range	0~2200W	0~11000W	0~22000W
	Resolution	100mW	500mW	1000mW
	Accuracy	0.1%+0.1%F.S.		
Sampling Frequency	500kHz			
Protection				
OVP	17.6V	88V	220V	
OCP	244.8A	1224A	2448A	
OPP	2266W	11330W	22660W	
Over Temperature	70~75°C			
Overvoltage Safety Value	110%VF.S.			
Reverse Alarm	Yes			
Alarm Tone	Yes			
Mechanical				
Dimensions(WxHxD)	423.0x577.0x670.0mm			
Package Dimensions(WxHxD)	541.0x861.0x891.0mm			
Unit Weight	129kg			
Shipping Weight	153kg			
AC Input				
Voltage	100~240Vac			
Frequency	50~60Hz			
Power	900VA			
Fuse	10A			

MODEL		EL200VDC24200W		
Rated	Voltage	0~200V		
	Current	0~2640A		
	Power	0~24200W		
	Min. Operating Voltage	0.18V@264A	0.9V@1320A	1.8V@2064A
Static Mode				
Constant Current Mode	Range	0~264A	0~1320A	0~2640A
	Resolution	4mA	20mA	40mA
	Accuracy	0.05%+0.05%F.S.		
Constant Voltage Mode	Range	0~16V	0~80V	0~200V
	Resolution	0.1mV	0.5mV	2mV
	Accuracy	0.025%+0.025%F.S.		
Constant Power Mode	Range	0~2420W	0~12100W	0~24200W
	Resolution	100mW	500mW	1000mW
	Accuracy	0.2%+0.2%F.S.		
Constant Resistance Mode	Range	1.5mΩ~15Ω(16V)	6mΩ~60Ω(80V)	150mΩ~300Ω(200V)
	Resolution	1.5mΩ(16V)	6mΩ(80V)	150mΩ(200V)
	Accuracy	Vin/Rset*(0.2%)+0.2% I.F.S.		
Dynamic Mode				
CCD/CRD	T1&T2(Pro.)	0.02ms~300s		
	T1&T2(Adv.)	0.05ms~300s		
	Resolution	1μs		
	Accuracy	1μs+100ppm		
	Slew Rate(Pro.)	4mA/μs~26.4A/μs	20mA/μs~52.8A/μs	40mA/μs~105.6A/μs
	Slew Rate(Adv.)	4mA/μs~2.64A/μs	20mA/μs~13.2A/μs	40mA/μs~26.4A/μs
	Min. Rise Time(Pro.)	10μs(Typical)		
	Min. Rise Time(Adv.)	50μs(Typical)		
	Resolution	4mA/μs	20mA/μs	40mA/μs
	Accuracy	5%±10us		
Measurement				
Voltage	Range	0~16V	0~80V	0~200V
	Resolution	0.1mV	0.5mV	2mV
	Accuracy	0.015%+0.015%F.S.		
Current	Range	0~264A	0~1320A	0~2640A
	Resolution	4mA	20mA	40mA
	Accuracy	0.04%+0.04%F.S.		
Power	Range	0~2420W	0~12100W	0~24200W
	Resolution	100mW	500mW	1000mW
	Accuracy	0.1%+0.1%F.S.		
Sampling Frequency	500kHz			
Protection				
OVP	17.6V	88V	220V	
OCP	269.28A	1346.4A	2692.8A	
OPP	2492.6W	12463W	24926W	
Over Temperature	70~75°C			
Overvoltage Safety Value	110% V.F.S.			
Reverse Alarm	Yes			
Alarm Tone	Yes			
Mechanical				
Dimensions(WxHxD)	423.0x577.0x670.0mm			
Package Dimensions(WxHxD)	541.0x861.0x891.0mm			
Unit Weight	134.5kg			
Shipping Weight	158.5kg			
AC Input				
Voltage	100~240Vac			
Frequency	50~60Hz			
Power	900VA			
Fuse	10A			

MODEL		EL200VDC26400W		
Rated	Voltage	0~200V		
	Current	0~2880A		
	Power	0~26400W		
	Min. Operating Voltage	0.18V@288A	0.9V@1440A	1.8V@2880A
Static Mode				
Constant Current Mode	Range	0~288A	0~1440A	0~2880A
	Resolution	4mA	20mA	40mA
	Accuracy	0.05%+0.05%F.S.		
Constant Voltage Mode	Range	0~16V	0~80V	0~200V
	Resolution	0.1mV	0.5mV	2mV
	Accuracy	0.025%+0.025%F.S.		
Constant Power Mode	Range	0~2640W	0~13200W	0~26400W
	Resolution	100mW	500mW	1000mW
	Accuracy	0.2%+0.2%F.S.		
Constant Resistance Mode	Range	1.3mΩ~12.5Ω(16V)	5mΩ~50Ω(80V)	125mΩ~250Ω(200V)
	Resolution	1.3mΩ(16V)	5mΩ(80V)	125mΩ(200V)
	Accuracy	Vin/Rset*(0.2%)+0.2% I.F.S.		
Dynamic Mode				
CCD/CRD	T1&T2(Pro.)	0.02ms~300s		
	T1&T2(Adv.)	0.05ms~300s		
	Resolution	1μs		
	Accuracy	1μs+100ppm		
	Slew Rate(Pro.)	4mA/μs~28.8A/μs	20mA/μs~57.6A/μs	40mA/μs~115.2A/μs
	Slew Rate(Adv.)	4mA/μs~2.88A/μs	20mA/μs~14.4A/μs	40mA/μs~28.8A/μs
	Min. Rise Time(Pro.)	10μs(Typical)		
	Min. Rise Time(Adv.)	50μs(Typical)		
	Resolution	4mA/μs	20mA/μs	40mA/μs
	Accuracy	5%±10us		
Measurement				
Voltage	Range	0~16V	0~80V	0~200V
	Resolution	0.1mV	0.5mV	2mV
	Accuracy	0.015%+0.015%F.S.		
Current	Range	0~288A	0~1440A	0~2880A
	Resolution	4mA	20mA	40mA
	Accuracy	0.04%+0.04%F.S.		
Power	Range	0~2640W	0~13200W	0~26400W
	Resolution	100mW	500mW	1000mW
	Accuracy	0.1%+0.1%F.S.		
Sampling Frequency	500kHz			
Protection				
OVP	17.6V	88V	220V	
OCP	293.76A	1468.8A	2937.6A	
OPP	2719.2W	13596W	27192W	
Over Temperature	70~75°C			
Overvoltage Safety Value	110%VF.S.			
Reverse Alarm	Yes			
Alarm Tone	Yes			
Mechanical				
Dimensions(WxHxD)	423.0x577.0x670.0mm			
Package Dimensions(WxHxD)	541.0x861.0x891.0mm			
Unit Weight	140kg			
Shipping Weight	164kg			
AC Input				
Voltage	100~240Vac			
Frequency	50~60Hz			
Power	900VA			
Fuse	10A			

200V Series System Specifications			
Non Linear Mode			
Range	CL	30uF~50000uF	
	RL	As CR Mode	
	Ls	0.1uH~16uH	
	Rs	30mΩ~20Ω	
Resolution	CL	1uF	
	RL	As CR Mode	
	Ls	0.1uH	
	Rs	1mΩ	
Battery Discharge Mode			
Battery Voltage	As CV Mode		
Current Resolution	As CC Mode		
Record	AH/WH		
Test Time	1s~100000s		
Time Resolution	1s		
Program Mode			
Step No.	300 Max.		
Dwell	0.1ms~4000s		
Spec Check	Voltage/Current/Power		
External Waveform Control/Monitor			
Control/Monitor	Voltage/Current		
Input/Ouput Range	0~10V		
Voltage Range	0~L_range F.S.	0~M_range F.S.	0~H_range F.S.
Current Range	0~L_range F.S.	0~M_range F.S.	0~H_range F.S.
Accuracy	0.4%F.S.		
Resolution	4mV		
Bandwidth	20kHz		
Input Impedance	10kΩ		
Short Circuit			
Current(CC)	Full range current value		
Voltage(CV)	Voltage value at the Max power in working mode		
Resistance(CR)	Min resistance value of CR Mode		
Master/Slave			
Parallel Interface	RJ45		
Parallel Quantity (Pro.)	20 units		
Parallel Quantity (Adv.)	10 units		
General			
Graphic Display	4.3" Color touch LCD		
Operation Key Feature	Soft key, Numeric key, Rotary Knob, USB port for transfer and upgrading firmware		
Rack Mount Handles	Yes		
FAN	Temperature Control		
Interface	RS232/RS485/USB(Standard), GPIB/LAN(Optional)		
Communication Response Time	30ms		
Storage Capacity	User defined settings (300 sets), OCP settings (10 sets), OPP settings (10 sets), Default settings (1 set), Factory setting (1 set)		
Environmental			
Operating Temperature	0~40°C		
Storage Temperature	-20~80°C		
Temperature Coefficient	100ppm/°C(Typical)		
Relative Humidity	10~90%RH		
Altitude	≤2000m		
Regulatory Compliance			
Overvoltage Category	II		
Protection Degree	I		
Pollution Degree	II		
Input Impedance	800kΩ(Typical)		
Isolation Voltage	/		
Certificates	CE		

All specifications are subject to change without notice.

MODEL		EL600VDC1200W		
Rated	Voltage	0~600V		
	Current	0~90A		
	Power	0~1200W		
	Min. Operating Voltage	0.8V@9A	4V@45A	8V@90A
Static Mode				
Constant Current Mode	Range	0~9A	0~45A	0~90A
	Resolution	0.1mA	0.5mA	1mA
	Accuracy	0.05%+0.05%F.S.		
Constant Voltage Mode	Range	0~80V	0~150V	0~600V
	Resolution	0.5mV	1mV	5mV
	Accuracy	0.025%+0.025%F.S.		
Constant Power Mode	Range	0~120W	0~600W	0~1200W
	Resolution	10mW	50mW	100mW
	Accuracy	0.2%+0.2%F.S.		
Constant Resistance Mode	Range	275mΩ~2750Ω(80V)	1100mΩ~11000Ω(150V)	11000mΩ~22000Ω(600V)
	Resolution	275mΩ(80V)	1100mΩ(150V)	11000mΩ(600V)
	Accuracy	Vin/Rset*(0.2%)+0.2% I.F.S.		
Dynamic Mode				
CCD/CRD	T1&T2(Pro.)	0.02ms~300s		
	T1&T2(Adv.)	0.05ms~300s		
	Resolution	1μs		
	Accuracy	1μs+100ppm		
	Slew Rate(Pro.)	0.1mA/μs~0.9A/μs	0.5mA/μs~3.15A/μs	1mA/μs~6.3A/μs
	Slew Rate(Adv.)	0.1mA/μs~0.09A/μs	0.5mA/μs~0.45A/μs	1mA/μs~0.9A/μs
	Min. Rise Time(Pro.)	10μs(Typical)		
	Min. Rise Time(Adv.)	50μs(Typical)		
	Resolution	0.1mA/μs	0.5mA/μs	1mA/μs
	Accuracy	5%±10us		
Measurement				
Voltage	Range	0~80V	0~150V	0~600V
	Resolution	0.5mV	1mV	5mV
	Accuracy	0.015%+0.015%F.S.		
Current	Range	0~9A	0~45A	0~90A
	Resolution	0.1mA	0.5mA	1mA
	Accuracy	0.04%+0.04%F.S.		
Power	Range	0~120W	0~600W	0~1200W
	Resolution	10mW	50mW	100mW
	Accuracy	0.1%+0.1%F.S.		
Sampling Frequency	500kHz			
Protection				
OVP	88V	165V	660V	
OCP	9.18A	45.9A	91.8A	
OPP	123.6W	618W	1236W	
Over Temperature	70~75°C			
Overvoltage Safety Value	110%V.F.S.			
Reverse Alarm	Yes			
Alarm Tone	Yes			
Mechanical				
Dimensions(WxHxD)	423.0x88.0x610.0mm			
Package Dimensions(WxHxD)	665.0x333.0x918.0mm			
Unit Weight	20kg			
Shipping Weight	29kg			
AC Input				
Voltage	100~240Vac			
Frequency	50~60Hz			
Power	150VA			
Fuse	2.5A			

MODEL		EL600VDC1800W		
Rated	Voltage	0~600V		
	Current	0~130A		
	Power	0~1800W		
	Min. Operating Voltage	0.8V@13A	4V@65A	8V@130A
Static Mode				
Constant Current Mode	Range	0~13A	0~65A	0~130A
	Resolution	0.1mA	0.5mA	1mA
	Accuracy	0.05%+0.05%F.S.		
Constant Voltage Mode	Range	0~80V	0~150V	0~600V
	Resolution	0.5mV	1mV	5mV
	Accuracy	0.025%+0.025%F.S.		
Constant Power Mode	Range	0~180W	0~900W	0~1800W
	Resolution	10mW	50mW	100mW
	Accuracy	0.2%+0.2%F.S.		
Constant Resistance Mode	Range	200mΩ~2000Ω(80V)	800mΩ~8000Ω(150V)	8000mΩ~16000Ω(600V)
	Resolution	200mΩ(80V)	800mΩ(150V)	8000mΩ(600V)
	Accuracy	Vin/Rset*(0.2%)+0.2% I.F.S.		
Dynamic Mode				
CCD/CRD	T1&T2(Pro.)	0.02ms~300s		
	T1&T2(Adv.)	0.05ms~300s		
	Resolution	1μs		
	Accuracy	1μs+100ppm		
	Slew Rate(Pro.)	0.1mA/μs~1.3A/μs	0.5mA/μs~4.55A/μs	1mA/μs~9.1A/μs
	Slew Rate(Adv.)	0.1mA/μs~0.13A/μs	0.5mA/μs~0.65A/μs	1mA/μs~1.3A/μs
	Min. Rise Time(Pro.)	10μs(Typical)		
	Min. Rise Time(Adv.)	50μs(Typical)		
	Resolution	0.1mA/μs	0.5mA/μs	1mA/μs
	Accuracy	5%±10us		
Measurement				
Voltage	Range	0~80V	0~150V	0~600V
	Resolution	0.5mV	1mV	5mV
	Accuracy	0.015%+0.015%F.S.		
Current	Range	0~13A	0~65A	0~130A
	Resolution	0.1mA	0.5mA	1mA
	Accuracy	0.04%+0.04%F.S.		
Power	Range	0~180W	0~900W	0~1800W
	Resolution	10mW	50mW	100mW
	Accuracy	0.1%+0.1%F.S.		
Sampling Frequency	500kHz			
Protection				
OVP	88V	165V	660V	
OCP	13.26A	66.3A	132.6A	
OPP	185.4W	927W	1854W	
Over Temperature	70~75°C			
Overvoltage Safety Value	110%VF.S.			
Reverse Alarm	Yes			
Alarm Tone	Yes			
Mechanical				
Dimensions(WxHxD)	423.0x88.0x610.0mm			
Package Dimensions(WxHxD)	665.0x333.0x918.0mm			
Unit Weight	22kg			
Shipping Weight	31kg			
AC Input				
Voltage	100~240Vac			
Frequency	50~60Hz			
Power	150VA			
Fuse	2.5A			

MODEL		EL600VDC2400W		
Rated	Voltage	0~600V		
	Current	0~180A		
	Power	0~2400W		
	Min. Operating Voltage	0.8V@18A	4V@90A	8V@180A
Static Mode				
Constant Current Mode	Range	0~18A	0~90A	0~180A
	Resolution	0.2mA	1mA	2mA
	Accuracy	0.05%+0.05%F.S.		
Constant Voltage Mode	Range	0~80V	0~150V	0~600V
	Resolution	0.5mV	1mV	5mV
	Accuracy	0.025%+0.025%F.S.		
Constant Power Mode	Range	0~240W	0~1200W	0~2400W
	Resolution	10mW	50mW	100mW
	Accuracy	0.2%+0.2%F.S.		
Constant Resistance Mode	Range	137.5mΩ~1375Ω(80V)	550mΩ~5500Ω(150V)	5500mΩ~11000Ω(600V)
	Resolution	137.5mΩ(80V)	550mΩ(150V)	5500mΩ(600V)
	Accuracy	Vin/Rset*(0.2%)+0.2% I.F.S.		
Dynamic Mode				
CCD/CRD	T1&T2(Pro.)	0.02ms~300s		
	T1&T2(Adv.)	0.05ms~300s		
	Resolution	1μs		
	Accuracy	1μs+100ppm		
	Slew Rate(Pro.)	0.2mA/μs~1.8A/μs	1mA/μs~6.3A/μs	2mA/μs~12.6A/μs
	Slew Rate(Adv.)	0.2mA/μs~0.18A/μs	1mA/μs~0.9A/μs	2mA/μs~1.8A/μs
	Min. Rise Time(Pro.)	10μs(Typical)		
	Min. Rise Time(Adv.)	50μs(Typical)		
	Resolution	0.2mA/μs	1mA/μs	2mA/μs
	Accuracy	5%±10us		
Measurement				
Voltage	Range	0~80V	0~150V	0~600V
	Resolution	0.5mV	1mV	5mV
	Accuracy	0.015%+0.015%F.S.		
Current	Range	0~18A	0~90A	0~180A
	Resolution	0.2mA	1mA	2mA
	Accuracy	0.04%+0.04%F.S.		
Power	Range	0~240W	0~1200W	0~2400W
	Resolution	10mW	50mW	100mW
	Accuracy	0.1%+0.1%F.S.		
Sampling Frequency	500kHz			
Protection				
OVP	88V	165V	660V	
OCP	18.36A	91.8A	183.6A	
OPP	247.2W	1236W	2472W	
Over Temperature	70~75°C			
Overvoltage Safety Value	110%V.F.S.			
Reverse Alarm	Yes			
Alarm Tone	Yes			
Mechanical				
Dimensions(WxHxD)	423.0x88.0x610.0mm			
Package Dimensions(WxHxD)	665.0x333.0x918.0mm			
Unit Weight	24kg			
Shipping Weight	33kg			
AC Input				
Voltage	100~240Vac			
Frequency	50~60Hz			
Power	180VA			
Fuse	2.5A			

MODEL		EL600VDC3000W		
Rated	Voltage	0~600V		
	Current	0~2200A		
	Power	0~3000W		
	Min. Operating Voltage	0.8V@22A	4V@110A	8V@220A
Static Mode				
Constant Current Mode	Range	0~22A	0~110A	0~220A
	Resolution	0.2mA	1mA	2mA
	Accuracy	0.05%+0.05%F.S.		
Constant Voltage Mode	Range	0~80V	0~150V	0~600V
	Resolution	0.5mV	1mV	5mV
	Accuracy	0.025%+0.025%F.S.		
Constant Power Mode	Range	0~300W	0~1500W	0~3000W
	Resolution	10mW	50mW	100mW
	Accuracy	0.2%+0.2%F.S.		
Constant Resistance Mode	Range	110mΩ~1100Ω(80V)	440mΩ~4400Ω(150V)	4400mΩ~8800Ω(600V)
	Resolution	110mΩ(80V)	440mΩ(150V)	4400mΩ(600V)
	Accuracy	Vin/Rset*(0.2%)+0.2% I.F.S.		
Dynamic Mode				
CCD/CRD	T1&T2(Pro.)	0.02ms~300s		
	T1&T2(Adv.)	0.05ms~300s		
	Resolution	1μs		
	Accuracy	1μs+100ppm		
	Slew Rate(Pro.)	0.2mA/μs~2.2A/μs	1mA/μs~7.7A/μs	2mA/μs~15.4A/μs
	Slew Rate(Adv.)	0.2mA/μs~0.22A/μs	1mA/μs~1.1A/μs	2mA/μs~2.2A/μs
	Min. Rise Time(Pro.)	10μs(Typical)		
	Min. Rise Time(Adv.)	50μs(Typical)		
	Resolution	0.2mA/μs	1mA/μs	2mA/μs
	Accuracy	5%±10us		
Measurement				
Voltage	Range	0~80V	0~150V	0~600V
	Resolution	0.5mV	1mV	5mV
	Accuracy	0.015%+0.015%F.S.		
Current	Range	0~22A	0~110A	0~220A
	Resolution	0.2mA	1mA	2mA
	Accuracy	0.04%+0.04%F.S.		
Power	Range	0~300W	0~1500W	0~3000W
	Resolution	10mW	50mW	100mW
	Accuracy	0.1%+0.1%F.S.		
Sampling Frequency	500kHz			
Protection				
OVP	88V	165V	660V	
OCP	22.44A	112.2A	224.4A	
OPP	309W	1545W	3090W	
Over Temperature	70~75°C			
Overvoltage Safety Value	110%V.F.S.			
Reverse Alarm	Yes			
Alarm Tone	Yes			
Mechanical				
Dimensions(WxHxD)	423.0x88.0x610.0mm			
Package Dimensions(WxHxD)	665.0x333.0x918.0mm			
Unit Weight	26kg			
Shipping Weight	35kg			
AC Input				
Voltage	100~240Vac			
Frequency	50~60Hz			
Power	180VA			
Fuse	2.5A			

MODEL		EL600VDC3400W		
Rated	Voltage	0~600V		
	Current	0~250A		
	Power	0~3400W		
	Min. Operating Voltage	0.8V@25A	4V@125A	8V@250A
Static Mode				
Constant Current Mode	Range	0~25A	0~125A	0~250A
	Resolution	0.4mA	2mA	4mA
	Accuracy	0.05%+0.05%F.S.		
Constant Voltage Mode	Range	0~80V	0~150V	0~600V
	Resolution	0.5mV	1mV	5mV
	Accuracy	0.025%+0.025%F.S.		
Constant Power Mode	Range	0~340W	0~1700W	0~3400W
	Resolution	10mW	50mW	100mW
	Accuracy	0.2%+0.2%F.S.		
Constant Resistance Mode	Range	100mΩ~1000Ω(80V)	400mΩ~4000Ω(150V)	4000mΩ~8000Ω(600V)
	Resolution	100mΩ(80V)	400mΩ(150V)	4000mΩ(600V)
	Accuracy	Vin/Rset*(0.2%)+0.2% I.F.S.		
Dynamic Mode				
CCD/CRD	T1&T2(Pro.)	0.02ms~300s		
	T1&T2(Adv.)	0.05ms~300s		
	Resolution	1μs		
	Accuracy	1μs+100ppm		
	Slew Rate(Pro.)	0.4mA/μs~1A/μs	2mA/μs~5A/μs	4mA/μs~10A/μs
	Slew Rate(Adv.)	0.4mA/μs~0.25A/μs	2mA/μs~1.25A/μs	4mA/μs~2.5A/μs
	Min. Rise Time(Pro.)	20μs(Typical)		
	Min. Rise Time(Adv.)	50μs(Typical)		
	Resolution	0.4mA/μs	2mA/μs	4mA/μs
	Accuracy	5%±10us		
Measurement				
Voltage	Range	0~80V	0~150V	0~600V
	Resolution	0.5mV	1mV	5mV
	Accuracy	0.015%+0.015%F.S.		
Current	Range	0~25A	0~125A	0~250A
	Resolution	0.4mA	2mA	4mA
	Accuracy	0.04%+0.04%F.S.		
Power	Range	0~340W	0~1700W	0~3400W
	Resolution	10mW	50mW	100mW
	Accuracy	0.1%+0.1%F.S.		
Sampling Frequency	500kHz			
Protection				
OVP	88V	165V	660V	
OCP	25.5A	127.5A	255A	
OPP	350.2W	1751W	3502W	
Over Temperature	70~75°C			
Overvoltage Safety Value	110%V.F.S.			
Reverse Alarm	Yes			
Alarm Tone	Yes			
Mechanical				
Dimensions(WxHxD)	423.0x133.0x610.0mm			
Package Dimensions(WxHxD)	665.0x348.0x918.0mm			
Unit Weight	27kg			
Shipping Weight	36kg			
AC Input				
Voltage	100~240Vac			
Frequency	50~60Hz			
Power	200VA			
Fuse	2.5A			

MODEL		EL600VDC4400W		
Rated	Voltage	0~600V		
	Current	0~320A		
	Power	0~4400W		
	Min. Operating Voltage	0.8V@32A	4V@160A	8V@320A
Static Mode				
Constant Current Mode	Range	0~32A	0~160A	0~320A
	Resolution	0.4mA	2mA	4mA
	Accuracy	0.05%+0.05%F.S.		
Constant Voltage Mode	Range	0~80V	0~150V	0~600V
	Resolution	0.5mV	1mV	5mV
	Accuracy	0.025%+0.025%F.S.		
Constant Power Mode	Range	0~440W	0~2200W	0~4400W
	Resolution	10mW	50mW	100mW
	Accuracy	0.2%+0.2%F.S.		
Constant Resistance Mode	Range	75mΩ~750Ω(80V)	300mΩ~3000Ω(150V)	3000mΩ~6000Ω(600V)
	Resolution	75mΩ(80V)	300mΩ(150V)	3000mΩ(600V)
	Accuracy	Vin/Rset*(0.2%)+0.2% I.F.S.		
Dynamic Mode				
CCD/CRD	T1&T2(Pro.)	0.02ms~300s		
	T1&T2(Adv.)	0.05ms~300s		
	Resolution	1μs		
	Accuracy	1μs+100ppm		
	Slew Rate(Pro.)	0.4mA/μs~1.28A/μs	2mA/μs~6.4A/μs	4mA/μs~12.8A/μs
	Slew Rate(Adv.)	0.4mA/μs~0.32A/μs	2mA/μs~1.6A/μs	4mA/μs~3.2A/μs
	Min. Rise Time(Pro.)	20μs(Typical)		
	Min. Rise Time(Adv.)	50μs(Typical)		
	Resolution	0.4mA/μs	2mA/μs	4mA/μs
	Accuracy	5%±10us		
Measurement				
Voltage	Range	0~80V	0~150V	0~600V
	Resolution	0.5mV	1mV	5mV
	Accuracy	0.015%+0.015%F.S.		
Current	Range	0~32A	0~160A	0~320A
	Resolution	0.4mA	2mA	4mA
	Accuracy	0.04%+0.04%F.S.		
Power	Range	0~440W	0~2200W	0~4400W
	Resolution	10mW	50mW	100mW
	Accuracy	0.1%+0.1%F.S.		
Sampling Frequency	500kHz			
Protection				
OVP	88V	165V	660V	
OCP	32.6A	163.2A	326.4A	
OPP	453.2W	2266W	4532W	
Over Temperature	70~75°C			
Overvoltage Safety Value	110%VF.S.			
Reverse Alarm	Yes			
Alarm Tone	Yes			
Mechanical				
Dimensions(WxHxD)	423.0x133.0x610.0mm			
Package Dimensions(WxHxD)	665.0x348.0x918.0mm			
Unit Weight	28.5kg			
Shipping Weight	37.3kg			
AC Input				
Voltage	100~240Vac			
Frequency	50~60Hz			
Power	200VA			
Fuse	2.5A			

MODEL		EL600VDC5600W		
Rated	Voltage	0~600V		
	Current	0~410A		
	Power	0~5600W		
	Min. Operating Voltage	0.8V@41A	4V@205A	8V@410A
Static Mode				
Constant Current Mode	Range	0~41A	0~205A	0~410A
	Resolution	0.4mA	2mA	4mA
	Accuracy	0.05%+0.05%F.S.		
Constant Voltage Mode	Range	0~80V	0~150V	0~600V
	Resolution	0.5mV	1mV	5mV
	Accuracy	0.025%+0.025%F.S.		
Constant Power Mode	Range	0~560W	0~2800W	0~5600W
	Resolution	10mW	50mW	100mW
	Accuracy	0.2%+0.2%F.S.		
Constant Resistance Mode	Range	60mΩ~600Ω(80V)	250mΩ~2500Ω(150V)	2500mΩ~5000Ω(600V)
	Resolution	60mΩ(80V)	250mΩ(150V)	2500mΩ(600V)
	Accuracy	Vin/Rset*(0.2%)+0.2% IF.S.		
Dynamic Mode				
CCD/CRD	T1&T2(Pro.)	0.02ms~300s		
	T1&T2(Adv.)	0.05ms~300s		
	Resolution	1μs		
	Accuracy	1μs+100ppm		
	Slew Rate(Pro.)	0.4mA/μs~1.64A/μs	2mA/μs~8.2A/μs	4mA/μs~16.4A/μs
	Slew Rate(Adv.)	0.4mA/μs~0.41A/μs	2mA/μs~2.05A/μs	4mA/μs~4.1A/μs
	Min. Rise Time(Pro.)	20μs(Typical)		
	Min. Rise Time(Adv.)	50μs(Typical)		
	Resolution	0.4mA/μs	2mA/μs	4mA/μs
	Accuracy	5%±10us		
Measurement				
Voltage	Range	0~80V	0~150V	0~600V
	Resolution	0.5mV	1mV	5mV
	Accuracy	0.015%+0.015%F.S.		
Current	Range	0~41A	0~205A	0~410A
	Resolution	0.4mA	2mA	4mA
	Accuracy	0.04%+0.04%F.S.		
Power	Range	0~560W	0~2800W	0~5600W
	Resolution	10mW	50mW	100mW
	Accuracy	0.1%+0.1%F.S.		
Sampling Frequency	500kHz			
Protection				
OVP	88V	165V	660V	
OCP	41.82A	209.1A	418.2A	
OPP	576.8W	2884W	5768W	
Over Temperature	70~75°C			
Overvoltage Safety Value	110%VF.S.			
Reverse Alarm	Yes			
Alarm Tone	Yes			
Mechanical				
Dimensions(WxHxD)	423.0x133.0x610.0mm			
Package Dimensions(WxHxD)	665.0x348.0x918.0mm			
Unit Weight	32.5kg			
Shipping Weight	41.3kg			
AC Input				
Voltage	100~240Vac			
Frequency	50~60Hz			
Power	200VA			
Fuse	2.5A			

MODEL		EL600VDC6600W		
Rated	Voltage	0~600V		
	Current	0~480A		
	Power	0~6600W		
	Min. Operating Voltage	0.8V@48A	4V@240A	8V@480A
Static Mode				
Constant Current Mode	Range	0~48A	0~240A	0~480A
	Resolution	0.5mA	2mA	5mA
	Accuracy	0.05%+0.05%F.S.		
Constant Voltage Mode	Range	0~80V	0~150V	0~600V
	Resolution	0.5mV	1mV	5mV
	Accuracy	0.025%+0.025%F.S.		
Constant Power Mode	Range	0~660W	0~3300W	0~6600W
	Resolution	10mW	50mW	100mW
	Accuracy	0.2%+0.2%F.S.		
Constant Resistance Mode	Range	50mΩ~500Ω(80V)	200mΩ~2000Ω(150V)	2000mΩ~4000Ω(600V)
	Resolution	50mΩ(80V)	200mΩ(150V)	2000mΩ(600V)
	Accuracy	Vin/Rset*(0.2%)+0.2% I.F.S.		
Dynamic Mode				
CCD/CRD	T1&T2(Pro.)	0.02ms~300s		
	T1&T2(Adv.)	0.05ms~300s		
	Resolution	1μs		
	Accuracy	1μs+100ppm		
	Slew Rate(Pro.)	0.5mA/μs~1.92A/μs	2mA/μs~9.6A/μs	5mA/μs~19.2A/μs
	Slew Rate(Adv.)	0.5mA/μs~0.48A/μs	2mA/μs~2.4A/μs	5mA/μs~4.8A/μs
	Min. Rise Time(Pro.)	20μs(Typical)		
	Min. Rise Time(Adv.)	50μs(Typical)		
	Resolution	0.5mA/μs	2mA/μs	5mA/μs
	Accuracy	5%±10us		
Measurement				
Voltage	Range	0~80V	0~150V	0~600V
	Resolution	0.5mV	1mV	5mV
	Accuracy	0.015%+0.015%F.S.		
Current	Range	0~48A	0~240A	0~480A
	Resolution	0.5mA	2mA	5mA
	Accuracy	0.04%+0.04%F.S.		
Power	Range	0~660W	0~3300W	0~6600W
	Resolution	10mW	50mW	100mW
	Accuracy	0.1%+0.1%F.S.		
Sampling Frequency	500kHz			
Protection				
OVP	88V	165V	660V	
OCP	48.96A	244.8A	489.6A	
OPP	679.8W	3399W	6798W	
Over Temperature	70~75°C			
Overvoltage Safety Value	110%VF.S.			
Reverse Alarm	Yes			
Alarm Tone	Yes			
Mechanical				
Dimensions(WxHxD)	423.0x177.0x610.0mm			
Package Dimensions(WxHxD)	665.0x392.0x918.0mm			
Unit Weight	38kg			
Shipping Weight	47kg			
AC Input				
Voltage	100~240Vac			
Frequency	50~60Hz			
Power	250VA			
Fuse	3.15A			

MODEL		EL600VDC8800W		
Rated	Voltage	0~600V		
	Current	0~640A		
	Power	0~8800W		
	Min. Operating Voltage	0.8V@64A	4V@320A	8V@640A
Static Mode				
Constant Current Mode	Range	0~64A	0~320A	0~640A
	Resolution	0.5mA	2mA	5mA
	Accuracy	0.05%+0.05%F.S.		
Constant Voltage Mode	Range	0~80V	0~150V	0~600V
	Resolution	0.5mV	1mV	5mV
	Accuracy	0.025%+0.025%F.S.		
Constant Power Mode	Range	0~880W	0~4400W	0~8800W
	Resolution	20mW	100mW	200mW
	Accuracy	0.2%+0.2%F.S.		
Constant Resistance Mode	Range	37.5mΩ~375Ω(80V)	150mΩ~1500Ω(150V)	1500mΩ~3000Ω(600V)
	Resolution	37.5mΩ(80V)	150mΩ(150V)	1500mΩ(600V)
	Accuracy	Vin/Rset*(0.2%)+0.2% I.F.S.		
Dynamic Mode				
CCD/CRD	T1&T2(Pro.)	0.02ms~300s		
	T1&T2(Adv.)	0.05ms~300s		
	Resolution	1μs		
	Accuracy	1μs+100ppm		
	Slew Rate(Pro.)	0.5mA/μs~2.56A/μs	2mA/μs~12.8A/μs	5mA/μs~25.6A/μs
	Slew Rate(Adv.)	0.5mA/μs~0.64A/μs	2mA/μs~3.2A/μs	5mA/μs~6.4A/μs
	Min. Rise Time(Pro.)	20μs(Typical)		
	Min. Rise Time(Adv.)	50μs(Typical)		
	Resolution	0.5mA/μs	2mA/μs	5mA/μs
	Accuracy	5%±10us		
Measurement				
Voltage	Range	0~80V	0~150V	0~600V
	Resolution	0.5mV	1mV	5mV
	Accuracy	0.015%+0.015%F.S.		
Current	Range	0~64A	0~320A	0~640A
	Resolution	0.5mA	2mA	5mA
	Accuracy	0.04%+0.04%F.S.		
Power	Range	0~880W	0~4400W	0~8800W
	Resolution	20mW	100mW	200mW
	Accuracy	0.1%+0.1%F.S.		
Sampling Frequency	500kHz			
Protection				
OVP	88V	165V	660V	
OCP	65.28A	326.4A	652.8A	
OPP	906.4W	4532W	9064W	
Over Temperature	70~75°C			
Overvoltage Safety Value	110%VF.S.			
Reverse Alarm	Yes			
Alarm Tone	Yes			
Mechanical				
Dimensions(WxHxD)	423.0x311.0x670.0mm			
Package Dimensions(WxHxD)	541.0x591.0x891.0mm			
Unit Weight	61.5kg			
Shipping Weight	81.5kg			
AC Input				
Voltage	100~240Vac			
Frequency	50~60Hz			
Power	450VA			
Fuse	5A			

MODEL		EL600VDC11000W		
Rated	Voltage	0~600V		
	Current	0~800A		
	Power	0~11000W		
	Min. Operating Voltage	0.8V@80A	4V@400A	8V@800A
Static Mode				
Constant Current Mode	Range	0~80A	0~400A	0~800A
	Resolution	1mA	5mA	10mA
	Accuracy	0.05%+0.05%F.S.		
Constant Voltage Mode	Range	0~80V	0~150V	0~600V
	Resolution	0.5mV	1mV	5mV
	Accuracy	0.025%+0.025%F.S.		
Constant Power Mode	Range	0~1100W	0~5500W	0~11000W
	Resolution	20mW	100mW	200mW
	Accuracy	0.2%+0.2%F.S.		
Constant Resistance Mode	Range	30mΩ~300Ω(80V)	120mΩ~1200Ω(150V)	1200mΩ~2400Ω(600V)
	Resolution	30mΩ(80V)	120mΩ(150V)	1200mΩ(600V)
	Accuracy	Vin/Rset*(0.2%)+0.2% I.F.S.		
Dynamic Mode				
CCD/CRD	T1&T2(Pro.)	0.02ms~300s		
	T1&T2(Adv.)	0.05ms~300s		
	Resolution	1μs		
	Accuracy	1μs+100ppm		
	Slew Rate(Pro.)	1mA/μs~3.2A/μs	5mA/μs~16A/μs	10mA/μs~32A/μs
	Slew Rate(Adv.)	1mA/μs~0.8A/μs	5mA/μs~4A/μs	10mA/μs~8A/μs
	Min. Rise Time(Pro.)	20μs(Typical)		
	Min. Rise Time(Adv.)	50μs(Typical)		
	Resolution	1mA/μs	5mA/μs	10mA/μs
	Accuracy	5%±10us		
Measurement				
Voltage	Range	0~80V	0~150V	0~600V
	Resolution	0.5mV	1mV	5mV
	Accuracy	0.015%+0.015%F.S.		
Current	Range	0~80A	0~400A	0~800A
	Resolution	1mA	5mA	10mA
	Accuracy	0.04%+0.04%F.S.		
Power	Range	0~1100W	0~5500W	0~11000W
	Resolution	20mW	100mW	200mW
	Accuracy	0.1%+0.1%F.S.		
Sampling Frequency	500kHz			
Protection				
OVP	88V	165V	660V	
OCP	81.6A	408A	816A	
OPP	1133W	5665W	11330W	
Over Temperature	70~75°C			
Overvoltage Safety Value	110%V.F.S.			
Reverse Alarm	Yes			
Alarm Tone	Yes			
Mechanical				
Dimensions(WxHxD)	423.0x311.0x670.0mm			
Package Dimensions(WxHxD)	541.0x591.0x891.0mm			
Unit Weight	67kg			
Shipping Weight	87kg			
AC Input				
Voltage	100~240Vac			
Frequency	50~60Hz			
Power	450VA			
Fuse	5A			

MODEL		EL600VDC13200W		
Rated	Voltage	0~600V		
	Current	0~960A		
	Power	0~13200W		
	Min. Operating Voltage	0.8V@96A	4V@480A	8V@960A
Static Mode				
Constant Current Mode	Range	0~96A	0~480A	0~960A
	Resolution	1mA	5mA	10mA
	Accuracy	0.05%+0.05%F.S.		
Constant Voltage Mode	Range	0~80V	0~150V	0~600V
	Resolution	0.5mV	1mV	5mV
	Accuracy	0.025%+0.025%F.S.		
Constant Power Mode	Range	0~1320W	0~6600W	0~13200W
	Resolution	40mW	200mW	400mW
	Accuracy	0.2%+0.2%F.S.		
Constant Resistance Mode	Range	25mΩ~250Ω(80V)	100mΩ~1000Ω(150V)	1000mΩ~2000Ω(600V)
	Resolution	25mΩ(80V)	100mΩ(150V)	1000mΩ(600V)
	Accuracy	Vin/Rset*(0.2%)+0.2%IF.S.		
Dynamic Mode				
CCD/CRD	T1&T2(Pro.)	0.02ms~300s		
	T1&T2(Adv.)	0.05ms~300s		
	Resolution	1μs		
	Accuracy	1μs+100ppm		
	Slew Rate(Pro.)	1mA/μs~3.84A/μs	5mA/μs~19.2A/μs	10mA/μs~38.4A/μs
	Slew Rate(Adv.)	1mA/μs~0.96A/μs	5mA/μs~4.8A/μs	10mA/μs~9.6A/μs
	Min. Rise Time(Pro.)	20μs(Typical)		
	Min. Rise Time(Adv.)	50μs(Typical)		
	Resolution	1mA/μs	5mA/μs	10mA/μs
	Accuracy	5%±10us		
Measurement				
Voltage	Range	0~80V	0~150V	0~600V
	Resolution	0.5mV	1mV	5mV
	Accuracy	0.015%+0.015%F.S.		
Current	Range	0~96A	0~480A	0~960A
	Resolution	1mA	5mA	10mA
	Accuracy	0.04%+0.04%F.S.		
Power	Range	0~1320W	0~6600W	0~13200W
	Resolution	40mW	200mW	400mW
	Accuracy	0.1%+0.1%F.S.		
Sampling Frequency	500kHz			
Protection				
OVP	88V	165V	660V	
OCP	97.92A	489.6A	979.2A	
OPP	1359.6W	6798W	13596W	
Over Temperature	70~75°C			
Overvoltage Safety Value	110%VF.S.			
Reverse Alarm	Yes			
Alarm Tone	Yes			
Mechanical				
Dimensions(WxHxD)	423.0x311.0x670.0mm			
Package Dimensions(WxHxD)	541.0x591.0x891.0mm			
Unit Weight	72.5kg			
Shipping Weight	92.5kg			
AC Input				
Voltage	100~240Vac			
Frequency	50~60Hz			
Power	450VA			
Fuse	5A			

MODEL		EL600VDC15400W		
Rated	Voltage	0~600V		
	Current	0~1120A		
	Power	0~15400W		
	Min. Operating Voltage	0.8V@112A	4V@560A	8V@1120A
Static Mode				
Constant Current Mode	Range	0~112A	0~560A	0~1120A
	Resolution	1mA	5mA	10mA
	Accuracy	0.05%+0.05%F.S.		
Constant Voltage Mode	Range	0~80V	0~150V	0~600V
	Resolution	0.5mV	1mV	5mV
	Accuracy	0.025%+0.025%F.S.		
Constant Power Mode	Range	0~1540W	0~7700W	0~15400W
	Resolution	40mW	200mW	400mW
	Accuracy	0.2%+0.2%F.S.		
Constant Resistance Mode	Range	21mΩ~210Ω(80V)	85mΩ~850Ω(150V)	850mΩ~1700Ω(600V)
	Resolution	21mΩ(80V)	85mΩ(150V)	850mΩ(600V)
	Accuracy	Vin/Rset*(0.2%)+0.2% I.F.S.		
Dynamic Mode				
CCD/CRD	T1&T2(Pro.)	0.02ms~300s		
	T1&T2(Adv.)	0.05ms~300s		
	Resolution	1μs		
	Accuracy	1μs+100ppm		
	Slew Rate(Pro.)	1mA/μs~4.48A/μs	5mA/μs~22.4A/μs	10mA/μs~44.8A/μs
	Slew Rate(Adv.)	1mA/μs~1.12A/μs	5mA/μs~5.6A/μs	10mA/μs~11.2A/μs
	Min. Rise Time(Pro.)	20μs(Typical)		
	Min. Rise Time(Adv.)	50μs(Typical)		
	Resolution	1mA/μs	5mA/μs	10mA/μs
	Accuracy	5%±10us		
Measurement				
Voltage	Range	0~80V	0~150V	0~600V
	Resolution	0.5mV	1mV	5mV
	Accuracy	0.015%+0.015%F.S.		
Current	Range	0~112A	0~560A	0~1120A
	Resolution	1mA	5mA	10mA
	Accuracy	0.04%+0.04%F.S.		
Power	Range	0~1540W	0~7700W	0~15400W
	Resolution	40mW	200mW	400mW
	Accuracy	0.1%+0.1%F.S.		
Sampling Frequency	500kHz			
Protection				
OVP	88V	165V	660V	
OCP	114.24A	571.2A	1142.4A	
OPP	1586.2W	7931W	15862W	
Over Temperature	70~75°C			
Overvoltage Safety Value	110%VF.S.			
Reverse Alarm	Yes			
Alarm Tone	Yes			
Mechanical				
Dimensions(WxHxD)	423.0x444.0x670.0mm			
Package Dimensions(WxHxD)	544.0x741.0x891.0mm			
Unit Weight	94.5kg			
Shipping Weight	116.5kg			
AC Input				
Voltage	100~240Vac			
Frequency	50~60Hz			
Power	700VA			
Fuse	8A			

MODEL		EL600VDC17600W		
Rated	Voltage	0~600V		
	Current	0~1280A		
	Power	0~17600W		
	Min. Operating Voltage	0.8V@128A	4V@640A	8V@1280A
Static Mode				
Constant Current Mode	Range	0~128A	0~640A	0~1280A
	Resolution	1mA	5mA	10mA
	Accuracy	0.05%+0.05%F.S.		
Constant Voltage Mode	Range	0~80V	0~150V	0~600V
	Resolution	0.5mV	1mV	5mV
	Accuracy	0.025%+0.025%F.S.		
Constant Power Mode	Range	0~1760W	0~8800W	0~17600W
	Resolution	100mW	500mW	1000mW
	Accuracy	0.2%+0.2%F.S.		
Constant Resistance Mode	Range	18.7mΩ~187Ω(80V)	75mΩ~750Ω(150V)	750mΩ~1500Ω(600V)
	Resolution	18.7mΩ(80V)	75mΩ(150V)	750mΩ(600V)
	Accuracy	Vin/Rset*(0.2%)+0.2% I.F.S.		
Dynamic Mode				
CCD/CRD	T1&T2(Pro.)	0.02ms~300s		
	T1&T2(Adv.)	0.05ms~300s		
	Resolution	1μs		
	Accuracy	1μs+100ppm		
	Slew Rate(Pro.)	1mA/μs~5.12A/μs	5mA/μs~25.6A/μs	10mA/μs~51.2A/μs
	Slew Rate(Adv.)	1mA/μs~1.28A/μs	5mA/μs~6.4A/μs	10mA/μs~12.8A/μs
	Min. Rise Time(Pro.)	20μs(Typical)		
	Min. Rise Time(Adv.)	50μs(Typical)		
	Resolution	1mA/μs	5mA/μs	10mA/μs
	Accuracy	5%±10us		
Measurement				
Voltage	Range	0~80V	0~150V	0~600V
	Resolution	0.5mV	1mV	5mV
	Accuracy	0.015%+0.015%F.S.		
Current	Range	0~128A	0~640A	0~1280A
	Resolution	1mA	5mA	10mA
	Accuracy	0.04%+0.04%F.S.		
Power	Range	0~1760W	0~8800W	0~17600W
	Resolution	100mW	500mW	1000mW
	Accuracy	0.1%+0.1%F.S.		
Sampling Frequency	500kHz			
Protection				
OVP	88V	165V	660V	
OCP	130.56A	652.8A	1305.6A	
OPP	1812.8W	9064W	18128W	
Over Temperature	70~75°C			
Overvoltage Safety Value	110%VF.S.			
Reverse Alarm	Yes			
Alarm Tone	Yes			
Mechanical				
Dimensions(WxHxD)	423.0x444.0x670.0mm			
Package Dimensions(WxHxD)	544.0x741.0x891.0mm			
Unit Weight	100kg			
Shipping Weight	122kg			
AC Input				
Voltage	100~240Vac			
Frequency	50~60Hz			
Power	700VA			
Fuse	8A			

MODEL		EL600VDC19800W		
Rated	Voltage	0~600V		
	Current	0~1440A		
	Power	0~19800W		
	Min. Operating Voltage	0.8V@144A	4V@720A	8V@1440A
Static Mode				
Constant Current Mode	Range	0~144A	0~720A	0~1440A
	Resolution	2mA	10mA	20mA
	Accuracy	0.05%+0.05%F.S.		
Constant Voltage Mode	Range	0~80V	0~150V	0~600V
	Resolution	0.5mV	1mV	5mV
	Accuracy	0.025%+0.025%F.S.		
Constant Power Mode	Range	0~1980W	0~9900W	0~19800W
	Resolution	100mW	500mW	1000mW
	Accuracy	0.2%+0.2%F.S.		
Constant Resistance Mode	Range	16.7mΩ~166.7Ω(80V)	66.7mΩ~666.7Ω(150V)	666.7mΩ~1333Ω(600V)
	Resolution	16.7mΩ(80V)	66.7mΩ(150V)	666.7mΩ(600V)
	Accuracy	Vin/Rset*(0.2%)+0.2% I.F.S.		
Dynamic Mode				
CCD/CRD	T1&T2(Pro.)	0.02ms~300s		
	T1&T2(Adv.)	0.05ms~300s		
	Resolution	1μs		
	Accuracy	1μs+100ppm		
	Slew Rate(Pro.)	2mA/μs~5.76A/μs	10mA/μs~28.8A/μs	20mA/μs~57.6A/μs
	Slew Rate(Adv.)	2mA/μs~1.44A/μs	10mA/μs~7.2A/μs	20mA/μs~14.4A/μs
	Min. Rise Time(Pro.)	20μs(Typical)		
	Min. Rise Time(Adv.)	50μs(Typical)		
	Resolution	2mA/μs	10mA/μs	20mA/μs
	Accuracy	5%±10us		
Measurement				
Voltage	Range	0~80V	0~150V	0~600V
	Resolution	0.5mV	1mV	5mV
	Accuracy	0.015%+0.015%F.S.		
Current	Range	0~144A	0~720A	0~1440A
	Resolution	2mA	10mA	20mA
	Accuracy	0.04%+0.04%F.S.		
Power	Range	0~1980W	0~9900W	0~19800W
	Resolution	100mW	500mW	1000mW
	Accuracy	0.1%+0.1%F.S.		
Sampling Frequency	500kHz			
Protection				
OVP	88V	165V	660V	
OCP	146.88A	734.4A	1468.8A	
OPP	2039.4W	10197W	20394W	
Over Temperature	70~75°C			
Overvoltage Safety Value	110%V.F.S.			
Reverse Alarm	Yes			
Alarm Tone	Yes			
Mechanical				
Dimensions(WxHxD)	423.0x444.0x670.0mm			
Package Dimensions(WxHxD)	544.0x741.0x891.0mm			
Unit Weight	105.5kg			
Shipping Weight	127.5kg			
AC Input				
Voltage	100~240Vac			
Frequency	50~60Hz			
Power	700VA			
Fuse	8A			

MODEL		EL600VDC22000W		
Rated	Voltage	0~600V		
	Current	0~1600A		
	Power	0~22000W		
	Min. Operating Voltage	0.8V@160A	4V@800A	8V@1600A
Static Mode				
Constant Current Mode	Range	0~160A	0~800A	0~1600A
	Resolution	2mA	10mA	20mA
	Accuracy	0.05%+0.05%F.S.		
Constant Voltage Mode	Range	0~80V	0~150V	0~600V
	Resolution	0.5mV	1mV	5mV
	Accuracy	0.025%+0.025%F.S.		
Constant Power Mode	Range	0~2200W	0~11000W	0~22000W
	Resolution	100mW	500mW	1000mW
	Accuracy	0.2%+0.2%F.S.		
Constant Resistance Mode	Range	15mΩ~150Ω(80V)	60mΩ~600Ω(150V)	600mΩ~1200Ω(600V)
	Resolution	15mΩ(80V)	60mΩ(150V)	600mΩ(600V)
	Accuracy	Vin/Rset*(0.2%)+0.2% I.F.S.		
Dynamic Mode				
CCD/CRD	T1&T2(Pro.)	0.02ms~300s		
	T1&T2(Adv.)	0.05ms~300s		
	Resolution	1μs		
	Accuracy	1μs+100ppm		
	Slew Rate(Pro.)	2mA/μs~6.4A/μs	10mA/μs~32A/μs	20mA/μs~64A/μs
	Slew Rate(Adv.)	2mA/μs~1.6A/μs	10mA/μs~8A/μs	20mA/μs~16A/μs
	Min. Rise Time(Pro.)	20μs(Typical)		
	Min. Rise Time(Adv.)	50μs(Typical)		
	Resolution	2mA/μs	10mA/μs	20mA/μs
	Accuracy	5%±10us		
Measurement				
Voltage	Range	0~80V	0~150V	0~600V
	Resolution	0.5mV	1mV	5mV
	Accuracy	0.015%+0.015%F.S.		
Current	Range	0~160A	0~800A	0~1600A
	Resolution	2mA	10mA	20mA
	Accuracy	0.04%+0.04%F.S.		
Power	Range	0~2200W	0~11000W	0~22000W
	Resolution	100mW	500mW	1000mW
	Accuracy	0.1%+0.1%F.S.		
Sampling Frequency	500kHz			
Protection				
OVP	88V	165V	660V	
OCP	163.2A	816A	1632A	
OPP	2266W	11330W	22660W	
Over Temperature	70~75°C			
Overvoltage Safety Value	110%VF.S.			
Reverse Alarm	Yes			
Alarm Tone	Yes			
Mechanical				
Dimensions(WxHxD)	423.0x577.0x670.0mm			
Package Dimensions(WxHxD)	541.0x861.0x891.0mm			
Unit Weight	129kg			
Shipping Weight	153kg			
AC Input				
Voltage	100~240Vac			
Frequency	50~60Hz			
Power	900VA			
Fuse	10A			

MODEL		EL600VDC24200W		
Rated	Voltage	0~600V		
	Current	0~1760A		
	Power	0~24200W		
	Min. Operating Voltage	0.8V@176A	4V@880A	8V@1760A
Static Mode				
Constant Current Mode	Range	0~176A	0~880A	0~1760A
	Resolution	2mA	10mA	20mA
	Accuracy	0.05%+0.05%F.S.		
Constant Voltage Mode	Range	0~80V	0~150V	0~600V
	Resolution	0.5mV	1mV	5mV
	Accuracy	0.025%+0.025%F.S.		
Constant Power Mode	Range	0~2420W	0~12100W	0~24200W
	Resolution	100mW	500mW	1000mW
	Accuracy	0.2%+0.2%F.S.		
Constant Resistance Mode	Range	13.6mΩ~136Ω(80V)	55mΩ~550Ω(150V)	550mΩ~1100Ω(600V)
	Resolution	13.6mΩ(80V)	55mΩ(150V)	550mΩ(600V)
	Accuracy	Vin/Rset*(0.2%)+0.2% I.F.S.		
Dynamic Mode				
CCD/CRD	T1&T2(Pro.)	0.02ms~300s		
	T1&T2(Adv.)	0.05ms~300s		
	Resolution	1μs		
	Accuracy	1μs+100ppm		
	Slew Rate(Pro.)	2mA/μs~7.04A/μs	10mA/μs~35.2A/μs	20mA/μs~70.4A/μs
	Slew Rate(Adv.)	2mA/μs~1.76A/μs	10mA/μs~8.8A/μs	20mA/μs~17.6A/μs
	Min. Rise Time(Pro.)	20μs(Typical)		
	Min. Rise Time(Adv.)	50μs(Typical)		
	Resolution	2mA/μs	10mA/μs	20mA/μs
	Accuracy	5%±10us		
Measurement				
Voltage	Range	0~80V	0~150V	0~600V
	Resolution	0.5mV	1mV	5mV
	Accuracy	0.015%+0.015%F.S.		
Current	Range	0~176A	0~880A	0~1760A
	Resolution	2mA	10mA	20mA
	Accuracy	0.04%+0.04%F.S.		
Power	Range	0~2420W	0~12100W	0~24200W
	Resolution	100mW	500mW	1000mW
	Accuracy	0.1%+0.1%F.S.		
Sampling Frequency	500kHz			
Protection				
OVP	88V	165V	660V	
OCP	179.52A	897.6A	1795.2A	
OPP	2492.6W	12463W	24926W	
Over Temperature	70~75°C			
Overvoltage Safety Value	110%VF.S.			
Reverse Alarm	Yes			
Alarm Tone	Yes			
Mechanical				
Dimensions(WxHxD)	423.0x577.0x670.0mm			
Package Dimensions(WxHxD)	541.0x861.0x891.0mm			
Unit Weight	134.5kg			
Shipping Weight	158.5kg			
AC Input				
Voltage	100~240Vac			
Frequency	50~60Hz			
Power	900VA			
Fuse	10A			

MODEL		EL600VDC26400W		
Rated	Voltage	0~600V		
	Current	0~1920A		
	Power	0~26400W		
	Min. Operating Voltage	0.8V@192A	4V@960A	8V@1920A
Static Mode				
Constant Current Mode	Range	0~192A	0~960A	0~1920A
	Resolution	2mA	10mA	20mA
	Accuracy	0.05%+0.05%F.S.		
Constant Voltage Mode	Range	0~80V	0~150V	0~600V
	Resolution	0.5mV	1mV	5mV
	Accuracy	0.025%+0.025%F.S.		
Constant Power Mode	Range	0~2640W	0~13200W	0~26400W
	Resolution	100mW	500mW	1000mW
	Accuracy	0.2%+0.2%F.S.		
Constant Resistance Mode	Range	12.5mΩ~125Ω(80V)	50mΩ~500Ω(150V)	500mΩ~1000Ω(600V)
	Resolution	12.5mΩ(80V)	50mΩ(150V)	500mΩ(600V)
	Accuracy	Vin/Rset*(0.2%)+0.2% I.F.S.		
Dynamic Mode				
CCD/CRD	T1&T2(Pro.)	0.02ms~300s		
	T1&T2(Adv.)	0.05ms~300s		
	Resolution	1μs		
	Accuracy	1μs+100ppm		
	Slew Rate(Pro.)	2mA/μs~7.68A/μs	10mA/μs~38.4A/μs	20mA/μs~76.8A/μs
	Slew Rate(Adv.)	2mA/μs~1.92A/μs	10mA/μs~9.6A/μs	20mA/μs~19.2A/μs
	Min. Rise Time(Pro.)	20μs(Typical)		
	Min. Rise Time(Adv.)	50μs(Typical)		
	Resolution	2mA/μs	10mA/μs	20mA/μs
	Accuracy	5%±10us		
Measurement				
Voltage	Range	0~80V	0~150V	0~600V
	Resolution	0.5mV	1mV	5mV
	Accuracy	0.015%+0.015%F.S.		
Current	Range	0~192A	0~960A	0~1920A
	Resolution	2mA	10mA	20mA
	Accuracy	0.04%+0.04%F.S.		
Power	Range	0~2640W	0~13200W	0~26400W
	Resolution	100mW	500mW	1000mW
	Accuracy	0.1%+0.1%F.S.		
Sampling Frequency	500kHz			
Protection				
OVP	88V	165V	660V	
OCP	195.84A	979.2A	1958.4A	
OPP	2719.2W	13596W	27192W	
Over Temperature	70~75°C			
Overvoltage Safety Value	110%VF.S.			
Reverse Alarm	Yes			
Alarm Tone	Yes			
Mechanical				
Dimensions(WxHxD)	423.0x577.0x670.0mm			
Package Dimensions(WxHxD)	541.0x861.0x891.0mm			
Unit Weight	140kg			
Shipping Weight	164kg			
AC Input				
Voltage	100~240Vac			
Frequency	50~60Hz			
Power	900VA			
Fuse	10A			

600V Series System Specifications			
Non Linear Mode			
Range	CL	30uF~5000uF	
	RL	As CR Mode	
	Ls	0.1uH~16uH	
	Rs	30mΩ~20Ω	
Resolution	CL	1uF	
	RL	As CR Mode	
	Ls	0.1uH	
	Rs	1mΩ	
Battery Discharge Mode			
Battery Voltage	As CV Mode		
Current Resolution	As CC Mode		
Record	AH/WH		
Test Time	1s~100000s		
Time Resolution	1s		
Program Mode			
Step No.	300 Max.		
Dwell	0.1ms~4000s		
Spec Check	Voltage/Current/Power		
External Waveform Control/Monitor			
Control/Monitor	Voltage/Current		
Input/Ouput Range	0~10V		
Voltage Range	0~L_range F.S.	0~M_range F.S.	0~H_range F.S.
Current Range	0~L_range F.S.	0~M_range F.S.	0~H_range F.S.
Accuracy	0.4%F.S.		
Resolution	4mV		
Bandwidth	20kHz		
Input Impedance	10kΩ		
Short Circuit			
Current(CC)	Full range current value		
Voltage(CV)	Voltage value at the Max power in working mode		
Resistance(CR)	Min resistance value of CR Mode		
Master/Slave			
Parallel Interface	RJ45		
Parallel Quantity (Pro.)	20 units		
Parallel Quantity (Adv.)	10 units		
General			
Graphic Display	4.3" Color touch LCD		
Operation Key Feature	Soft key, Numeric key, Rotary Knob, USB port for transfer and upgrading firmware		
Rack Mount Handles	Yes		
FAN	Temperature Control		
Interface	RS232/RS485/USB(Standard), GPIB/LAN(Optional)		
Communication Response Time	30ms		
Storage Capacity	User defined settings (300 sets), OCP settings (10 sets), OPP settings (10 sets), Default settings (1 set), Factory setting (1 set)		
Environmental			
Operating Temperature	0~40°C		
Storage Temperature	-20~80°C		
Temperature Coefficient	100ppm/°C(Typical)		
Relative Humidity	10~90%RH		
Altitude	<2000m		
Regulatory Compliance			
Overvoltage Category	II		
Protection Degree	I		
Pollution Degree	II		
Input Impedance	1MΩ(Typical)		
Isolation Voltage	/		
Certificates	CE		

All specifications are subject to change without notice.

MODEL		EL1200VDC1200W		
Rated	Voltage	0~1200V		
	Current	0~45A		
	Power	0~1200W		
	Min. Operating Voltage	2V@4.5A	10V@22.5A	20V@45A
Static Mode				
Constant Current Mode	Range	0~4.5A	0~22.5A	0~45A
	Resolution	0.1mA	0.5mA	1mA
	Accuracy	0.05%+0.05%F.S.		
Constant Voltage Mode	Range	0~150V	0~600V	0~1200V
	Resolution	1mV	5mV	10mV
	Accuracy	0.025%+0.025%F.S.		
Constant Power Mode	Range	0~120W	0~600W	0~1200W
	Resolution	10mW	50mW	100mW
	Accuracy	0.2%+0.2%F.S.		
Constant Resistance Mode	Range	275mΩ~2750Ω(150V)	1100mΩ~11000Ω(600V)	11000mΩ~22000Ω(1200V)
	Resolution	275mΩ(150V)	1100mΩ(600V)	11000mΩ(1200V)
	Accuracy	Vin/Rset*(0.2%)+0.2% I.F.S.		
Dynamic Mode				
CCD/CRD	T1&T2(Pro.)	0.02ms~300s		
	T1&T2(Adv.)	0.05ms~300s		
	Resolution	1μs		
	Accuracy	1μs+100ppm		
	Slew Rate(Pro.)	0.1mA/μs~0.45A/μs	0.5mA/μs~1.575A/μs	1mA/μs~3.15A/μs
	Slew Rate(Adv.)	0.1mA/μs~0.045A/μs	0.5mA/μs~0.225A/μs	1mA/μs~0.45A/μs
	Min. Rise Time(Pro.)	10μs(Typical)		
	Min. Rise Time(Adv.)	50μs(Typical)		
	Resolution	0.1mA/μs	0.5mA/μs	1mA/μs
	Accuracy	5%±10us		
Measurement				
Voltage	Range	0~150V	0~600V	0~1200V
	Resolution	1mV	5mV	10mV
	Accuracy	0.015%+0.015%F.S.		
Current	Range	0~4.5A	0~22.5A	0~45A
	Resolution	0.1mA	0.5mA	1mA
	Accuracy	0.04%+0.06%F.S.		
Power	Range	0~120W	0~600W	0~1200W
	Resolution	10mW	50mW	100mW
	Accuracy	0.1%+0.1%F.S.		
Sampling Frequency	500kHz			
Protection				
OVP	165V	660V	1320V	
OCP	4.59A	22.95A	45.9A	
OPP	123.6W	618W	1236W	
Over Temperature	70~75°C			
Overvoltage Safety Value	110%V.F.S.			
Reverse Alarm	Yes			
Alarm Tone	Yes			
Mechanical				
Dimensions(WxHxD)	423.0x88.0x610.0mm			
Package Dimensions(WxHxD)	665.0x333.0x918.0mm			
Unit Weight	20kg			
Shipping Weight	29kg			
AC Input				
Voltage	100~240Vac			
Frequency	50~60Hz			
Power	150VA			
Fuse	2.5A			

MODEL		EL1200VDC2400W		
Rated	Voltage	0~1200V		
	Current	0~90A		
	Power	0~2400W		
	Min. Operating Voltage	2V@9A	10V@45A	20V@90A
Static Mode				
Constant Current Mode	Range	0~9A	0~45A	0~90A
	Resolution	0.1mA	0.5mA	1mA
	Accuracy	0.05%+0.05%F.S.		
Constant Voltage Mode	Range	0~150V	0~600V	0~1200V
	Resolution	1mV	5mV	10mV
	Accuracy	0.025%+0.025%F.S.		
Constant Power Mode	Range	0~240W	0~1200W	0~2400W
	Resolution	10mW	50mW	100mW
	Accuracy	0.2%+0.2%F.S.		
Constant Resistance Mode	Range	137.5mΩ~1375Ω(150V)	550mΩ~5500Ω(600V)	5500mΩ~11000Ω(1200V)
	Resolution	150mΩ(150V)	600mΩ(600V)	6000mΩ(1200V)
	Accuracy	Vin/Rset*(0.2%)+0.2% I.F.S.		
Dynamic Mode				
CCD/CRD	T1&T2(Pro.)	0.02ms~300s		
	T1&T2(Adv.)	0.05ms~300s		
	Resolution	1μs		
	Accuracy	1μs+100ppm		
	Slew Rate(Pro.)	0.1mA/μs~0.9A/μs	0.5mA/μs~3.15A/μs	1mA/μs~6.3A/μs
	Slew Rate(Adv.)	0.1mA/μs~0.09A/μs	0.5mA/μs~0.45A/μs	1mA/μs~0.9A/μs
	Min. Rise Time(Pro.)	10μs(Typical)		
	Min. Rise Time(Adv.)	50μs(Typical)		
	Resolution	0.1mA/μs	0.5mA/μs	1mA/μs
	Accuracy	5%±10us		
Measurement				
Voltage	Range	0~150V	0~600V	0~1200V
	Resolution	1mV	5mV	10mV
	Accuracy	0.015%+0.015%F.S.		
Current	Range	0~9A	0~45A	0~90A
	Resolution	0.1mA	0.5mA	1mA
	Accuracy	0.04%+0.06%F.S.		
Power	Range	0~240W	0~1200W	0~2400W
	Resolution	10mW	50mW	100mW
	Accuracy	0.1%+0.1%F.S.		
Sampling Frequency	500kHz			
Protection				
OVP	165V	660V	1320V	
OCP	9.18A	45.9A	91.8A	
OPP	247.2W	1236W	2472W	
Over Temperature	70~75°C			
Overvoltage Safety Value	110%VF.S.			
Reverse Alarm	Yes			
Alarm Tone	Yes			
Mechanical				
Dimensions(WxHxD)	423.0x88.0x610.0mm			
Package Dimensions(WxHxD)	665.0x333.0x918.0mm			
Unit Weight	24kg			
Shipping Weight	33kg			
AC Input				
Voltage	100~240Vac			
Frequency	50~60Hz			
Power	180VA			
Fuse	2.5A			

MODEL		EL1200VDC3400W		
Rated	Voltage	0~1200V		
	Current	0~125A		
	Power	0~3400W		
	Min. Operating Voltage	2V@12.5A	10V@62.5A	20V@125A
Static Mode				
Constant Current Mode	Range	0~12.5A	0~62.5A	0~125A
	Resolution	0.2mA	1mA	2mA
	Accuracy	0.05%+0.05%F.S.		
Constant Voltage Mode	Range	0~150V	0~600V	0~1200V
	Resolution	1mV	5mV	10mV
	Accuracy	0.025%+0.025%F.S.		
Constant Power Mode	Range	0~340W	0~1700W	0~3400W
	Resolution	10mW	50mW	100mW
	Accuracy	0.2%+0.2%F.S.		
Constant Resistance Mode	Range	100mΩ~1000Ω(150V)	400mΩ~4000Ω(600V)	4000mΩ~8000Ω(1200V)
	Resolution	100mΩ(150V)	400mΩ(600V)	4000mΩ(1200V)
	Accuracy	Vin/Rset*(0.2%)+0.2% I.F.S.		
Dynamic Mode				
CCD/CRD	T1&T2(Pro.)	0.02ms~300s		
	T1&T2(Adv.)	0.05ms~300s		
	Resolution	1μs		
	Accuracy	1μs+100ppm		
	Slew Rate(Pro.)	0.2mA/μs~0.625A/μs	1mA/μs~3.125A/μs	2mA/μs~6.25A/μs
	Slew Rate(Adv.)	0.2mA/μs~0.125A/μs	1mA/μs~0.625A/μs	2mA/μs~1.25A/μs
	Min. Rise Time(Pro.)	20μs(Typical)		
	Min. Rise Time(Adv.)	50μs(Typical)		
	Resolution	0.2mA/μs	1mA/μs	2mA/μs
	Accuracy	5%±10us		
Measurement				
Voltage	Range	0~150V	0~600V	0~1200V
	Resolution	1mV	5mV	10mV
	Accuracy	0.015%+0.015%F.S.		
Current	Range	0~12.5A	0~62.5A	0~125A
	Resolution	0.2mA	1mA	2mA
	Accuracy	0.04%+0.06%F.S.		
Power	Range	0~340W	0~1700W	0~3400W
	Resolution	10mW	50mW	100mW
	Accuracy	0.1%+0.1%F.S.		
Sampling Frequency	500kHz			
Protection				
OVP	165V	660V	1320V	
OCP	12.75A	63.75A	127.5A	
OPP	350.2W	1751W	3502W	
Over Temperature	70~75°C			
Overvoltage Safety Value	110%V.F.S.			
Reverse Alarm	Yes			
Alarm Tone	Yes			
Mechanical				
Dimensions(WxHxD)	423.0x133.0x610.0mm			
Package Dimensions(WxHxD)	665.0x348.0x918.0mm			
Unit Weight	27kg			
Shipping Weight	36kg			
AC Input				
Voltage	100~240Vac			
Frequency	50~60Hz			
Power	200VA			
Fuse	2.5A			

MODEL		EL1200VDC4400W		
Rated	Voltage	0~1200V		
	Current	0~160A		
	Power	0~4400W		
	Min. Operating Voltage	2V@16A	10V@80A	20V@160A
Static Mode				
Constant Current Mode	Range	0~16A	0~80A	0~160A
	Resolution	0.2mA	1mA	2mA
	Accuracy	0.05%+0.05%F.S.		
Constant Voltage Mode	Range	0~150V	0~600V	0~1200V
	Resolution	1mV	5mV	10mV
	Accuracy	0.025%+0.025%F.S.		
Constant Power Mode	Range	0~440W	0~2200W	0~4400W
	Resolution	10mW	50mW	100mW
	Accuracy	0.2%+0.2%F.S.		
Constant Resistance Mode	Range	75mΩ~750Ω(150V)	300mΩ~3000Ω(600V)	3000mΩ~6000Ω(1200V)
	Resolution	75mΩ(150V)	300mΩ(600V)	3000mΩ(1200V)
	Accuracy	Vin/Rset*(0.2%)+0.2% I.F.S.		
Dynamic Mode				
CCD/CRD	T1&T2(Pro.)	0.02ms~300s		
	T1&T2(Adv.)	0.05ms~300s		
	Resolution	1μs		
	Accuracy	1μs+100ppm		
	Slew Rate(Pro.)	0.2mA/μs~0.8A/μs	1mA/μs~4A/μs	2mA/μs~8A/μs
	Slew Rate(Adv.)	0.2mA/μs~0.16A/μs	1mA/μs~0.8A/μs	2mA/μs~1.6A/μs
	Min. Rise Time(Pro.)	20μs(Typical)		
	Min. Rise Time(Adv.)	50μs(Typical)		
	Resolution	0.2mA/μs	1mA/μs	2mA/μs
	Accuracy	5%±10us		
Measurement				
Voltage	Range	0~150V	0~600V	0~1200V
	Resolution	1mV	5mV	10mV
	Accuracy	0.015%+0.015%F.S.		
Current	Range	0~16A	0~80A	0~160A
	Resolution	0.2mA	1mA	2mA
	Accuracy	0.04%+0.06%F.S.		
Power	Range	0~440W	0~2200W	0~4400W
	Resolution	10mW	50mW	100mW
	Accuracy	0.1%+0.1%F.S.		
Sampling Frequency	500kHz			
Protection				
OVP	165V	660V	1320V	
OCP	16.32A	81.6A	163.2A	
OPP	453.2W	2266W	4532W	
Over Temperature	70~75°C			
Overvoltage Safety Value	110%VF.S.			
Reverse Alarm	Yes			
Alarm Tone	Yes			
Mechanical				
Dimensions(WxHxD)	423.0x133.0x610.0mm			
Package Dimensions(WxHxD)	665.0x348.0x918.0mm			
Unit Weight	28.5kg			
Shipping Weight	37.3kg			
AC Input				
Voltage	100~240Vac			
Frequency	50~60Hz			
Power	200VA			
Fuse	2.5A			

MODEL		EL1200VDC5600W		
Rated	Voltage	0~1200V		
	Current	0~210A		
	Power	0~5600W		
	Min. Operating Voltage	2V@21A	10V@105A	20V@210A
Static Mode				
Constant Current Mode	Range	0~21A	0~105A	0~210A
	Resolution	0.2mA	1mA	2mA
	Accuracy	0.05%+0.05%F.S.		
Constant Voltage Mode	Range	0~150V	0~600V	0~1200V
	Resolution	1mV	5mV	10mV
	Accuracy	0.025%+0.025%F.S.		
Constant Power Mode	Range	0~560W	0~2800W	0~5600W
	Resolution	10mW	50mW	100mW
	Accuracy	0.2%+0.2%F.S.		
Constant Resistance Mode	Range	60mΩ~600Ω(150V)	235mΩ~2300Ω(600V)	2350mΩ~4700Ω(1200V)
	Resolution	60mΩ(150V)	235mΩ(600V)	2350mΩ(1200V)
	Accuracy	Vin/Rset*(0.2%)+0.2% I.F.S.		
Dynamic Mode				
CCD/CRD	T1&T2(Pro.)	0.02ms~300s		
	T1&T2(Adv.)	0.05ms~300s		
	Resolution	1μs		
	Accuracy	1μs+100ppm		
	Slew Rate(Pro.)	0.2mA/μs~1.05A/μs	1mA/μs~5.25A/μs	2mA/μs~10.5A/μs
	Slew Rate(Adv.)	0.2mA/μs~0.21A/μs	1mA/μs~1.05A/μs	2mA/μs~2.1A/μs
	Min. Rise Time(Pro.)	20μs(Typical)		
	Min. Rise Time(Adv.)	50μs(Typical)		
	Resolution	0.2mA/μs	1mA/μs	2mA/μs
	Accuracy	5%±10us		
Measurement				
Voltage	Range	0~150V	0~600V	0~1200V
	Resolution	1mV	5mV	10mV
	Accuracy	0.015%+0.015%F.S.		
Current	Range	0~21A	0~105A	0~210A
	Resolution	0.2mA	1mA	2mA
	Accuracy	0.04%+0.06%F.S.		
Power	Range	0~560W	0~2800W	0~5600W
	Resolution	10mW	50mW	100mW
	Accuracy	0.1%+0.1%F.S.		
Sampling Frequency	500kHz			
Protection				
OVP	165V	660V	1320V	
OCP	21.42A	107.1A	214.2A	
OPP	576.8W	2884W	5768W	
Over Temperature	70~75°C			
Overvoltage Safety Value	110%VF.S.			
Reverse Alarm	Yes			
Alarm Tone	Yes			
Mechanical				
Dimensions(WxHxD)	423.0x133.0x610.0mm			
Package Dimensions(WxHxD)	665.0x348.0x918.0mm			
Unit Weight	32.5kg			
Shipping Weight	41.3kg			
AC Input				
Voltage	100~240Vac			
Frequency	50~60Hz			
Power	200VA			
Fuse	2.5A			

MODEL		EL1200VDC6600W		
Rated	Voltage	0~1200V		
	Current	0~240A		
	Power	0~6600W		
	Min. Operating Voltage	2V@24A	10V@120A	20V@240A
Static Mode				
Constant Current Mode	Range	0~24A	0~120A	0~240A
	Resolution	0.2mA	1mA	2mA
	Accuracy	0.05%+0.05%F.S.		
Constant Voltage Mode	Range	0~150V	0~600V	0~1200V
	Resolution	1mV	5mV	10mV
	Accuracy	0.025%+0.025%F.S.		
Constant Power Mode	Range	0~660W	0~3300W	0~6600W
	Resolution	10mW	50mW	100mW
	Accuracy	0.2%+0.2%F.S.		
Constant Resistance Mode	Range	50mΩ~500Ω(150V)	200mΩ~2000Ω(600V)	2000mΩ~4000Ω(1200V)
	Resolution	50mΩ(150V)	200mΩ(600V)	2000mΩ(1200V)
	Accuracy	Vin/Rset*(0.2%)+0.2% I.F.S.		
Dynamic Mode				
CCD/CRD	T1&T2(Pro.)	0.02ms~300s		
	T1&T2(Adv.)	0.05ms~300s		
	Resolution	1μs		
	Accuracy	1μs+100ppm		
	Slew Rate(Pro.)	0.2mA/μs~1.2A/μs	1mA/μs~6A/μs	2mA/μs~12A/μs
	Slew Rate(Adv.)	0.2mA/μs~0.24A/μs	1mA/μs~1.2A/μs	2mA/μs~2.4A/μs
	Min. Rise Time(Pro.)	20μs(Typical)		
	Min. Rise Time(Adv.)	50μs(Typical)		
	Resolution	0.2mA/μs	1mA/μs	2mA/μs
	Accuracy	5%±10us		
Measurement				
Voltage	Range	0~150V	0~600V	0~1200V
	Resolution	1mV	5mV	10mV
	Accuracy	0.015%+0.015%F.S.		
Current	Range	0~24A	0~120A	0~240A
	Resolution	0.2mA	1mA	2mA
	Accuracy	0.04%+0.06%F.S.		
Power	Range	0~660W	0~3300W	0~6600W
	Resolution	10mW	50mW	100mW
	Accuracy	0.1%+0.1%F.S.		
Sampling Frequency	500kHz			
Protection				
OVP	165V	660V	1320V	
OCP	24.48A	122.4A	244.8A	
OPP	679.8W	3399W	6798W	
Over Temperature	70~75°C			
Overvoltage Safety Value	110%VF.S.			
Reverse Alarm	Yes			
Alarm Tone	Yes			
Mechanical				
Dimensions(WxHxD)	423.0x177.0x610.0mm			
Package Dimensions(WxHxD)	665.0x392.0x918.0mm			
Unit Weight	38kg			
Shipping Weight	47kg			
AC Input				
Voltage	100~240Vac			
Frequency	50~60Hz			
Power	250VA			
Fuse	3.15A			

MODEL		EL1200VDC8800W		
Rated	Voltage	0~1200V		
	Current	0~320A		
	Power	0~8800W		
	Min. Operating Voltage	2V@32A	10V@160A	20V@320A
Static Mode				
Constant Current Mode	Range	0~32A	0~160A	0~320A
	Resolution	0.4mA	2mA	4mA
	Accuracy	0.05%+0.05%F.S.		
Constant Voltage Mode	Range	0~150V	0~600V	0~1200V
	Resolution	1mV	5mV	10mV
	Accuracy	0.025%+0.025%F.S.		
Constant Power Mode	Range	0~880W	0~4400W	0~8800W
	Resolution	20mW	100mW	200mW
	Accuracy	0.2%+0.2%F.S.		
Constant Resistance Mode	Range	37.5mΩ~375Ω(150V)	150mΩ~1500Ω(600V)	1500mΩ~3000Ω(1200V)
	Resolution	37.5mΩ(150V)	150mΩ(600V)	1500mΩ(1200V)
	Accuracy	Vin/Rset*(0.2%)+0.2% I.F.S.		
Dynamic Mode				
CCD/CRD	T1&T2(Pro.)	0.02ms~300s		
	T1&T2(Adv.)	0.05ms~300s		
	Resolution	1μs		
	Accuracy	1μs+100ppm		
	Slew Rate(Pro.)	0.4mA/μs~1.28A/μs	2mA/μs~6.4A/μs	4mA/μs~12.8A/μs
	Slew Rate(Adv.)	0.4mA/μs~0.32A/μs	2mA/μs~1.6A/μs	4mA/μs~3.2A/μs
	Min. Rise Time(Pro.)	20μs(Typical)		
	Min. Rise Time(Adv.)	50μs(Typical)		
	Resolution	0.4mA/μs	2mA/μs	4mA/μs
	Accuracy	5%±10us		
Measurement				
Voltage	Range	0~150V	0~600V	0~1200V
	Resolution	1mV	5mV	10mV
	Accuracy	0.015%+0.015%F.S.		
Current	Range	0~32A	0~160A	0~320A
	Resolution	0.4mA	2mA	4mA
	Accuracy	0.04%+0.06%F.S.		
Power	Range	0~880W	0~4400W	0~8800W
	Resolution	20mW	100mW	200mW
	Accuracy	0.1%+0.1%F.S.		
Sampling Frequency	500kHz			
Protection				
OVP	165V	660V	1320V	
OCP	32.64A	163.2A	326.4A	
OPP	906.4W	4532W	9064W	
Over Temperature	70~75°C			
Overvoltage Safety Value	110%VF.S.			
Reverse Alarm	Yes			
Alarm Tone	Yes			
Mechanical				
Dimensions(WxHxD)	423.0x311.0x670.0mm			
Package Dimensions(WxHxD)	541.0x591.0x891.0mm			
Unit Weight	61.5kg			
Shipping Weight	81.5kg			
AC Input				
Voltage	100~240Vac			
Frequency	50~60Hz			
Power	450VA			
Fuse	5A			

MODEL		EL1200VDC11000W		
Rated	Voltage	0~1200V		
	Current	0~400A		
	Power	0~11000W		
	Min. Operating Voltage	2V@40A	10V@200A	20V@400A
Static Mode				
Constant Current Mode	Range	0~40A	0~200A	0~400A
	Resolution	0.4mA	2mA	4mA
	Accuracy	0.05%+0.05%F.S.		
Constant Voltage Mode	Range	0~150V	0~600V	0~1200V
	Resolution	1mV	5mV	10mV
	Accuracy	0.025%+0.025%F.S.		
Constant Power Mode	Range	0~1100W	0~5500W	0~11000W
	Resolution	20mW	100mW	200mW
	Accuracy	0.2%+0.2%F.S.		
Constant Resistance Mode	Range	30mΩ~300Ω(150V)	120mΩ~1200Ω(600V)	1200mΩ~2400Ω(1200V)
	Resolution	30mΩ(150V)	120mΩ(600V)	1200mΩ(1200V)
	Accuracy	Vin/Rset*(0.2%)+0.2% I.F.S.		
Dynamic Mode				
CCD/CRD	T1&T2(Pro.)	0.02ms~300s		
	T1&T2(Adv.)	0.05ms~300s		
	Resolution	1μs		
	Accuracy	1μs+100ppm		
	Slew Rate(Pro.)	0.4mA/μs~1.6A/μs	2mA/μs~8A/μs	4mA/μs~16A/μs
	Slew Rate(Adv.)	0.4mA/μs~0.4A/μs	2mA/μs~2A/μs	4mA/μs~4A/μs
	Min. Rise Time(Pro.)	20μs(Typical)		
	Min. Rise Time(Adv.)	50μs(Typical)		
	Resolution	0.4mA/μs	2mA/μs	4mA/μs
	Accuracy	5%±10us		
Measurement				
Voltage	Range	0~150V	0~600V	0~1200V
	Resolution	1mV	5mV	10mV
	Accuracy	0.015%+0.015%F.S.		
Current	Range	0~40A	0~200A	0~400A
	Resolution	0.4mA	2mA	4mA
	Accuracy	0.04%+0.06%F.S.		
Power	Range	0~1100W	0~5500W	0~11000W
	Resolution	20mW	100mW	200mW
	Accuracy	0.1%+0.1%F.S.		
Sampling Frequency	500kHz			
Protection				
OVP	165V	660V	1320V	
OCP	40.8A	204A	408A	
OPP	1133W	5665W	11330W	
Over Temperature	70~75°C			
Overvoltage Safety Value	110%VF.S.			
Reverse Alarm	Yes			
Alarm Tone	Yes			
Mechanical				
Dimensions(WxHxD)	423.0x311.0x670.0mm			
Package Dimensions(WxHxD)	541.0x591.0x891.0mm			
Unit Weight	67kg			
Shipping Weight	87kg			
AC Input				
Voltage	100~240Vac			
Frequency	50~60Hz			
Power	450VA			
Fuse	5A			

MODEL		EL1200VDC13200W		
Rated	Voltage	0~1200V		
	Current	0~480A		
	Power	0~13200W		
	Min. Operating Voltage	2V@48A	10V@240A	20V@480A
Static Mode				
Constant Current Mode	Range	0~48A	0~240A	0~480A
	Resolution	0.4mA	2mA	4mA
	Accuracy	0.05%+0.05%F.S.		
Constant Voltage Mode	Range	0~150V	0~600V	0~1200V
	Resolution	1mV	5mV	10mV
	Accuracy	0.025%+0.025%F.S.		
Constant Power Mode	Range	0~1320W	0~6600W	0~13200W
	Resolution	40mW	200mW	400mW
	Accuracy	0.2%+0.2%F.S.		
Constant Resistance Mode	Range	25mΩ~250Ω(150V)	100mΩ~1000Ω(600V)	1000mΩ~2000Ω(1200V)
	Resolution	25mΩ(150V)	100mΩ(600V)	1000mΩ(1200V)
	Accuracy	Vin/Rset*(0.2%)+0.2% I.F.S.		
Dynamic Mode				
CCD/CRD	T1&T2(Pro.)	0.02ms~300s		
	T1&T2(Adv.)	0.05ms~300s		
	Resolution	1μs		
	Accuracy	1μs+100ppm		
	Slew Rate(Pro.)	0.4mA/μs~1.6A/μs	2mA/μs~8A/μs	4mA/μs~16A/μs
	Slew Rate(Adv.)	0.4mA/μs~0.48A/μs	2mA/μs~2.4A/μs	4mA/μs~4.8A/μs
	Min. Rise Time(Pro.)	20μs(Typical)		
	Min. Rise Time(Adv.)	50μs(Typical)		
	Resolution	0.4mA/μs	2mA/μs	4mA/μs
	Accuracy	5%±10us		
Measurement				
Voltage	Range	0~150V	0~600V	0~1200V
	Resolution	1mV	5mV	10mV
	Accuracy	0.015%+0.015%F.S.		
Current	Range	0~48A	0~240A	0~480A
	Resolution	0.4mA	2mA	4mA
	Accuracy	0.04%+0.06%F.S.		
Power	Range	0~1320W	0~6600W	0~13200W
	Resolution	40mW	200mW	400mW
	Accuracy	0.1%+0.1%F.S.		
Sampling Frequency	500kHz			
Protection				
OVP	165V	660V	1320V	
OCP	48.96A	244.8A	489.6A	
OPP	1359.6W	6798W	13596W	
Over Temperature	70~75°C			
Overvoltage Safety Value	110%VF.S.			
Reverse Alarm	Yes			
Alarm Tone	Yes			
Mechanical				
Dimensions(WxHxD)	423.0x311.0x670.0mm			
Package Dimensions(WxHxD)	541.0x591.0x891.0mm			
Unit Weight	72.5kg			
Shipping Weight	92.5kg			
AC Input				
Voltage	100~240Vac			
Frequency	50~60Hz			
Power	450VA			
Fuse	5A			

MODEL		EL1200VDC15400W		
Rated	Voltage	0~1200V		
	Current	0~560A		
	Power	0~15400W		
	Min. Operating Voltage	2V@56A	10V@280A	20V@560A
Static Mode				
Constant Current Mode	Range	0~56A	0~280A	0~560A
	Resolution	0.5mA	2mA	5mA
	Accuracy	0.05%+0.05%F.S.		
Constant Voltage Mode	Range	0~150V	0~600V	0~1200V
	Resolution	1mV	5mV	10mV
	Accuracy	0.025%+0.025%F.S.		
Constant Power Mode	Range	0~1540W	0~7700W	0~15400W
	Resolution	40mW	200mW	400mW
	Accuracy	0.2%+0.2%F.S.		
Constant Resistance Mode	Range	21mΩ~210Ω(150V)	85mΩ~850Ω(600V)	850mΩ~1700Ω(1200V)
	Resolution	21mΩ(150V)	85mΩ(600V)	850mΩ(1200V)
	Accuracy	Vin/Rset*(0.2%)+0.2% I.F.S.		
Dynamic Mode				
CCD/CRD	T1&T2(Pro.)	0.02ms~300s		
	T1&T2(Adv.)	0.05ms~300s		
	Resolution	1μs		
	Accuracy	1μs+100ppm		
	Slew Rate(Pro.)	0.5mA/μs~1.87A/μs	2mA/μs~9.3A/μs	5mA/μs~18.7A/μs
	Slew Rate(Adv.)	0.5mA/μs~0.56A/μs	2mA/μs~2.8A/μs	5mA/μs~5.6A/μs
	Min. Rise Time(Pro.)	20μs(Typical)		
	Min. Rise Time(Adv.)	50μs(Typical)		
	Resolution	0.5mA/μs	2mA/μs	5mA/μs
	Accuracy	5%±10us		
Measurement				
Voltage	Range	0~150V	0~600V	0~1200V
	Resolution	1mV	5mV	10mV
	Accuracy	0.015%+0.015%F.S.		
Current	Range	0~56A	0~280A	0~560A
	Resolution	0.5mA	2mA	5mA
	Accuracy	0.04%+0.06%F.S.		
Power	Range	0~1540W	0~7700W	0~15400W
	Resolution	40mW	200mW	400mW
	Accuracy	0.1%+0.1%F.S.		
Sampling Frequency	500kHz			
Protection				
OVP	165V	660V	1320V	
OCP	57.12A	285.6A	571.2A	
OPP	1586.2W	7931W	15862W	
Over Temperature	70~75°C			
Overvoltage Safety Value	110%VF.S.			
Reverse Alarm	Yes			
Alarm Tone	Yes			
Mechanical				
Dimensions(WxHxD)	423.0x444.0x670.0mm			
Package Dimensions(WxHxD)	544.0x741.0x891.0mm			
Unit Weight	94.5kg			
Shipping Weight	116.5kg			
AC Input				
Voltage	100~240Vac			
Frequency	50~60Hz			
Power	700VA			
Fuse	8A			

MODEL		EL1200VDC17600W		
Rated	Voltage	0~1200V		
	Current	0~640A		
	Power	0~17600W		
	Min. Operating Voltage	2V@64A	10V@320A	20V@640A
Static Mode				
Constant Current Mode	Range	0~64A	0~320A	0~640A
	Resolution	0.5mA	2mA	5mA
	Accuracy	0.05%+0.05%F.S.		
Constant Voltage Mode	Range	0~150V	0~600V	0~1200V
	Resolution	1mV	5mV	10mV
	Accuracy	0.025%+0.025%F.S.		
Constant Power Mode	Range	0~1760W	0~8800W	0~17600W
	Resolution	100mW	500mW	1000mW
	Accuracy	0.2%+0.2%F.S.		
Constant Resistance Mode	Range	18.7mΩ~187Ω(150V)	75mΩ~750Ω(600V)	750mΩ~1500Ω(1200V)
	Resolution	18.7mΩ(150V)	75mΩ(600V)	750mΩ(1200V)
	Accuracy	Vin/Rset*(0.2%)+0.2% I.F.S.		
Dynamic Mode				
CCD/CRD	T1&T2(Pro.)	0.02ms~300s		
	T1&T2(Adv.)	0.05ms~300s		
	Resolution	1μs		
	Accuracy	1μs+100ppm		
	Slew Rate(Pro.)	0.5mA/μs~2.1A/μs	2mA/μs~10.7A/μs	5mA/μs~21.3A/μs
	Slew Rate(Adv.)	0.5mA/μs~0.64A/μs	2mA/μs~3.2A/μs	5mA/μs~6.4A/μs
	Min. Rise Time(Pro.)	20μs(Typical)		
	Min. Rise Time(Adv.)	50μs(Typical)		
	Resolution	0.5mA/μs	2mA/μs	5mA/μs
	Accuracy	5%±10us		
Measurement				
Voltage	Range	0~150V	0~600V	0~1200V
	Resolution	1mV	5mV	10mV
	Accuracy	0.015%+0.015%F.S.		
Current	Range	0~64A	0~320A	0~640A
	Resolution	0.5mA	2mA	5mA
	Accuracy	0.04%+0.06%F.S.		
Power	Range	0~1760W	0~8800W	0~17600W
	Resolution	100mW	500mW	1000mW
	Accuracy	0.1%+0.1%F.S.		
Sampling Frequency	500kHz			
Protection				
OVP	165V	660V	1320V	
OCP	65.28A	326.4A	652.8A	
OPP	1812.8W	9064W	18128W	
Over Temperature	70~75°C			
Overvoltage Safety Value	110%VF.S.			
Reverse Alarm	Yes			
Alarm Tone	Yes			
Mechanical				
Dimensions(WxHxD)	423.0x444.0x670.0mm			
Package Dimensions(WxHxD)	544.0x741.0x891.0mm			
Unit Weight	100kg			
Shipping Weight	122kg			
AC Input				
Voltage	100~240Vac			
Frequency	50~60Hz			
Power	700VA			
Fuse	8A			

MODEL		EL1200VDC19800W		
Rated	Voltage	0~1200V		
	Current	0~720A		
	Power	0~19800W		
	Min. Operating Voltage	2V@72A	10V@360A	20V@720A
Static Mode				
Constant Current Mode	Range	0~72A	0~360A	0~720A
	Resolution	0.5mA	2mA	5mA
	Accuracy	0.05%+0.05%F.S.		
Constant Voltage Mode	Range	0~150V	0~600V	0~1200V
	Resolution	1mV	5mV	10mV
	Accuracy	0.025%+0.025%F.S.		
Constant Power Mode	Range	0~1980W	0~9900W	0~19800W
	Resolution	100mW	500mW	1000mW
	Accuracy	0.2%+0.2%F.S.		
Constant Resistance Mode	Range	16.7mΩ~166.7Ω(150V)	66.7mΩ~666Ω(600V)	666.7mΩ~1333Ω(1200V)
	Resolution	16.7mΩ(150V)	66.7mΩ(600V)	666.7mΩ(1200V)
	Accuracy	Vin/Rset*(0.2%)+0.2% I.F.S.		
Dynamic Mode				
CCD/CRD	T1&T2(Pro.)	0.02ms~300s		
	T1&T2(Adv.)	0.05ms~300s		
	Resolution	1μs		
	Accuracy	1μs+100ppm		
	Slew Rate(Pro.)	0.5mA/μs~2.4A/μs	2mA/μs~12A/μs	5mA/μs~24A/μs
	Slew Rate(Adv.)	0.5mA/μs~0.72A/μs	2mA/μs~3.6A/μs	5mA/μs~7.2A/μs
	Min. Rise Time(Pro.)	20μs(Typical)		
	Min. Rise Time(Adv.)	50μs(Typical)		
	Resolution	0.5mA/μs	2mA/μs	5mA/μs
	Accuracy	5%±10us		
Measurement				
Voltage	Range	0~150V	0~600V	0~1200V
	Resolution	1mV	5mV	10mV
	Accuracy	0.015%+0.015%F.S.		
Current	Range	0~72A	0~360A	0~720A
	Resolution	0.5mA	2mA	5mA
	Accuracy	0.04%+0.06%F.S.		
Power	Range	0~1980W	0~9900W	0~19800W
	Resolution	100mW	500mW	1000mW
	Accuracy	0.1%+0.1%F.S.		
Sampling Frequency	500kHz			
Protection				
OVP	165V	660V	1320V	
OCP	73.44A	367.2A	734.4A	
OPP	2039.4W	10197W	20394W	
Over Temperature	70~75°C			
Overvoltage Safety Value	110%VF.S.			
Reverse Alarm	Yes			
Alarm Tone	Yes			
Mechanical				
Dimensions(WxHxD)	423.0x444.0x670.0mm			
Package Dimensions(WxHxD)	544.0x741.0x891.0mm			
Unit Weight	105.5kg			
Shipping Weight	127.5kg			
AC Input				
Voltage	100~240Vac			
Frequency	50~60Hz			
Power	700VA			
Fuse	8A			

MODEL		EL1200VDC22000W		
Rated	Voltage	0~1200V		
	Current	0~800A		
	Power	0~22000W		
	Min. Operating Voltage	2V@80A	10V@400A	20V@800A
Static Mode				
Constant Current Mode	Range	0~80A	0~400A	0~800A
	Resolution	1mA	5mA	10mA
	Accuracy	0.05%+0.05%F.S.		
Constant Voltage Mode	Range	0~150V	0~600V	0~1200V
	Resolution	1mV	5mV	10mV
	Accuracy	0.025%+0.025%F.S.		
Constant Power Mode	Range	0~2200W	0~11000W	0~22000W
	Resolution	100mW	500mW	1000mW
	Accuracy	0.2%+0.2%F.S.		
Constant Resistance Mode	Range	15mΩ~150Ω(150V)	60mΩ~600Ω(600V)	600mΩ~1200Ω(1200V)
	Resolution	15mΩ(150V)	60mΩ(600V)	600mΩ(1200V)
	Accuracy	Vin/Rset*(0.2%)+0.2% I.F.S.		
Dynamic Mode				
CCD/CRD	T1&T2(Pro.)	0.02ms~300s		
	T1&T2(Adv.)	0.05ms~300s		
	Resolution	1μs		
	Accuracy	1μs+100ppm		
	Slew Rate(Pro.)	1mA/μs~2.7A/μs	5mA/μs~13.3A/μs	10mA/μs~26.7A/μs
	Slew Rate(Adv.)	1mA/μs~0.8A/μs	5mA/μs~4A/μs	10mA/μs~8A/μs
	Min. Rise Time(Pro.)	20μs(Typical)		
	Min. Rise Time(Adv.)	50μs(Typical)		
	Resolution	1mA/μs	5mA/μs	10mA/μs
	Accuracy	5%±10us		
Measurement				
Voltage	Range	0~150V	0~600V	0~1200V
	Resolution	1mV	5mV	10mV
	Accuracy	0.015%+0.015%F.S.		
Current	Range	0~80A	0~400A	0~800A
	Resolution	1mA	5mA	10mA
	Accuracy	0.04%+0.06%F.S.		
Power	Range	0~2200W	0~11000W	0~22000W
	Resolution	100mW	500mW	1000mW
	Accuracy	0.1%+0.1%F.S.		
Sampling Frequency	500kHz			
Protection				
OVP	165V	660V	1320V	
OCP	81.6A	408A	816A	
OPP	2266W	11330W	22660W	
Over Temperature	70-75°C			
Overvoltage Safety Value	110%VF.S.			
Reverse Alarm	Yes			
Alarm Tone	Yes			
Mechanical				
Dimensions(WxHxD)	423.0x577.0x670.0mm			
Package Dimensions(WxHxD)	541.0x861.0x891.0mm			
Unit Weight	129kg			
Shipping Weight	153kg			
AC Input				
Voltage	100~240Vac			
Frequency	50~60Hz			
Power	900VA			
Fuse	10A			

MODEL		EL1200VDC24200W		
Rated	Voltage	0~1200V		
	Current	0~880A		
	Power	0~24200W		
	Min. Operating Voltage	2V@88A	10V@440A	20V@880A
Static Mode				
Constant Current Mode	Range	0~88A	0~440A	0~880A
	Resolution	1mA	5mA	10mA
	Accuracy	0.05%+0.05%F.S.		
Constant Voltage Mode	Range	0~150V	0~600V	0~1200V
	Resolution	1mV	5mV	10mV
	Accuracy	0.025%+0.025%F.S.		
Constant Power Mode	Range	0~2420W	0~12100W	0~24200W
	Resolution	100mW	500mW	1000mW
	Accuracy	0.2%+0.2%F.S.		
Constant Resistance Mode	Range	13.6mΩ~136Ω(150V)	55mΩ~550Ω(600V)	550mΩ~1100Ω(1200V)
	Resolution	13.6mΩ(150V)	55mΩ(600V)	550mΩ(1200V)
	Accuracy	Vin/Rset*(0.2%)+0.2% I.F.S.		
Dynamic Mode				
CCD/CRD	T1&T2(Pro.)	0.02ms~300s		
	T1&T2(Adv.)	0.05ms~300s		
	Resolution	1μs		
	Accuracy	1μs+100ppm		
	Slew Rate(Pro.)	1mA/μs~2.93A/μs	5mA/μs~14.7A/μs	10mA/μs~29.3A/μs
	Slew Rate(Adv.)	1mA/μs~0.88A/μs	5mA/μs~4.4A/μs	10mA/μs~8.8A/μs
	Min. Rise Time(Pro.)	20μs(Typical)		
	Min. Rise Time(Adv.)	50μs(Typical)		
	Resolution	1mA/μs	5mA/μs	10mA/μs
	Accuracy	5%±10us		
Measurement				
Voltage	Range	0~150V	0~600V	0~1200V
	Resolution	1mV	5mV	10mV
	Accuracy	0.015%+0.015%F.S.		
Current	Range	0~88A	0~440A	0~880A
	Resolution	1mA	5mA	10mA
	Accuracy	0.04%+0.06%F.S.		
Power	Range	0~2420W	0~12100W	0~24200W
	Resolution	100mW	500mW	1000mW
	Accuracy	0.1%+0.1%F.S.		
Sampling Frequency	500kHz			
Protection				
OVP	165V	660V	1320V	
OCP	89.76A	448.8A	897.6A	
OPP	2492.6W	12463W	24926W	
Over Temperature	70~75°C			
Overvoltage Safety Value	110%VF.S.			
Reverse Alarm	Yes			
Alarm Tone	Yes			
Mechanical				
Dimensions(WxHxD)	423.0x577.0x670.0mm			
Package Dimensions(WxHxD)	541.0x861.0x891.0mm			
Unit Weight	134.5kg			
Shipping Weight	158.5kg			
AC Input				
Voltage	100~240Vac			
Frequency	50~60Hz			
Power	900VA			
Fuse	10A			

MODEL		EL1200VDC26400W		
Rated	Voltage	0~1200V		
	Current	0~960A		
	Power	0~26400W		
	Min. Operating Voltage	2V@96A	10V@480A	20V@960A
Static Mode				
Constant Current Mode	Range	0~96A	0~480A	0~960A
	Resolution	1mA	5mA	10mA
	Accuracy	0.05%+0.05%F.S.		
Constant Voltage Mode	Range	0~150V	0~600V	0~1200V
	Resolution	1mV	5mV	10mV
	Accuracy	0.025%+0.025%F.S.		
Constant Power Mode	Range	0~2640W	0~13200W	0~26400W
	Resolution	100mW	500mW	1000mW
	Accuracy	0.2%+0.2%F.S.		
Constant Resistance Mode	Range	12.5mΩ~125Ω(150V)	50mΩ~500Ω(600V)	500mΩ~1000Ω(1200V)
	Resolution	12.5mΩ(150V)	50mΩ(600V)	500mΩ(1200V)
	Accuracy	Vin/Rset*(0.2%)+0.2% I.F.S.		
Dynamic Mode				
CCD/CRD	T1&T2(Pro.)	0.02ms~300s		
	T1&T2(Adv.)	0.05ms~300s		
	Resolution	1μs		
	Accuracy	1μs+100ppm		
	Slew Rate(Pro.)	1mA/μs~3.2A/μs	5mA/μs~16A/μs	10mA/μs~32A/μs
	Slew Rate(Adv.)	1mA/μs~0.96A/μs	5mA/μs~4.8A/μs	10mA/μs~9.6A/μs
	Min. Rise Time(Pro.)	20μs(Typical)		
	Min. Rise Time(Adv.)	50μs(Typical)		
	Resolution	1mA/μs	5mA/μs	10mA/μs
	Accuracy	5%±10us		
Measurement				
Voltage	Range	0~150V	0~600V	0~1200V
	Resolution	1mV	5mV	10mV
	Accuracy	0.015%+0.015%F.S.		
Current	Range	0~96A	0~480A	0~960A
	Resolution	1mA	5mA	10mA
	Accuracy	0.04%+0.06%F.S.		
Power	Range	0~2640W	0~13200W	0~26400W
	Resolution	100mW	500mW	1000mW
	Accuracy	0.1%+0.1%F.S.		
Sampling Frequency	500kHz			
Protection				
OVP	165V	660V	1320V	
OCP	97.92A	489.6A	979.2A	
OPP	2719.2W	13596W	27192W	
Over Temperature	70~75°C			
Overvoltage Safety Value	110%VF.S.			
Reverse Alarm	Yes			
Alarm Tone	Yes			
Mechanical				
Dimensions(WxHxD)	423.0x577.0x670.0mm			
Package Dimensions(WxHxD)	541.0x861.0x891.0mm			
Unit Weight	140kg			
Shipping Weight	164kg			
AC Input				
Voltage	100~240Vac			
Frequency	50~60Hz			
Power	900VA			
Fuse	10A			

1200V Series System Specifications			
Non Linear Mode			
Range	CL	30uF~5000uF	
	RL	As CR Mode	
	Ls	0.1uH~16uH	
	Rs	30mΩ~20Ω	
Resolution	CL	1uF	
	RL	As CR Mode	
	Ls	0.1uH	
	Rs	1mΩ	
Battery Discharge Mode			
Battery Voltage	As CV Mode		
Current Resolution	As CC Mode		
Record	AH/WH		
Test Time	1s~100000s		
Time Resolution	1s		
Program Mode			
Step No.	300 Max.		
Dwell	0.1ms~4000s		
Spec Check	Voltage/Current/Power		
External Waveform Control/Monitor			
Control/Monitor	Voltage/Current		
Input/Output Range	0~10V		
Voltage Range	0~L_range F.S.	0~M_range F.S.	0~H_range F.S.
Current Range	0~L_range F.S.	0~M_range F.S.	0~H_range F.S.
Accuracy	0.4%F.S.		
Resolution	4mV		
Bandwidth	20kHz		
Input Impedance	10kΩ		
Short Circuit			
Current(CC)	Full range current value		
Voltage(CV)	Voltage value at the Max power in working mode		
Resistance(CR)	Min resistance value of CR Mode		
Master/Slave			
Parallel Interface	RJ45		
Parallel Quantity (Pro.)	20 units		
Parallel Quantity (Adv.)	10 units		
General			
Graphic Display	4.3" Color touch LCD		
Operation Key Feature	Soft key, Numeric key, Rotary Knob, USB port for transfer and upgrading firmware		
Rack Mount Handles	Yes		
FAN	Temperature Control		
Interface	RS232/RS485/USB(Standard), GPIB/LAN(Optional)		
Communication Response Time	30ms		
Storage Capacity	User defined settings (300 sets), OCP settings (10 sets), OPP settings (10 sets), Default settings (1 set), Factory setting (1 set)		
Environmental			
Operating Temperature	0~40°C		
Storage Temperature	-20~80°C		
Temperature Coefficient	100ppm/°C(Typical)		
Relative Humidity	10~90%RH		
Altitude	≤2000m		
Regulatory Compliance			
Overvoltage Category	II		
Protection Degree	I		
Pollution Degree	II		
Input Impedance	2MΩ(Typical)		
Isolation Voltage	/		
Certificates	CE		

All specifications are subject to change without notice.

Notice:

1. Each model size indicated here does not include the wheel and the protective cover.
2. Minimum rise time is valid only for loading current > 5%F.S.
3. The measured noise is 79dB which is tested under the condition of 40°C ambient temperature with full power for 5 minutes and 1 meter away from the rear panel.
4. If the operating voltage exceeds the rated voltage for 1.1 times, it will cause permanent damage to the unit.
5. The over temperature protection sampling point is located in the vent.
6. The power rating specifications of 1200V models as below.

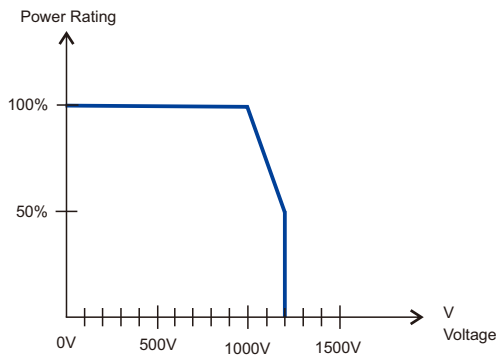

7. All the specifications are tested at temperature of 25°C, unless otherwise noted.
See the diagram below for power derating.

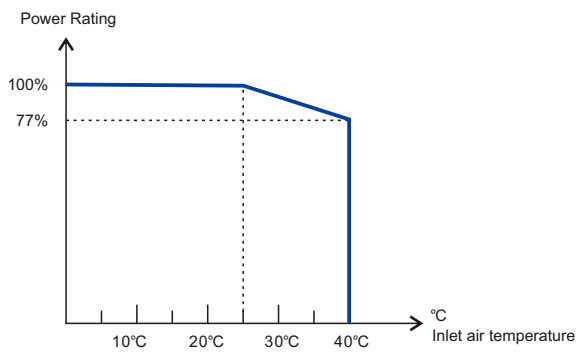

Appendix B Warranty

Thank you for purchasing the High Power DC Load of APM Technologies (referred to hereafter as “APM”). In order for you to use our products properly, APM provides you with the standard warranty service as stipulated below. Please read the following instructions carefully.

This warranty is applicable to the High Power DC Load of APM.

All quality warranties and services offered by your distributors are not subject to or covered by this warranty card. Our company bears no responsibility for honoring any commitment or warranty in the aspect for quality warranty or services made by the distributors.

Warranty Period

1. The warranty period of APM High Power DC Load is 1 (one) year, or refer to relevant Distributor Agreement terms.
2. The warranty period will not be extended or recalculated after a product or component replacement; repaired or replaced products are covered for the remainder of the original warranty period and subject to the conditions outlined in the original warranty.

Warranty Terms

1. In case of product malfunction within the warranty period, please send both the scanned copy of warranty card and purchasing invoice to the APM Customer Service by email. APM will provide you services for maintenance and replacement of defected product or components according to the actual conditions. Whatever method we may adopt, APM always strives to provide you with the highest standard and utmost professional after-sales services.
2. In case of product replacement, all replaced or exchanged parts which are removed under this warranty will become the property of APM. Please return the replaced product and components to the original place of purchase for APM to collect the replaced items in a certain period of time.

Liability Waiver

APM reserves the rights to refuse product warranty service under the following circumstances:

1. The product is out of warranty period.
2. Inability to provide the purchasing invoice issued either by the product distributor or the installer besides of unable to determine the product manufacturer as APM.
3. APM logo or product label is missing or not readable.
4. Product is without an anti-dismantle label or the anti-dismantle label is damaged.
5. Accessories included with each product are not in the product warranty scope.
6. Defects or damages caused by or resulting from inadequate or improper repairs carried out by any person, entity or service facility which is not authorized by APM to perform warranty services on its behalf.
7. Defects or damages caused by or resulting from failure to comply with the operating instructions and contents specified in the related product manuals.
8. Defects or damages due to operation in very harsh environment that is beyond the limitations specified in this product manual.
9. Defects or damages due to the use of non-standard parts or software or parts which are not developed or manufactured by APM.
10. Defects or damages caused by or resulting from force majeure (including but not limited to lightning, immersion in liquid, etc.).
11. Defects or damages caused by or resulting from accidents or negligent use (including but not limited to transportation, storage, connection to incompatible voltage, improper operation, etc.).
12. Cosmetics defects or damages which won't affect normal operation of the product.

For the malfunction caused by above-mentioned circumstances, APM or its authorized service facility based on its own judgment is willing to provide a paid service in respond to our customer's request.

Schedule

Product Information		
Distributor	Company Name	
	Contact Person	
	Phone Code	
	Address	
User's Information		
User	Name	
	Phone Code	
	Address	
	Fax	
	E-mail	
Product Malfunction Information		
Model		
Serial No.		
Warranty Period		
Date of Malfunction	Signature	Malfunction Description & Solutions

Please stick the product
Serial number here.





APM TECHNOLOGY INT'L LTD

7/F., Kin On Commercial Building , 49-51 Jervois Street, Sheung Wan,
Hongkong.

Tel: (852)-21527388/21527399 Fax: (852)-35719160

MARKETED & SUPPORTED BY

SALICON NANO TECHNOLOGY PVT.LTD

111,First Floor, Laxmi Deep Tower,
Laxmi Nagar Distt. Center,
Delhi-110092,India

Tel.: +91-11-40618940

Web: www.salicontech.co.in,

Email: sales@salicontech.co.in