

M133C/133Ci

Electric Power/Energy Calibrator

Operation manual



Content

1	Basic information	4
2	Preparation for operation	5
2.1	Inspecting package contents, selecting the installation location.....	5
2.2	Power-on.....	6
2.3	Warm-up time.....	7
2.4	Replacement of fuse.....	7
2.5	Safety precautions.....	8
3	Description of controls	9
3.1	Front panel	9
3.2	Rear panel.....	14
4	Control of the calibrator	15
4.1	Selection of function	15
4.2	Setting the value of output signal	16
4.3	Connection / disconnection of output terminals	17
4.4	Generation of electric power.....	19
	Setting the power in modes Pdc Basic and Pac Basic	22
	Setting the power in modes Pdc High I and Pac High I (Three phase version only)	24
	Setting the power in modes Pdc Extended and Pac Extended	24
	Setting the power in P Harmonic mode (model M133C only).....	26
	Setting the power in P Interharmonic mode (model M133C only).....	28
	Setting the power in P Dip/Swell mode (model M133C only)	30
4.5	Generation of electric energy.....	32
	Setting the energy in modes Edc Basic and Eac Basic.....	36
	Setting the power in modes Edc High I and Eac High I (Three phase version only).....	37
4.6	Generation of calibrated voltage	37
	Setting the voltage in modes Udc Basic and Uac Basic	38
4.7	Generation of calibrated current	38
	Setting the current in modes Idc Basic and Iac Basic	40
	Setting the current in modes Idc High I and Iac High I (Three phase version only)	40
5	Multimeter	41
5.1	Function selection	41
6	Calibrator setup menu (Main menu)	42
6.1	General Menu.....	42
6.2	Interface Menu.....	43
6.3	Calibrator Menu	44

6.4	Meter Menu.....	47
6.5	Calibration Menu	47
7	<i>Calibration mode</i>	48
7.1	Calibration principles	48
7.2	Access to the calibration procedure.....	49
7.3	Selection of calibration type	50
7.4	Full calibration procedure.....	55
8	<i>Error messages</i>	59
9	<i>Maintenance</i>	61
10	<i>Verification test</i>	63
11	<i>System control</i>	69
11.1	IEEE488 bus properties.....	69
11.2	RS232 serial line setting.....	69
11.3	Command syntax.....	70
11.4	Standard Status Data Structures.....	136
12	<i>Specification</i>	140
13	<i>Versions & Options</i>	146
14	<i>Accessories</i>	146
	Certificate of conformity	147

1 Basic information

M133C Three (single) phase power calibrator is a multifunction calibrator, to be used primarily as a standard for calibration laboratories. It can be used for calibration of any measuring instrument which measures voltage, current, power, energy, phase and frequency. The calibrator is equipped with a built-in multimeter, which can be used simultaneously with output functions. Transducers of various types, regulators and sensing units can be therefore checked without the need for additional measuring instruments.

M133C model is equipped with special functions for power line voltage analyzers testing. It can generate calibrated harmonic and interharmonic distortion, fluctuation harmonics, flickers, ramp signals and others.

M133Ci model is delivered without the option of harmonic/interharmonic functions.

Basic features of the calibrator include generation of calibrated AC voltage in the range of 1 V to 600 V and DC voltage in the range of 1 V to 280 V, DC and AC current in the range of 5 mA to 30 A. Phase shift for all outputs (3x voltage and 3x current) can be set independent for each output. The best accuracy of the calibrator is 0.025 % for voltage and 0.035 % for current. Internal ranges (voltage 10, 30, 70, 140, 280 V and 600 Vac, current 0.3, 1, 2, 5, 10 and 30 A) are suitable for accurate testing of power transducers. Maximum frequency range is 15 Hz to 1000 Hz.

Internal multimeter with 20 mA, 10 V and 10 kHz (0.02 % accuracy) can be used to measure normalized signals coming from transducers.

The calibrator includes many other features which facilitate easy use. For example the possibility to save the actual setting into the internal memory, currently displayed uncertainty of the output signal, calibration and testing procedures etc. The concept of calibrator control and indication of its status is based on flat luminiscent display, which provides all necessary information. The calibrator is controlled by opening menus on the display and selection from menus. Frequently used functions are assigned direct-control keys. The calibrator comes with standard IEEE488 bus, RS-232 serial line and Ethernet connector, which allow the calibrator to be controlled from a PC.

The calibrator can easily fit within calibration systems featuring Power software support.

Calibrator is available in Three or Single phase version. Both versions look the same. The only difference is that the Single phase version doesn't contain channels 2 and 3. Single phase version can be upgraded to Three phase version by the manufacturer.

2 Preparation for operation

2.1 Inspecting package contents, selecting the installation location

Basic package includes the following items:

M133C

- Power/Energy calibrator
- Power cord
- Spare fuse
- Operational manual
- Test report
- Test cable 1000V/32A – 12 pcs (Three phase version), 4 pcs (Single phase version)
- RS232 cable
- M133C-01 High Current Adapter (Three phase version only)

The calibrator should be powered by 230/115 V – 50/60 Hz mains. It is a laboratory instrument whose parameters are guaranteed at 23 ± 2 °C. Before powering on the instruments, place it on a level surface. Do not cover the vents at the bottom side and the fan opening at the rear panel.

M133C-01 High Current Adapter (Three phase version only)



Standard part of delivery the three-phase power calibrator is the option M133C-01. Using this adapter all current outputs are connected in parallel and the configuration can deliver up to 90 A in single phase mode.

2.2 Power-on

- Before connecting the calibrator to the mains, check the position of the mains voltage selector located at the rear panel.
- Plug one end of the power cord into the connector located at the rear panel and connect the other end of the power cord into a wall outlet.
- Switch on the mains switch located at the rear panel. Flat display is lit.

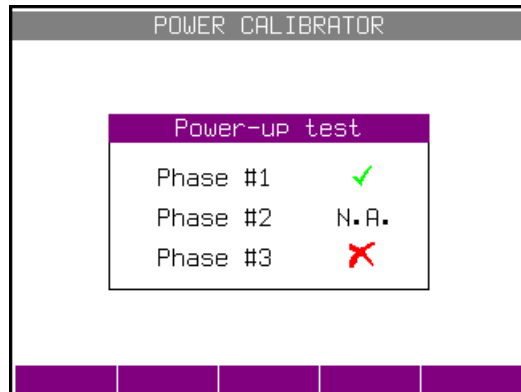

- The calibrator performs internal hardware checks for 5 seconds. Configuration of the instrument is displayed in the end of this test (connected phase channels).

- ✓ - phase unit is connected and ready
- N.A. - phase unit is not connected
- ✗ - phase is connected, but failed

- After the tests conclude, the calibrator resets to its reference state, i.e. the following parameters are set:

Function	AC power Pac Basic
Voltage range	10 V
Set value	10 V
Current range	1 A
Set value	1 A
Phase	0°
Frequency	50 Hz
Output terminals	OFF

GPIB address of the calibrator is factory-preset to 2. This value is valid until the user changes it.

2.3 Warm-up time

The calibrator works after it is switched on and the initial checks complete. Specified parameters are only guaranteed after the instrument warms up for 60 minutes. During this period, the instrument cannot be calibrated. The display shows “cannot access the calibration” message if calibration is attempted during this period.

2.4 Replacement of fuse

The calibrator includes a fuse located in the mains connector at the rear panel. Replace the fuse as follows:

- Switch off the calibrator
- Remove the end of power cord from the mains connector at the rear panel.
- Insert the blade of a flat screwdriver into the opening cut in the mains voltage selector and pull out the fuse holder.
- Remove the fuse and replace it with new fuse of the same rating.

2.5 Safety precautions

The instrument has been designed in Safety Class I according to EN 61010-1. The design reflects the requirements of A2 amendment of the standard.

Safety is ensured by the design and by the use of specific component types.

The manufacturer is not liable for the damage caused by modification of the construction or replacement of parts with non-original ones.

Safety symbols used on the equipment



Warning, reference to the documentation

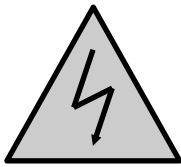

Warning - risk of electric shock



Danger - high voltage

3 Description of controls

3.1 Front panel

The front panel of the calibrator includes a TFT color display, control buttons and output terminals. The following picture shows the control part of the front panel.

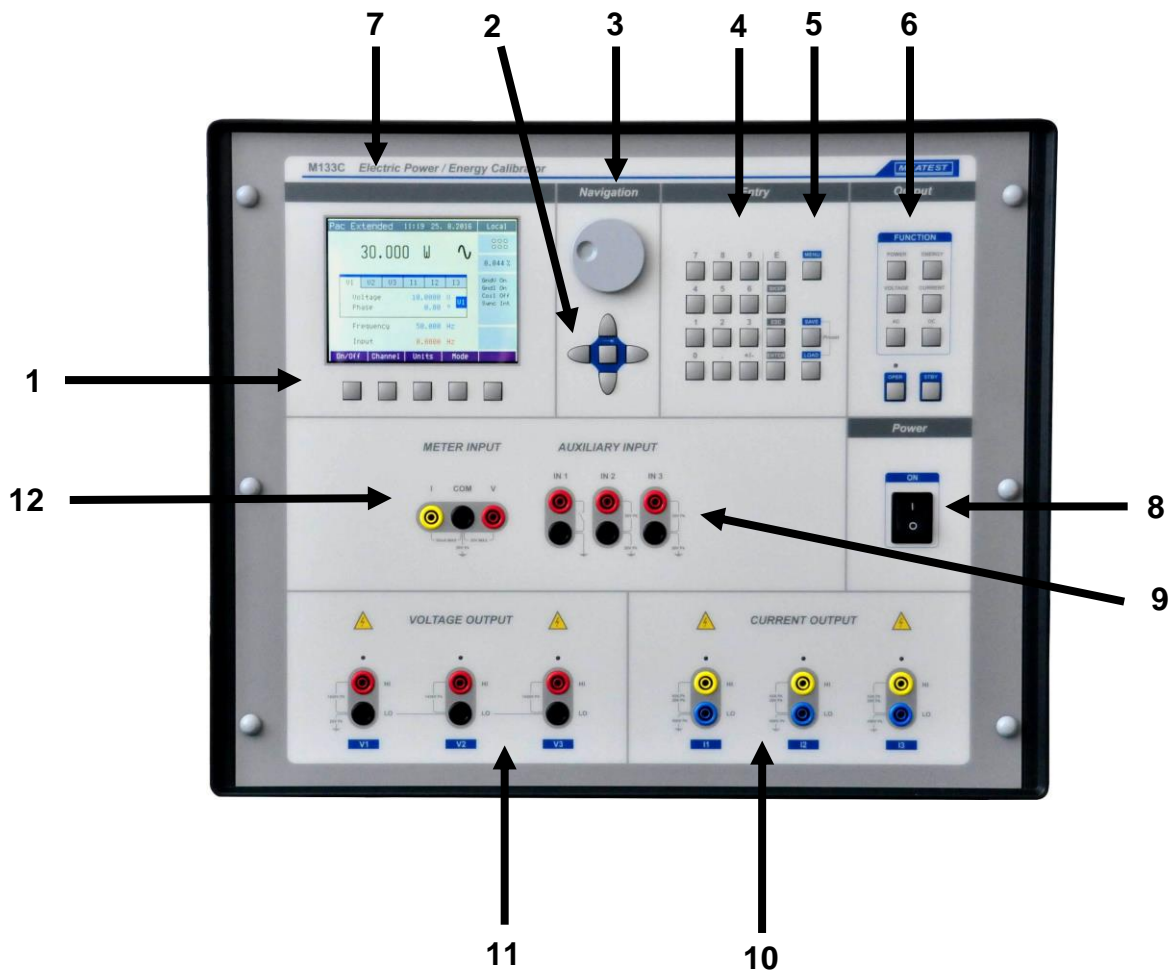

1 Display buttons

There are five buttons below the display, whose meaning changes depending on the contents of the display. These buttons usually call-up the “local Menu” (units, modes, etc.).

2 Cursor buttons

Using these buttons, the cursor can be controlled within allowed limits on the display. The keyboard includes two buttons (<, >) which allow the cursor to be set to the required position at the display. The cursor can be moved to the left or right. These buttons are usually used to step through the options and to move from one option to another or between the menu levels. Numeric values can be set in some control modes as well. In these cases, the buttons marked (^, v) allow the user to increase or decrease the number at the cursor button.

The central button is used to select value you want to change (TAB).

3 *Rotary knob*

The rotary knob integrates several functions. By turning the knob to the left or right, the user can:

- step through the options
- enter numeric values

The function of the rotary knob can usually be performed by the cursor buttons. The central button is used to confirm the selection (Select) or change the function of the rotary knob (value change or position change).

4 *Numeric keyboard*

The keyboard allows the entry of numeric values on the display. ENTER button is used to confirm the selection. CANCEL button can be used to cancel the entry.

5 *Direct keyboard*

MENU button is used to open the Main menu of the instrument (parameters setting). SAVE (RECALL) buttons can be used to save (recall) the actual setting of the instrument (all values including parameters). Capacity of the memory is up to 100 different settings. Each setting contains simple text description.

6 *Function buttons*

Function buttons can be used to call-up the functions of the calibrator directly. The following buttons are provided:

<i>function</i>	<i>key</i>
Power	P
Energy	E
Voltage	U
Current	I
AC	AC
DC	DC
Output ON (Operate)	ON
Output OFF (Standby)	OFF

After the function mode is changed, the parameters of the respective function are restored. If the respective function was never used, the calibrator resets to its reference values.

7 Display

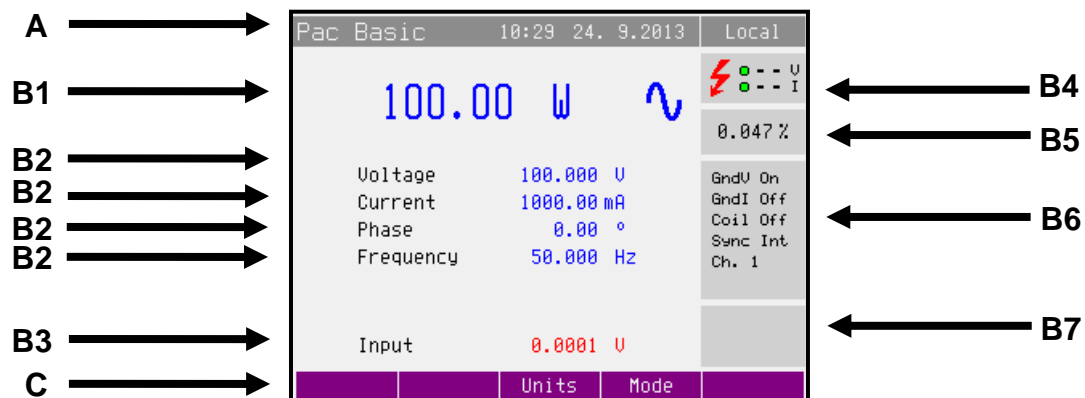

The display is divided to three horizontal sections:

A. Information line

- Selected function (Pac Basic – Power AC basic mode)
- Date and time
- Remote control state (Local – keyboard, Remote – computer)

B. Main area

This section displays the set-up values of generated signals and the data related to the calibrator status. The section includes the following types of data:

1. Main value

There is displayed main output value with the unit and indication of AC or DC (picture). There is displayed also actual position of cursor ▼▲ if the parameter is in edit mode. Position of cursor can be changed using keys <, > and parameter can be changed using keys ^, v, or using the rotary knob. If output voltage exceeds 50V sign of danger voltage is displayed before main value.

2. Auxiliary parameters

This section displays auxiliary parameters of actually selected function:

- Voltage (functions power and energy)
- Current (functions power and energy)
- Phase / Power factor (functions power and energy)
- Frequency (AC functions)
- Power (energy)
- Dose of energy (energy)

3. Measured value

Value measured using internal multimeter with unit. Value „over“ is displayed if measured signal is out of range.

4. Outputs state

Window displays which phase units are connected (one phase to three phase), which terminals are used for signal generation and also informs about output voltage higher than 50V.

Symbols displayed in window:

 - warning, displayed if output voltage is higher or equal 50V.

□ - phase unit (channel) is connected, output is off

■ - phase unit (channel) is connected, output is on

- - phase unit (channel) is not connected

5. *Specification*

In the field specification of set-up output signal is shown. Uncertainty is related to the main parameter. Label BUSY instead of accuracy is displayed, if calibrator is not within specified parameters or if internal reconnection is in process. This can occur during changing the functions, changing set parameters, switching output terminals ON and OFF. Specification is not available in power functions „P Harmonic“ and „P Interharmonic“.

6. *Information section*

The information section located in the right part of the display and displays additional information related to the selected function:

- information about the grounding method of output terminals: GndU, GndI as set up using the menu „Calibrator“.
- information about voltage terminal configuration (2-wire / 4-wire) as set up using the menu „Calibrator“.
- information about the use of 25-turn coil or 50-turn coil (COIL x50) as set up using the menu „Calibrator“.
- information about number of controlled output channels (only functions „Power Pac“ and „Energy Eac“).

7. *Meter's information section*

C. Display softkeys

The functions of these keys change during operation (depends on actual display mode).

8 Power switch

Turns instrument AC power ON and OFF.

9 Auxiliary input

Auxiliary input terminals for energy counting and for AC output signal synchronization.

10 Current output

Current outputs HI and LO terminals (three phases L1, L2 and L3).

11 Voltage output

Voltage outputs HI and LO terminals (three phases L1, L2 and L3).

12 Meter input

Input terminals for internal multimeter. The COM terminal is common for all measuring. The V terminal is for DC voltage (10V) and frequency (10kHz) measuring. The mA terminal is for DC current (20mA) measuring.

Colors on display

Common rules are used for applied color of labels and values.

- 1.*** Red color is applied, when displayed value is measured by the calibrator.
- 2.*** Blue color is applied for parameters or values, which can be set-up or modified directly from front panel keyboard or via Main menu.
- 3.*** Black color is used for fix values, labels, notes, parameters which cannot be modified and for other fix text with general information purpose.
- 4.*** Meaning of display buttons is always shown the lowest line. If there is no description above display button, the button is not active in selected function.

3.2 Rear panel

Rear panel includes ventilation holes, power cord socket, power line fuse, power line voltage selector 115/230V, fuse for internal multimeter, interface connectors GPIB, RS232 and RJ45, BNC outputs connectors and metal central ground terminal.

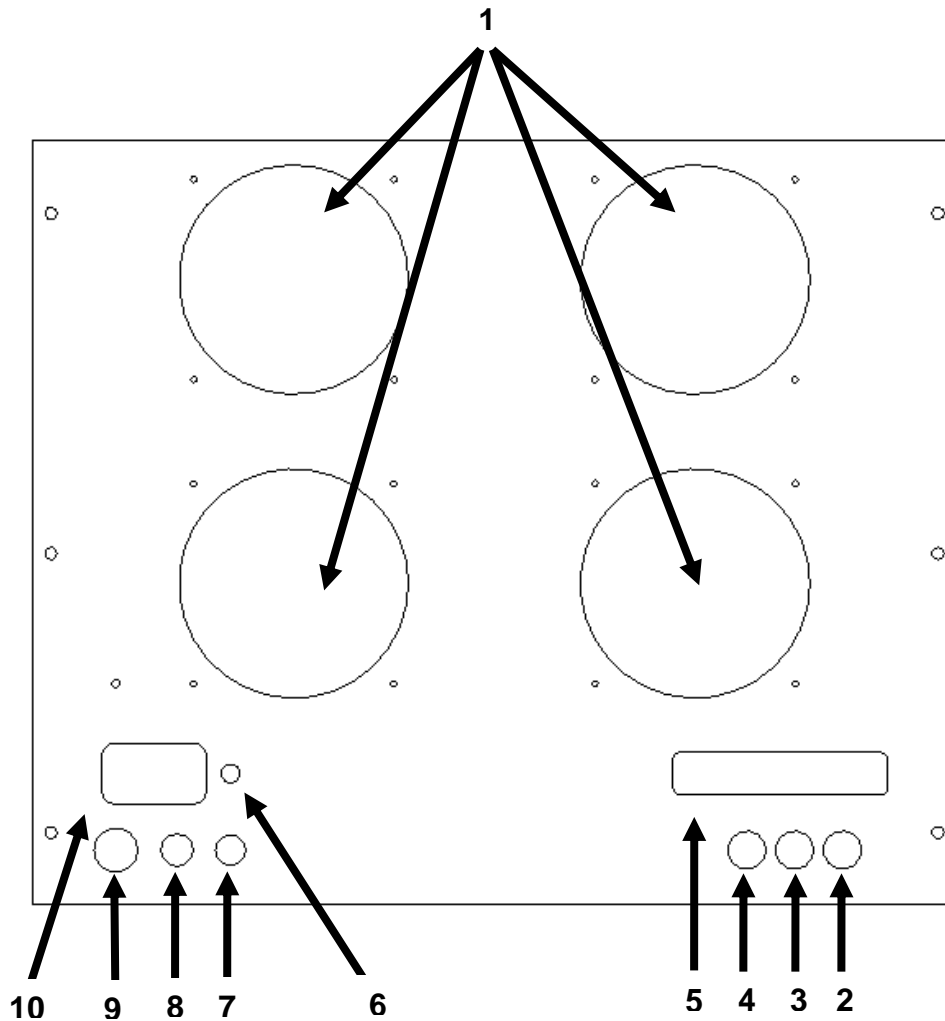

- 1 forced ventilation holes
- 2 energy pulse output - reference output (see Energy pulse output in Chapter 4.5)
- 3 sample reference output - manufacturing and service only
- 4 phase reference output - internal reference signal for 0 ° phase (all output channels are synchronized with this signal)
- 5 GPIB, RS-232 and RJ45 connectors
- 6 central ground terminal
- 7 power line switch
- 8 fuse for internal multimeter (T100mA / 250V)
- 9 power line fuse
- 10 power line entry

4 Control of the calibrator

4.1 Selection of function

After the power is switched on and the initial checks complete, the calibrator resets to its reference state:

Function:	Pac Basic
Voltage:	10V
Current:	1A
Phase:	0°
Frequency:	50Hz

The state of the calibrator can be changed using the buttons located at the front panel in one of the following ways:

1. *Change of function by pressing one of direct function buttons*

After pressing one of the buttons P, E, U, I, DC, AC calibrator switches to the selected function and set the last set-up parameters. Whenever function is changed, calibrator always goes over to STANBY position. Output terminals are disconnected. All functions with direct access has submenus, where various basic modes of the selected function can be chosen. Access to the submenu is always via display button Mode.

2. *Connection /disconnection of output terminals*

After pressing the ON button, the output terminals of the calibrator are connected. Only those terminals are activated which are aimed for DUT connection. To disconnect active terminals push the OFF button.

3. *Access to the Main menu*

After pressing the MENU button the calibrator displays the basic level of the setup menu. In this menu you can change instruments setting and calibration data. Previous function is recalled after pressing Exit softkey.

4.2 Setting the value of output signal

Edit mode

Parameters of output signal can be changed in Edit mode. Only parameters displayed in blue color can be changed. Display can be switched to edit mode in different ways:

- Pressing numeric button
- Pressing „Sel“ button (in the middle of cursors buttons)
- Pressing cursor button
- Pressing the rotary knob

In edit mode is edited value highlighted by blue background. Pressing the „Sel“ button you can change among „blue“ parameters. Edit mode is finished by pressing „Exit“ softkey.

Entry of the value using numeric keyboard

- Use the numeric keyboard to select the desired value. After the first digit is entered, input box is displayed. In the upper row of the input box is the name of edited parameter. Using softkeys you can enter the new value in different units.
- Enter desired value.
- After the entry is complete press softkey with requested unit or press „Enter“ button. „Enter“ button inputs the value in basic units (V, A, W, ...).

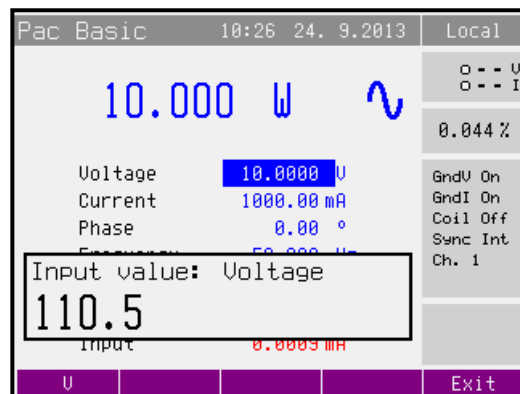

- Calibrator sets new value.
- The value is copied to the appropriate field in the screen and the input box disappears.

Entry of the value using cursor buttons

- Press <, >, ^ or v button. The display now includes cursor marks which points to the active digit.
- ^ and v buttons can be used to change the active digit. <, > buttons can be used to change the position of the cursor marks

- To get to the default screen, press „Exit“ button. All values can be set using the buttons or the rotary knob.

Entry of the value using the rotary knob

- Press the rotary knob. The display now includes cursor marks which points to the active digit.
- Turn the knob to change the active digit
- Press the rotary knob to change to the mode which allows to change the value of the active digit. ← and → symbols are displayed above the active digit. Active digit can be changed by turning the knob.
- Turn the knob to change the position of the active digit.
- To get to the default screen press „Exit“ button. All values can be set using the buttons or the rotary knob.

Note:

- All parameters have limits (high and low). If the entered value is outside these limits error message is displayed („Value too large (small)“) and new value is not accepted.

4.3 Connection / disconnection of output terminals

After switching the AC power supply on the output terminals are disconnected in all modes.

Press the “On” button to connect the output signal to the terminals. Green LED above the “On” button is lit.

Press the “Off” button to disconnect the output terminals. Green LED goes off.

Output terminals are disconnected automatically under following conditions:

- Function mode change
- Output voltage exceeds 100V. It occurs if you change the output value that is below 100V to the new value above 100V.
- Calibrator is overloaded.
- Changing some parameters of output signal (P Harmonic, etc.)
- Changing frequency for voltage above 280V
- Energy counting is finished.
- Output voltage exceeds 280V while current outputs are floating. It occurs if you change the output value that is below 280V to the new value above 280V and current

outputs are not grounded (GndI Off). Calibrator disconnects output terminals, grounds the current terminals and displays following message:

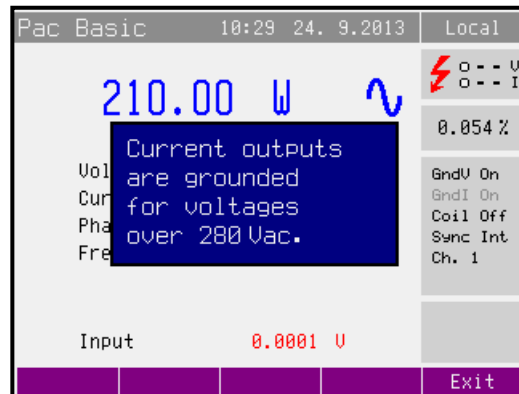

Grounding state of current outputs will be recovered according to the Setup Menu automatically as soon as the voltage will drop below 280V.

Control sequence when output voltage over 100 V is selected

When output voltage over 100 V is selected, the information section of the display shows the symbol which informs that a life-threatening voltage will be present at the output terminals. If the output terminals are currently connected, they will be disconnected when output voltage over 100 V is selected. ON button must be pressed to reconnect the output signal to the output terminals. After the ON button is pressed, ON LED is lit and the information section of the display shows the symbol notifying the user about the connection of the dangerous output signal to the output terminals.

Voltage, and frequency can be set without the outputs being disconnected. The output terminals are automatically disconnected when changing between AC and DC ranges or when changing the function mode.

4.4 Generation of electric power

The calibrator can generate exact value of electric power and energy. Power function modes provides output voltage at VOLTAGE OUTPUT HI – LO terminals and output current at CURRENT OUTPUT HI – LO terminals. Depending on the setting of the calibrator, voltage up to 600 Vef can be present at the terminals.

Power setting range:	0.005 VA to 18 kVA (each channel)
Voltage setting range:	1 to 600 Vac, 1 to 280 Vdc
Current setting range:	5 mA to 30 A
Power factor setting range:	-1 to +1 (phase 0 to +359.99 °)
Frequency setting range:	DC, 15 Hz to 1 kHz

Control in the power mode

- Press “P” button on the calibrator and then select AC or DC mode by pressing „AC“ or „DC” button. The display shows the following data:
 - * main value of set power in selected unit of measurement VA, W, VAR
 - * voltage at VOLTAGE OUTPUT HI-LO terminals
 - * current through CURRENT OUTPUT HI-LO terminals
 - * power factor or the phase shift between the voltage and current in °.
 - * frequency, if AC power is selected
 - * uncertainty of set power
- Set desired value of power using numeric keyboard, potentiometer or cursor buttons. Output power is not yet connected to the output terminals.
- Connect the instrument to be calibrated to VOLTAGE OUTPUT HI-LO and CURRENT OUTPUT HI-LO terminals or short the CURRENT OUTPUT HI-LO terminals.
- Press OUTPUT button.
- Green LED is lit above the “On” button to indicate the connection of simulated electrical power to the output terminals. Connected terminals are also displayed in the „Outputs state” window as green circles.

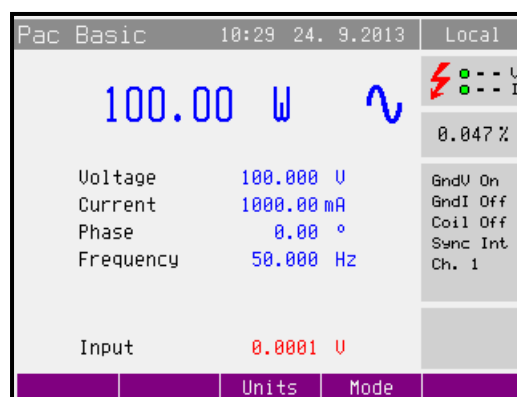

Desired power is connected to output terminals.

Power factor polarity (Lead/Lag softkey)

In case that phase shift between voltage and current is expressed as power factor you can change its polarity using „Lead/Lag“ softkey. The Lead polarity presents capacity load (current before voltage). The Lag polarity presents inductance load (voltage before current).

Power units (Units softkey)

The calibrator can display AC power in one of three ways:

- apparent power in VA
- active power in W
- reactive power in VAR

Use “Units” softkey to open the units selection menu. Select the required expression using cursor buttons or the rotary knob. Confirm the selection by pressing the rotary knob or the “Select” softkey. The value of displayed power is recalculated together with new units selection. DC power can be expressed only in W.

The calibrator can display the phase relation of output voltage and current as power factor (–1 to +1) or as phase shift in degrees (0 to 359.99 °). Main menu is used to change the method of displaying the phase relation.

Power modes (Mode softkey)

Output power can be generated in different power modes:

AC power

Mode	Name	Description
Basic	Pac Basic	AC power basic mode. Phase shift between channels output voltages are fixed (120° and 240°). All parameters are the same for all channels. Number of active channels can be defined in Main menu (1, 2 or 3).
High I	Pac High I	In this mode current outputs of all channels are connected in parallel (using the M133C-01 High Current Adapter). Current range is increased three times.
Extended	Pac Extended	Parameters for all calibrators outputs (3x voltage, 3x current) can be set quite independently in this mode. For each output you can define amplitude (V or A) and phase shift (°). Phase shift is relative to the internal reference.
Harmonic (version M133C only)	P Harmonic	Mode is used for generation harmonic signal composed of up to 50 harmonic components. All components can be defined independently for all outputs (3x voltage, 3x current). Beside this mode allows modulation by sine or square signal.
Interharmonic (version M133C only)	P Iharmonic	Mode is used for generation interharmonic signal. One interharmonic component can be add independently for all outputs (3x voltage, 3x current).
Dip/Swell (version M133C only)	P Dip/Swell	Mode is used for generation dips or swells on the output signal. All parameters can be defined independently for all outputs (3x voltage, 3x current).

DC power

Mode	Name	Description
Basic	Pdc Basic	DC power basic mode. Only first channel 1 is controlled in this mode.
High I	Pdc High I	In this mode current outputs of all channels are connected in parallel (using the M133C-01 High Current Adapter). Current range is increased three times.
Extended	Pdc Extended	Parameters for all calibrators outputs (3x voltage, 3x current) can be set quite independently in this mode. For each output you can define amplitude (V or A).

Use „Mode“ softkey to open the mode selection menu. Select the required mode using cursor buttons or the rotary knob. Confirm the selection by pressing the rotary knob or the “Select” softkey. Output terminals are disconnected if the new mode is selected.

Setting the power in modes Pdc Basic and Pac Basic

The calibrator allows several ways of setting the value of generated power.

1. Setting the main power value

- The main value can be changed using numeric keyboard, changing the digit at the cursor position after selecting the cursor position with <, > buttons or using the rotary knob.

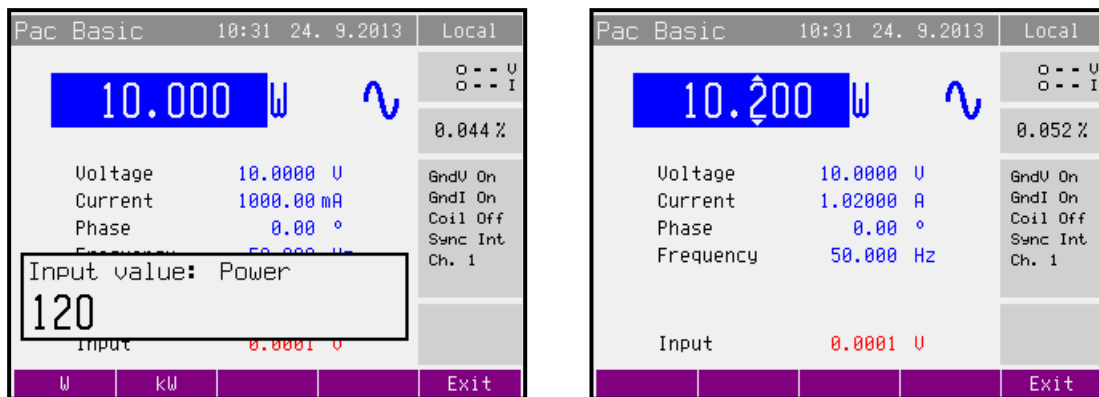

- Output power is changed by changing the value of output current.

2. Setting the voltage

- The main power value can be changed by changing the voltage.
- Repeatedly press the “Sel” button (in the middle of cursor buttons) until the voltage value appears in edit mode (blue background).
- The value can be set using numeric keyboard and confirmed by pressing V softkey. The value can be set using cursor buttons or rotary knob as well.

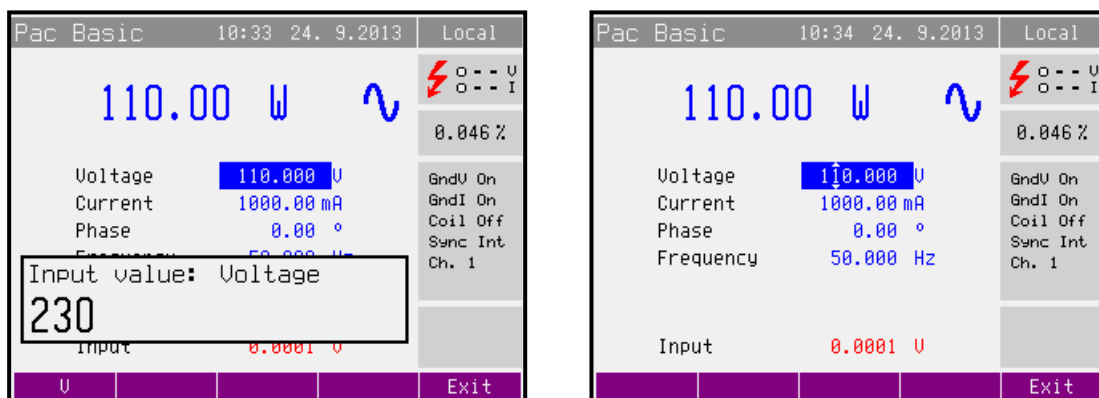

- Main power value is recalculated using new set voltage and existing setting of current and power factor.

Note: Read also chapter 4.3 Connection / disconnection of output terminals.

3. Setting the current

- The main power value can be changed by changing the current.
- Repeatedly press the “Sel” button (in the middle of cursor buttons) until the current value appears in edit mode (blue background).
- The value can be set using numeric keyboard and confirmed by pressing mA or A softkey. The value can be set using cursor buttons or rotary knob as well.

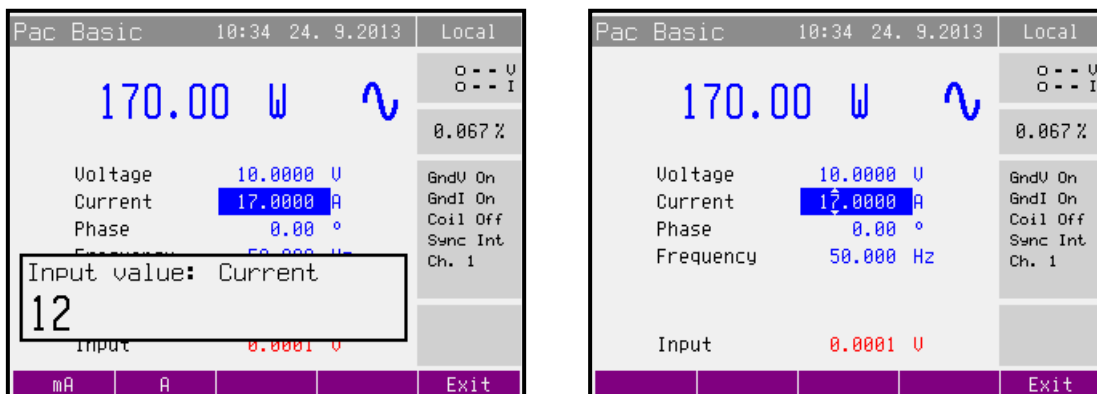

- Main power value is recalculated using new set current and existing setting of voltage and power factor.

4. Setting the power factor (AC power only)

- If W or Var is indicated, the main power value can be changed by changing the power factor. Change of power factor does not change the output apparent power.
- Repeatedly press the “Sel” button (in the middle of cursor buttons) until the power factor (phase) value appears in edit mode (blue background).
- The value can be set using numeric keyboard and confirmed by pressing Lead or Lag softkey. The value can be set using cursor buttons or rotary knob as well.

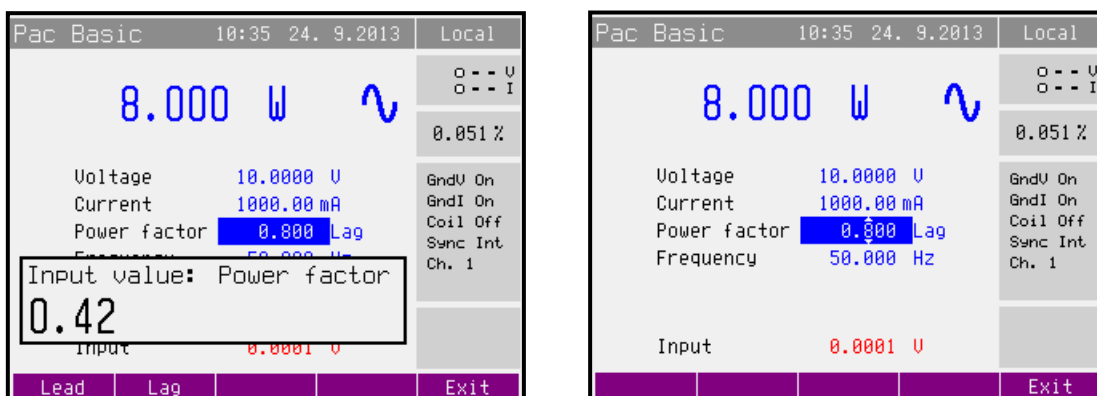

- Main power value is recalculated using new set power factor and existing setting of current and voltage. The calculation is only made if active or reactive power is displayed.

Setting the power in modes Pdc High I and Pac High I (Three phase version only)

In this mode current outputs of all channels are connected in parallel using optional adapter. Current range is increased three times.

Voltage terminal Channel 1 are used in high current modes.

Power setting is the same as in modes Pdc Basic a Pac Basic.

Setting the power in modes Pdc Extended and Pac Extended

Modes allow independent parameter setting for all calibrators outputs (3x voltage, 3x current) For each output you can define amplitude (V or A) and phase shift (°). Phase shift is relative to the internal reference.

The main power value displays summed power calculated as sum of power of all connected channels. It is not possible to change this value directly. Color of this value is black.

Each calibrators output (U1, U2, U3, I1, I2, I3) is displayed as a folder. The folder U1 is active after selecting the Extended mode. Next folders are activated by repeatedly pressing „Channel“ softkey.

Pressing „On/Off“ softkey disables (enables) the active output. Only enabled outputs will be connected after pressing the „On“ button. Enabled outputs are highlighted by blue rectangle above the output name. After the AC power on all outputs of connected phase units (channels) are enabled.

Picture displays state after AC power on. Both outputs of main phase unit are enabled, active is output U1.

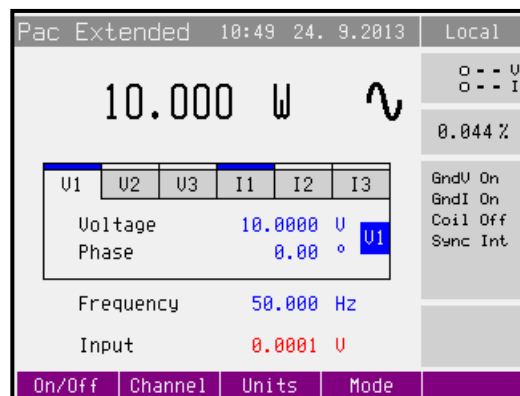

1. Setting the amplitude of voltage (current)

- The main power value can be changed by changing the amplitude of voltage (current).
- Repeatedly press the “Sel” button (in the middle of cursor buttons) until the voltage (current) value appears in edit mode (blue background).

- The value can be set using numeric keyboard and confirmed by pressing V (mA, A) softkey. The value can be set using cursor buttons or rotary knob as well.

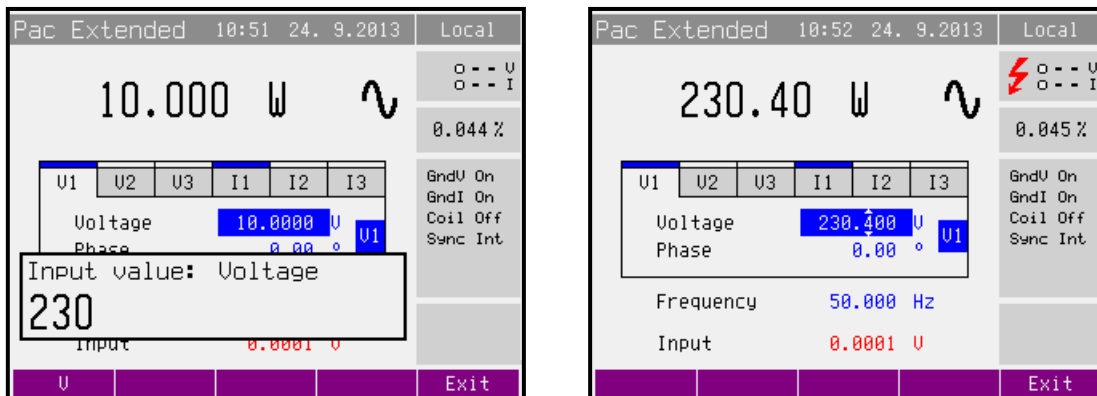

- Main power value is recalculated using new amplitude.
- Next folders (outputs) are activated by repeatedly pressing „Channel“ softkey.

Note: Read also chapter 4.3 Connection / disconnection of output terminals.

2. Setting the phase (AC power only)

- If W or Var is indicated, the main power value can be changed by changing the power factor. Change of power factor does not change the output apparent power.
- Repeatedly press the “Sel” button (in the middle of cursor buttons) until the phase value appears in edit mode (blue background).
- The value can be set using numeric keyboard and confirmed by pressing ° softkey. The

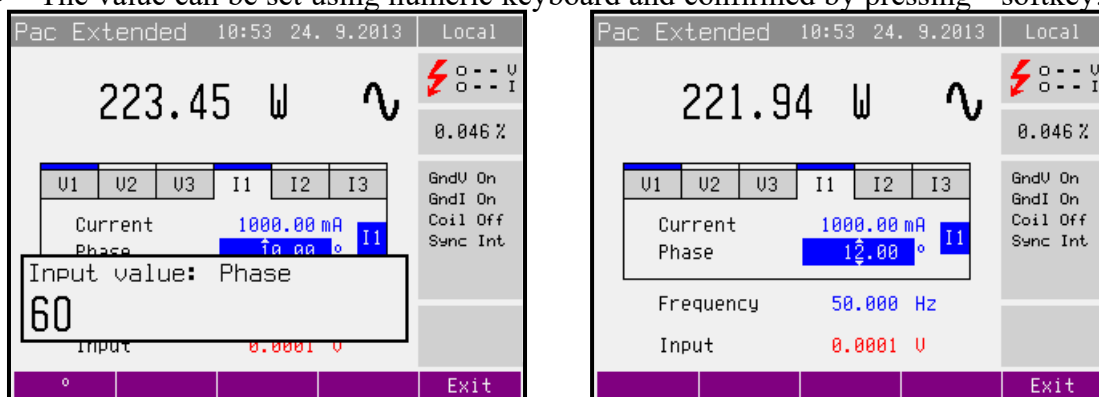

value can be set using cursor buttons or rotary knob as well.

- Main power value is recalculated using new set phase and existing setting of current and voltage. The calculation is only made if active or reactive power is displayed.
- Next folders (outputs) are activated by repeatedly pressing „Channel“ softkey.

3. Setting the frequency (AC power only)

- Repeatedly press the “Sel” button (in the middle of cursor buttons) until the frequency value appears in edit mode (blue background).

- The value can be set using numeric keyboard and confirmed by pressing Hz softkey. The value can be set using cursor buttons or rotary knob as well.

Setting the power in P Harmonic mode (model M133C only)

Mode is used for generation harmonic signal composed of up to 50 harmonic components. All components can be defined independently for all outputs (3x voltage, 3x current). Beside this mode allows modulation by sine or square signal.

Each calibrators output (U1, U2, U3, I1, I2, I3) is displayed as a folder. The folder U1 is active after selecting the Harmonic mode. Next folders are activated by repeatedly pressing „Channel“ softkey.

Pressing „On/Off“ softkey disables (enables) the active output. Only enabled outputs will be connected after pressing the „On“ button. Enabled outputs are highlighted by blue rectangle above the output name. After the AC power on all outputs of connected phase units (channels) are enabled.

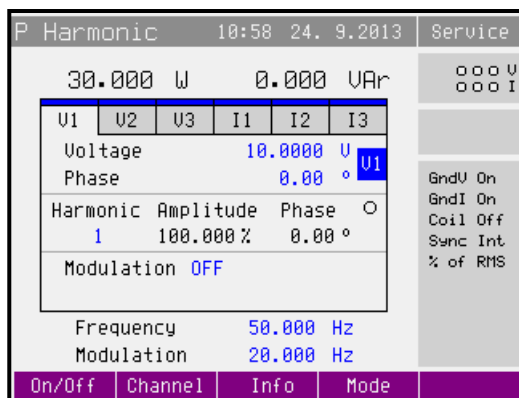

Harmonics defined as “% of RMS”

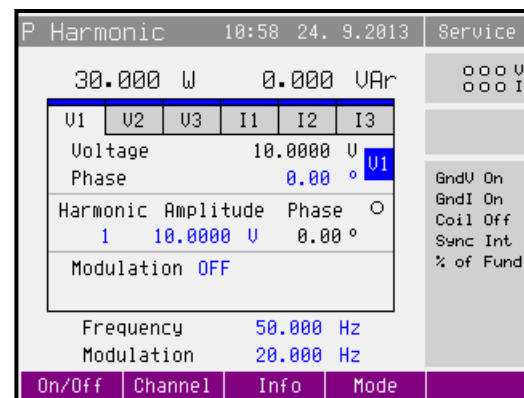

Harmonics defined as “% of Fundamental”

Pressing „Info“ button displays informative window. There is displayed used range for every output. Range is important for uncertainty calculation, because the uncertainty is not displayed in mode P Harmonic.

Internal multimeter is not available in P Harmonic mode.

1. Setting the amplitude of voltage (current)

Amplitude can be defined as RMS value (harmonics components are defined as % of RMS) or Fundamental harmonic value (harmonics components are defined as % of Fundamental harmonic).

- Repeatedly press the “Sel” button (in the middle of cursor buttons) until the voltage (current) value appears in edit mode (blue background).
- The value can be set using numeric keyboard and confirmed by pressing V (mA, A) softkey. The value can be set using cursor buttons or rotary knob as well.
- Output terminals are disconnected if new amplitude is set.
- Next folders (outputs) are activated by repeatedly pressing „Channel“ softkey.

Note: Read also chapter 4.3 Connection / disconnection of output terminals.

2. Setting the phase

- Repeatedly press the “Sel” button (in the middle of cursor buttons) until the phase value appears in edit mode (blue background).
- The value can be set using numeric keyboard and confirmed by pressing ° softkey. The value can be set using cursor buttons or rotary knob as well.
- Next folders (outputs) are activated by repeatedly pressing „Channel“ softkey.

3. Setting amplitude and phase of harmonic components

- First should be selected required harmonic component (1-50). Repeatedly press the “Sel” button (in the middle of cursor buttons) until the parameter Harmonic appears in edit mode (blue background).
- Number of harmonic component can be set using numeric keyboard and confirmed by pressing „Enter“ button. The value can be set using cursor buttons or rotary knob as well. Next to the harmonic component number is displayed amplitude and phase of this harmonic component.
- Pressing the „Sel“ button appears the amplitude of selected harmonic component in edit mode (blue background). This is not valid for the fundamental harmonic (1. harmonic component) if harmonics components are defined as % of RMS. Amplitude of fundamental harmonic is calculated using the RMS value of output signal and amplitudes of harmonic components 2-50 in this case.
- Amplitude of harmonic components 2-50 can be set using numeric keyboard and confirmed by pressing „%“ softkey. The value can be set using cursor buttons or rotary knob as well. Amplitude can be set in range 0 to 30.000%. Amplitude is expressed as % of RMS value or % of Fundamental harmonic.
- Phase of harmonic components 2-50 can be set using numeric keyboard and confirmed by pressing „°“ softkey. The value can be set using cursor buttons or rotary knob as well. Phase can be set in range 0.00 to 359.99 °.
- „Harm+“ („Harm-“) softkeys facilitate listing among harmonics components. Softkeys displays amplitude of next (previous) harmonic component.
- „Ampl. “ („Phase “) softkeys switch between Amplitude and Phase edit mode for selected harmonic component.
- All harmonic components 2-50 can be cleared by pressing „Clear“ softkey. „Clear“ softkey is available if the fundamental harmonic is displayed.
- Output terminals are disconnected if new amplitude is set.

4. Setting of modulation

- After AC power on modulation is switched off (OFF). First should be selected shape of modulation signal. Repeatedly press the “Sel” button (in the middle of cursor buttons) until the parameter Modulation appears in edit mode (blue background). Shape can be selected using „SIN“, „RECT“ or „OFF“ softkey. Duty cycle (1 to 99%) is available for rectangular modulation signal.

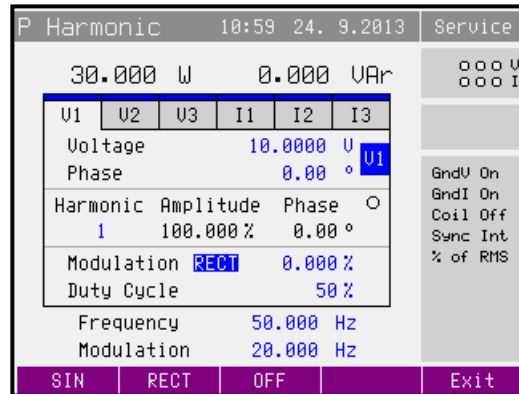

- All harmonic components are modulated by modulation signal.
- Frequency of modulation signal is determined by parameter „Modulation“.

Setting the power in P Interharmonic mode (model M133C only)

Mode is used for generation signal composed of fundamental harmonic and one interharmonic component. All parameters can be defined independently for all outputs (3x voltage, 3x current).

Each calibrators output (U1, U2, U3, I1, I2, I3) is displayed as a folder. The folder U1 is active after selecting the Interharmonic mode. Next folders are activated by repeatedly pressing „Channel“ softkey.

Pressing „On/Off“ softkey disables (enables) the active output. Only enabled outputs will be connected after pressing the „On“ button. Enabled outputs are highlighted by blue rectangle above the output name. After the AC power on all outputs of connected phase units (channels) are enabled.

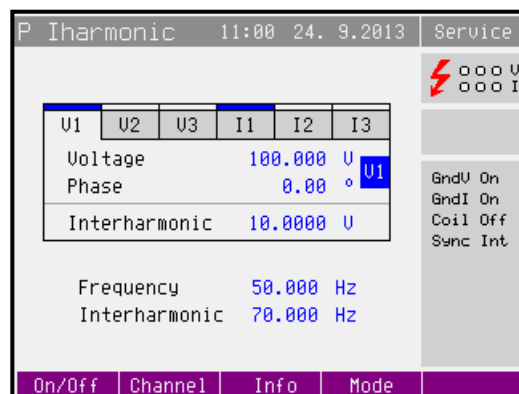

Pressing „Info“ button displays informative window. There is displayed used range for every output. Value of used range is important for uncertainty calculation, because the uncertainty is not displayed in P Interharmonic mode.

Internal multimeter is not available in P Interharmonic mode.

1. Setting the amplitude (RMS value) of voltage (current)

- Repeatedly press the “Sel” button (in the middle of cursor buttons) until the voltage (current) value appears in edit mode (blue background).
- The value can be set using numeric keyboard and confirmed by pressing V (mA, A) softkey. The value can be set using cursor buttons or rotary knob as well.
- Output terminals are disconnected if new amplitude is set.
- Next folders (outputs) are activated by repeatedly pressing „Channel“ softkey.

2. Setting the phase

- Repeatedly press the “Sel” button (in the middle of cursor buttons) until the phase value appears in edit mode (blue background).
- The value can be set using numeric keyboard and confirmed by pressing ° softkey. The value can be set using cursor buttons or rotary knob as well.
- Next folders (outputs) are activated by repeatedly pressing „Channel“ softkey.

3. Setting the amplitude (RMS value) of interharmonic component

- Repeatedly press the “Sel” button (in the middle of cursor buttons) until the interharmonic value appears in edit mode (blue background).
- The value can be set using numeric keyboard and confirmed by pressing V (mA, A) softkey. The value can be set using cursor buttons or rotary knob as well.
- Output terminals are disconnected if new amplitude is set.
- Next folders (outputs) are activated by repeatedly pressing „Channel“ softkey.

Setting the power in P Dip/Swell mode (model M133C only)

Mode is used for generation dips or swells on the output signal. All parameters can be defined independently for all outputs (3x voltage, 3x current).

Each calibrators output (U1, U2, U3, I1, I2, I3) is displayed as a folder. The folder U1 is active after selecting the Dip/Swell mode. Next folders are activated by repeatedly pressing „Channel“ softkey.

Pressing „On/Off“ softkey disables (enables) the active output. Only enabled outputs will be connected after pressing the „On“ button. Enabled outputs are highlighted by blue rectangle above the output name. After the AC power on all outputs of connected phase units (channels) are enabled.

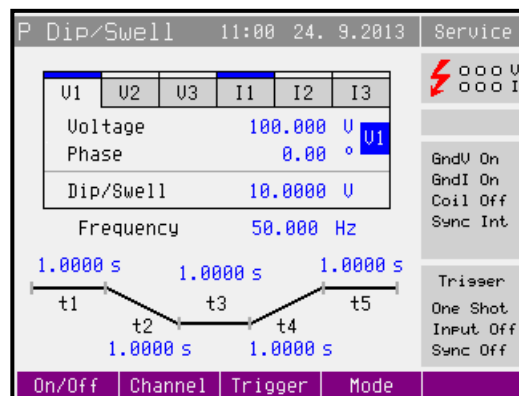

Pressing „Trigger“ button starts generation of Dip/Swell shape. Generation can be started (triggered) also from input IN3. Dip/Swell shape is divided into five time periods. Length of these periods can be changed. Active period is during the generation shown in the box.

- t1 Voltage (Current) amplitude is generated during period t1 after trigger
- t2 amplitude is fluently changed to Dip/Swell amplitude
- t3 Dip/Swell amplitude is generated
- t4 amplitude is fluently changed to Voltage (Current) amplitude
- t5 Voltage (Current) amplitude is generated

There are following trigger parameters in Setup menu:

Dip/Swell repetition:

- One Shot - trigger starts generation of one Dip/Swell shape
- Repeat - trigger starts repeated generation of Dip/Swell shapes

Dip/Swell synchronization:

- Sync Off - Dip/Swell shape starts immediately after trigger
- Sync On - start of Dip/Swell shape is synchronized with the phase 0°

Dip/Swell ext. trigger

- Input Off - Dip/Swell can be triggered only internal (keyboard or remote control)
- Input IN3 - Dip/Swell can be triggered internal or by external TTL falling edge signal applied to input IN3

Internal multimeter is not available in P Dip/Swell mode.

1. Setting the amplitude (RMS value) of voltage (current)

- Repeatedly press the “Sel” button (in the middle of cursor buttons) until the voltage (current) value appears in edit mode (blue background).
- The value can be set using numeric keyboard and confirmed by pressing V (mA, A) softkey. The value can be set using cursor buttons or rotary knob as well.
- Output terminals are disconnected if new amplitude is set.
- Next folders (outputs) are activated by repeatedly pressing „Channel“ softkey.

2. Setting the phase

- Repeatedly press the “Sel” button (in the middle of cursor buttons) until the phase value appears in edit mode (blue background).
- The value can be set using numeric keyboard and confirmed by pressing ° softkey. The value can be set using cursor buttons or rotary knob as well.
- Next folders (outputs) are activated by repeatedly pressing „Channel“ softkey.

3. Setting the amplitude (RMS value) of Dip/Swell

- Repeatedly press the “Sel” button (in the middle of cursor buttons) until the Dip/Swell value appears in edit mode (blue background).
- The value can be set using numeric keyboard and confirmed by pressing V (mA, A) softkey. The value can be set using cursor buttons or rotary knob as well.
- Output terminals are disconnected if new amplitude is set.
- Next folders (outputs) are activated by repeatedly pressing „Channel“ softkey.

4. Setting Dip/Swell time periods

- Repeatedly press the “Sel” button (in the middle of cursor buttons) until required time period (t1, t2, t3, t4 or t5) appears in edit mode (blue background).
- The value can be set using numeric keyboard and confirmed by pressing ms (s) softkey. The value can be set using cursor buttons or rotary knob as well.
- Output terminals are disconnected if new time is set.
- Next folders (outputs) are activated by repeatedly pressing „Channel“ softkey.

4.5 Generation of electric energy

The calibrator can generate exact value of electric power and energy. Energy function modes provides output voltage at VOLTAGE OUTPUT HI – LO terminals and output current at CURRENT OUTPUT HI – LO terminals. Depending on the setting of the calibrator, voltage up to 600 Vef can be present at the terminals.

Power setting range:	0.005 VA to 18 kVA (each channel)
Voltage setting range:	1 to 600 Vac, 1 to 280 Vdc
Current setting range:	5 mA to 30 A
Power factor setting range:	-1 to +1 (phase 0 to +359.99 °)
Time setting range:	1 to 10000 s
Frequency setting range:	DC, 15 Hz to 1 kHz

Energy pulse output (only for calibrators with this output)

Energy pulse output is located on the rear panel (BNC connector in the right bottom corner). Frequency of pulses is proportional to the energy generated by calibrator and is defined by the energy meter constant (can be changed in setup menu).

There are two types of output selectable in setup menu:

- open collector (up to 30V / 100mA)
- open collector with the pull-up resistor 150Ω connected to +5V

Frequency range of energy pulse output: 0.02 Hz to 1 MHz

Control in the energy mode

- Press “E” button on the calibrator and then select AC or DC mode by pressing „AC“ or „DC“ button. The display shows the following data:

Eac Basic		11:01 24. 9.2013	Service
0.000 mWs		~	000 U 000 I
Deviation	- %		0.044 %
Voltage	10.0000 U		GndV On
Current	1000.00 mA		GndI On
Power factor	1.000 Lag		Coil Off
Frequency	50.000 Hz		Sync Int
Meter const.	1.000000 i/kWh		Ch. 1
Control mode			
Test	100 i		Counter
Warm-up	100 i		IN1
Control	Lead/Lag	Units	Mode

- * main value – running energy counter in selected unit of measurement VAs, Ws, VARs
- * deviation between energy meter and calibrator – calculation is based on pulses generated by meter
- * voltage at VOLTAGE OUTPUT HI-LO terminals
- * current through CURRENT OUTPUT HI-LO terminals
- * power factor or the phase shift between the voltage and current in °.
- * frequency, if AC power is selected
- * meter constant (number of pulses per kWh/kVAh/kVARh generated by energy meter)

- * energy counting method (control mode)
 - * uncertainty of energy and deviation
-
- Set desired energy parameters using numeric keyboard, rotary knob or cursor buttons. Output power is not yet connected to the output terminals.
 - Connect the instrument to be calibrated to VOLTAGE OUTPUT HI-LO and CURRENT OUTPUT HI-LO terminals or short the CURRENT OUTPUT HI-LO terminals.
 - Select the Control mode.
 - Press ON button.
 - Green LED is lit above the “On” button to indicate the connection of simulated electrical power to the output terminals. The calibrator starts energy dose generation. Main value displays running energy, control mode parameters displays running time, counted pulses or measured frequency. Current terminals are disconnected as soon as energy batch is finished. Voltage terminals are disconnected only if parameter “Maintain Voltage Signal” is set to “Off”. Otherwise the voltage terminals are disconnected after pressing “OFF” button.

Ways of energy counting (Control)

Calibration of Energy meter:



There are different ways how to control the energy dose counting.

Packet (Time counting)

The simplest (but less accurate) way is to count the time.

Counter / Timer (Pulse counting)

The other way is to count pulses from energy meter. This method is called „rolling start“ method. Meter must be connected to input IN1 or IN2. Press the ON key on the calibrator. The calibrator starts to count energy after counting “Warm-up” pulses from the meter (rolling start). Counting is finished after the set number of “Test” pulses is reached. The calibrator disconnects the output terminals and shows energy delivered between set number of “Test” pulses. Calibrator also displays deviation of the meter in % (meter constant must be defined).

In Counter mode is measuring interval defined by number of pulses. In Timer mode is measuring interval defined by time.

Free run (Frequency measuring)

Calibrator measures frequency of pulses from measured meter. Meter must be connected to input IN1, IN2 or Meter. Deviation between meter and calibrator is continuously calculated and displayed (meter constant must be defined). Calibrator displays deviation between measured and internal "reference frequency" in %.

Use “Control” softkey to open the energy counting method selection menu. Select the required method using cursor buttons or the rotary knob. Confirm the selection by pressing the rotary knob or the “Select” softkey.

Power factor polarity (*Lead/Lag softkey*)

In case that phase shift between voltage and current is expressed as power factor you can change its polarity using „Lead/Lag“ softkey. The Lead polarity presents capacity load (current before voltage). The Lag polarity presents inductance load (voltage before current).

Power units (*Units softkey*)

The calibrator can display AC power (energy) in one of three ways:

- apparent power in VA (VAs)
- active power in W (Ws)
- reactive power in Var (VARs)

Use “Units” softkey to open the units selection menu. Select the required expression using cursor buttons or the rotary knob. Confirm the selection by pressing the rotary knob or the “Select” softkey. The value of displayed power is recalculated together with new units selection. DC power (energy) can be expressed only in W (Ws).

The calibrator can display the phase relation of output voltage and current as power factor (–1 to +1) or as phase shift in degrees (0 to 359.99 °). Main menu is used to change the method of displaying the phase relation.

Energy modes (Mode softkey)

Output energy can be generated in different energy modes:

AC energy

Mode	Name	Description
Basic	Eac Basic	AC energy basic mode. Phase shift between channels output voltages are fixed (120° and 240°). All parameters are the same for all channels. Number of active channels can be defined in Main menu (1, 2 or 3).
High I	Eac High I	In this mode current outputs of all channels are connected in parallel (using the M133C-01 High Current Adapter). Current range is increased three times.

DC energy

Mode	Name	Description
Basic	Edc Basic	DC energy basic mode. Only first channel 1 is controlled in this mode.
High I	Edc High I	In this mode current outputs of all channels are connected in parallel (using the M133C-01 High Current Adapter). Current range is increased three times.

Use „Mode“ softkey to open the mode selection menu. Select the required mode using cursor buttons or the rotary knob. Confirm the selection by pressing the rotary knob or the “Select” softkey. Output terminals are disconnected if the new mode is selected.

Setting the energy in modes Edc Basic and Eac Basic

The calibrator allows several ways of setting the value of generated energy.

1. Setting the voltage

- The energy (power) value can be changed by changing the voltage.
- Repeatedly press the “Sel” button (in the middle of cursor buttons) until the voltage value appears in edit mode (blue background).
- The value can be set using numeric keyboard and confirmed by pressing V softkey. The value can be set using cursor buttons or rotary knob as well.
- Energy (power) value is recalculated using new set voltage and existing setting of current and power factor.

Note: Read also chapter 4.3 Connection / disconnection of output terminals.

2. Setting the current

- The energy (power) value can be changed by changing the current.
- Repeatedly press the “Sel” button (in the middle of cursor buttons) until the current value appears in edit mode (blue background).
- The value can be set using numeric keyboard and confirmed by pressing mA or A softkey. The value can be set using cursor buttons or rotary knob as well.
- Energy (power) value is recalculated using new set current and existing setting of voltage and power factor.

3. Setting the power factor (AC power only)

- If Ws or VAr is indicated, the energy (power) value can be changed by changing the power factor. Change of power factor does not change the output apparent energy.
- Repeatedly press the “Sel” button (in the middle of cursor buttons) until the power factor (phase) value appears in edit mode (blue background).
- The value can be set using numeric keyboard and confirmed by pressing Lead or Lag softkey. The value can be set using cursor buttons or rotary knob as well.
- Energy (power) value is recalculated using new set power factor and existing setting of current and voltage. The calculation is only made if active or reactive power is displayed.

4. Setting the frequency (AC energy only)

- Repeatedly press the “Sel” button (in the middle of cursor buttons) until the frequency value appears in edit mode (blue background).
- The value can be set using numeric keyboard and confirmed by pressing Hz softkey. The value can be set using cursor buttons or rotary knob as well.

5. Setting the Meter constant

Meter constant defines number of pulses sent by the meter for selected energy unit.

- Repeatedly press the “Sel” button (in the middle of cursor buttons) until the Meter constant value appears in edit mode (blue background).
- The value can be set using numeric keyboard and confirmed by pressing Enter softkey. The value can be set using cursor buttons or rotary knob as well.

6. Setting the time (test, warm-up counters)

- Repeatedly press the “Sel” button (in the middle of cursor buttons) until the time value (or “Test” / “Warm-up” values) appears in edit mode (blue background).
- The value can be set using numeric keyboard and confirmed by pressing Enter softkey. The value can be set using cursor buttons or rotary knob as well.

Setting the power in modes Edc High I and Eac High I (Three phase version only)

In this mode current outputs of all channels are connected in parallel (using the M133C-01 High Current Adapter). Current range is increased three times.

Output voltage terminals are on the main unit (Channel 1).

Power setting is the same as in modes Edc Basic a Eac Basic.

4.6 Generation of calibrated voltage

The calibrator can generate calibrated voltage. Output terminals for voltage ranges are VOLTAGE OUTPUT HI – LO terminals. Depending on the setting of the calibrator, voltage up to 600 V_{ef} can be present at the terminals.

Voltage setting range: 1 to 600 Vac, 1 to 280 Vdc

Control in the voltage mode

- Press “U” button on the calibrator and then select AC or DC mode by pressing „AC“ or „DC” button. The display shows the following data:
 - * main voltage value at VOLTAGE OUTPUT HI-LO terminals
 - * frequency, if AC voltage is selected
 - * uncertainty of voltage
- Set desired value of voltage using numeric keyboard, potentiometer or cursor buttons. Output voltage is not yet connected to the output terminals.
- Connect the instrument to be calibrated to VOLTAGE OUTPUT HI-LO.

- Press ON button.
- Green LED is lit above the “On” button to indicate the connection of output terminals.

Note: Read also chapter 4.3 Connection / disconnection of output terminals.

Overloading of output terminals

If the output terminals are overloaded or short-circuited in the voltage mode, the calibrator disconnects the signal from the output terminals and reports „Output Overload“.

Setting the voltage in modes Udc Basic and Uac Basic

The calibrator allows several ways of setting the value of generated voltage.

1. Setting the voltage

- Repeatedly press the “Sel” button (in the middle of cursor buttons) until the voltage value appears in edit mode (blue background).
- The value can be set using numeric keyboard and confirmed by pressing V softkey. The value can be set using cursor buttons or rotary knob as well.

2. Setting the frequency (AC voltage only)

- Repeatedly press the “Sel” button (in the middle of cursor buttons) until the frequency value appears in edit mode (blue background).
- The value can be set using numeric keyboard and confirmed by pressing Hz softkey. The value can be set using cursor buttons or rotary knob as well.

Note: Read also chapter 4.3 Connection / disconnection of output terminals.

4.7 Generation of calibrated current

The calibrator can generate calibrated current. Output terminals for current ranges are CURRENT OUTPUT HI – LO terminals.

Current setting range: 5 mA to 30 A

When 25/50-turn coil (option 140-50) is used, AC current range is to 1000 A.

Control in the current mode

- Press “I” button on the calibrator and then select AC or DC mode by pressing „AC“ or „DC” button. The display shows the following data:
 - * main current through the CURRENT OUTPUT HI-LO terminals
 - * frequency, if AC current is selected

* uncertainty of current

- Set desired value of current using numeric keyboard, rotary knob or cursor buttons. Output current is not yet connected to the output terminals.
- Connect the instrument to be calibrated to CURRENT OUTPUT HI-LO.
- Press ON button.
- Green LED is lit above the “On” button to indicate the connection of output terminals.
- If Coil x50 or Coil x25 function is activated (see below – Main menu), the optional current coil must be connected to the output terminals. The calibrator can be used to calibrate clamp Ameters up to 1500 A. The calibrator generates AC and DC current within the range up to 20 A with current coil.

Overloading of output terminals

When external circuit connected to current output terminals is disconnected or there is higher voltage at the load than permitted, the calibrator disconnects the output terminals and displays „Output Overload“ message. The same message can be displayed when 50-turn coil is used for AC current output at frequencies above 80 Hz. It depends on the set current and the type of ammeter connected.

Current modes (Mode softkey)

Output current can be generated in different current modes:

AC current

Mode	Name	Description
Basic	Iac Basic	AC current basic mode. Only first channel 1 is controlled in this mode.
High I	Iac High I	In this mode current outputs of all channels are connected in parallel (using the M133C-01 High Current Adapter). Current range is increased three times.

DC current

Mode	Name	Description
Basic	Idc Basic	DC current basic mode. Only first channel 1 is controlled in this mode.
High I	Idc High I	In this mode current outputs of all channels are connected in parallel (using the M133C-01 High Current Adapter). Current range is increased three times.

Use „Mode“ softkey to open the mode selection menu. Select the required mode using cursor buttons or the rotary knob. Confirm the selection by pressing the rotary knob or the “Select” softkey. Output terminals are disconnected if the new mode is selected.

Setting the current in modes Idc Basic and Iac Basic

The calibrator allows several ways of setting the value of generated current.

1. Setting the current

- Repeatedly press the “Sel” button (in the middle of cursor buttons) until the current value appears in edit mode (blue background).
- The value can be set using numeric keyboard and confirmed by pressing mA or A softkey. The value can be set using cursor buttons or rotary knob as well.

2. Setting the frequency (AC current only)

- Repeatedly press the “Sel” button (in the middle of cursor buttons) until the frequency value appears in edit mode (blue background).
- The value can be set using numeric keyboard and confirmed by pressing Hz softkey. The value can be set using cursor buttons or rotary knob as well.

Setting the current in modes Idc High I and Iac High I (Three phase version only)

In this mode current outputs of all channels are connected in parallel (using the M133C-01 High Current Adapter). Current range is increased three times.

Current setting is the same as in modes Idc Basic a Iac Basic.

5 Multimeter

The calibrator includes a built-in multimeter which can measure DC voltage, DC current and frequency. Measured signal must be connected to the “METER INPUT” terminals. Terminals mA, COM are for current measurements. Terminals V, COM are for voltage and frequency measurements.

The manufacturer does not recommend connection of multimeter inputs to calibrator outputs.

Such connection can result in presence of high voltage at multimeter inputs, which can damage the multimeter.

5.1 Function selection

- Measurement function should be selected in Main menu (item Meter).
- Press UP, DOWN display buttons or use the rotary knob to select one of the following functions:
 - * Voltage – DC voltage range 10V
 - * Current – DC current range 20mA
 - * Frequency – frequency range 10 kHz

Notes:

- * The multimeter can be used as a DC multimeter with ranges 10V and 20mA.
- * Frequency measurement is possible up to 15 kHz. Input signal must be within 0.2 to 5 V range. Square wave or pulse shape of the input signal is expected.

6 Calibrator setup menu (Main menu)

The calibrator allows many other, less frequently used parameters to be set. Setup menu is used to set these parameters. Setup menu is opened by pressing MENU button. If output terminals are connected, they will be disconnected and the following display appears:

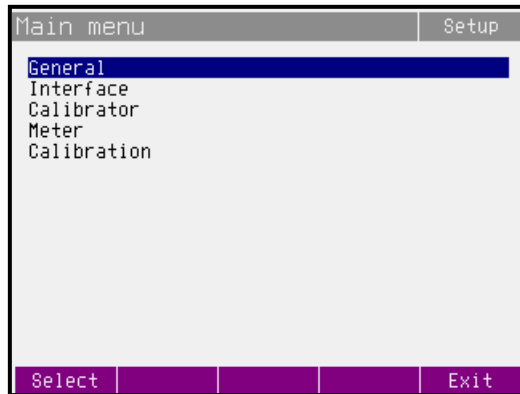

Use \wedge or \vee cursor button or the rotary knob to browse the menu options. Press „Select“ softkey or press in on the rotary knob to select highlighted item. Press „Exit“ softkey to leave the selected menu level.

New settings are retained when the calibrator is switched off.

The Main menu contains items:

- * General – general instruments settings (display, keyboard, time, date)
- * Interface – parameters of instruments remote control
- * Calibrator – parameters of signal generation
- * Meter – parameters of multimeter
- * Calibration – instruments calibration data

6.1 General Menu

Submenu contains basic parameters of display and keyboard.

1. Volume

This parameter sets the beeper volume. Cursor buttons, rotary knob or numeric keyboard allow to set the value in the range of 0 to 15. Press the Write softkey to set the beeper volume and return to the General menu.

2. Brightness

This parameter sets the display brightness. Cursor buttons, rotary knob or numeric keyboard allow to set the value in the range of 0 to 7. Press the Write softkey to set the display's brightness and return to the General menu.

3. *Beeper*

This parameter enables / disables the signalization of pressed key. Possible states are „Beep On“ and „Beep Off“. Press the Select softkey or press in on the rotary knob to set the selected state.

4. *Calibration Password*

This parameter sets the calibration password. Calibration password is a five-digit number, which must be entered to access the calibration mode. If the calibration password is set to 0, this information is displayed in the General menu. Other values are displayed as „Secret“.

You will be prompted to enter the present calibration password (use the numeric keyboard and press Enter). Now you can change the calibration password. Cursor buttons, rotary knob or numeric keyboard allow to set the value in the range of 0 to 99999. Press the Write softkey to set the display's brightness and return to the General menu.

Note: It is advisable to write down actual calibration code if changed. If you forget the calibration code, you have to send the calibrator to the manufacturer.

5. *Time*

Setting the real time. The parameter can be changed using cursor buttons, rotary knob or numeric keyboard.

6. *Date*

Setting the date. The parameter can be changed using cursor buttons, rotary knob or numeric keyboard.

7. *Device Information*

Viewing the device information. Displays the serial number and software version.

6.2 *Interface Menu*

Submenu contains remote control parameters.

1. *Active interface*

Sets the type of interface used to calibrator's remote control. By selecting an item from the list IEEE488, RS232 or Ethernet type can be selected. The calibrator can be remotely controlled only using the selected interface.

2. *IEEE488 address*

Sets the calibrator's IEEE488 (GPIB) address. Cursor buttons, rotary knob or numeric keyboard allow to set the value in the range of 0 to 30. Press the Write softkey to set the address and return to the Interface menu. Address 02 is set by the manufacturer.

3. *Baud rate*

Sets the communication speed of RS232 bus. By selecting an item from the list 1200, 2400, 4800, 9600, 19200, 38400, 76800 or 115200 Bd can be selected.

4. Ethernet settings

Unique fix IP address.

- * IP address
- * Local network mask
- * Local network gateway

6.3 Calibrator Menu

Submenu contains parameters that affect generated signal.

1. Voltage sources GND

This parameter allows to connect Lo terminals of all voltage channels to GND. In practice this means that Lo voltage terminals are grounded. By selecting an item from the list GndU Off and GndU On type can be selected.

2. Current sources GND

This parameter allows to connect Lo terminals of all current channels to GND. In practice this means that Lo current terminals are grounded. By selecting an item from the list GndI Off and GndI On type can be selected.

It is recommended to ground all output channels (GndU On, GndI On). If the meter to be calibrated has Lo terminal grounded, it is recommended to unground the corresponding calibrator's output to exclude ground loops.

Note

If neither the calibrator's output, nor the meter's inputs are grounded, signal/noise ratio can arise at the calibrator's output.

3. Phase unit

Sets the unit used for presentation the phase shift between the voltage and current output in the power and energy generation modes. By selecting an item from the list Deg (°) and Cos (Lead, Lag) unit can be selected.

4. Phase rotation

Phase rotation setting. By selecting an item from the list POS (standard phase) and NEG (reversed phase) rotation can be selected.

5. 280V range lock

- OFF position (default state)
140V range is used for values between 70.001V and 140.000V
280V range is used for values between 140.001V and 280.000V
- ON position
280V range is used for values between 70.001V and 280.000V

Feature is active for single harmonic modes only.

6. Current coil

Sets the calibrator for connection the 25/50-turn current coil (clamp ammeters calibration). The coil multiplies the output current either 25 times or 50 times depending on set parameter. By selecting an item from the list Coil Off, Coil x25 and Coil x50 type of connected current coil can be selected.

7. Synchronization

Sets the external synchronization of the output signal. By selecting an item from the list Internal (internal synchronization), Power line (synchronization to the power supply), External IN1 (synchronization to the passive signal on input 1 – output collector or relay contact), External IN2 (synchronization to the active signal on input 2) a External IN3 (synchronization to the active signal on input 3) type of frequency synchronization coil can be selected.

Note:

External synchronized signal has larger distortion than internal synchronized signal because of fine frequency tuning.

8. Active channels (Pac, Eac)

Sets the number of controlled channels in the three phase configuration. This parameter is valid only for Pac Basic and Eac Basic function modes. By selecting an item from the list 1 (output is from the main channel only), 1-2 (output from Channel 1 and Channel 2) and 1-2-3 (output from all three channels) number of used channels can be selected.

9. Harmonic components

Harmonic components can be entered in two ways:

- 1) % of RMS value
RMS value is constant (isn't changed by changing harmonic components value). New RMS value changes amplitude of all harmonic components.
- 2) % of fundamental
Fundamental value is constant (isn't changed by changing harmonic components value).
RMS value is changed by entering new harmonic components value.

10. Energy

Submenu contains parameters that affect Energy generation.

8.1. Energy units

Sets the unit used for energy. By selecting an item from the list Ws and Wh unit can be selected.

8.2. Energy - output

Contains parameters for setting the energy pulse output (BNC connector on the rear panel).

8.2.1. Internal pull-up

This parameter allows to connect the internal pull-up resistor (150 Ω) to the Energy pulse output.

8.2.2. Output constant

Contains parameters for definition the constant of Energy pulse output.

8.2.2.1. Value

This parameter sets number of pulses per selected unit (pulses generated on Energy pulse output on the rear panel BNC).

8.2.2.2. Unit

This parameter sets unit of Output constant value (pulses generated on Energy pulse output on the rear panel BNC).

8.3. Energy – input IN1

Contains parameters for setting the energy pulse input IN1.

8.3.1. Internal pull-up

This parameter allows to connect the internal pull-up resistor (150 Ω or 1 k Ω) to the Energy pulse input.

8.3.2. Input filter

This parameter allows to add input filter for contact debouncing. Input frequency with the input filter is limited to 400 Hz.

8.4. Maintain Voltage Signal

This parameter allows to maintain the voltage signal on test completion in energy counting modes (Packet / Counter / Timer).

11. Dip-Swell

Submenu contains parameters that affect Dip-Swell generation.

9.1. Dip-Swell repetition

Sets the repetition of Dip/Swell shape in P Dip/Swell mode. By selecting an item from the list One Shot (without repetition) and Repeat can be repetition selected. If Repeat is selected, Dip/Swell shape is generated after trigger repeatedly until disconnecting output terminals.

9.2. Dip-Swell synchronization

Sets the synchronization of Dip/Swell shape with internal phase 0°. By selecting an item from the list Sync Off and Sync On can be synchronization selected. If Sync Off is selected, Dip/Swell generation starts immediately after trigger. If Sync On is selected, Dip/Swell is synchronized with the internal phase 0° (channels with phase shift 0°).

9.3. Dip-Swell ext. trigger

Enables external triggering in P Dip/Swell mode. By selecting an item from the list Input Off and Input IN3 can be external trigger selected. If Input Off is selected, Dip/Swell generation can be started only internal (keyboard or remote control). If Input IN3 is selected, Dip/Swell generation can be started internal or by falling edge applied to the input IN3. The input must remain low for 10µs after the falling edge to be recognized properly.

6.4 Meter Menu

Submenu contains parameters that affect measured signal.

1. Function

Sets the internal multimeter measuring function and range. By selecting an item from the list Voltage (DC voltage 0-12V), Current (DC current 0-24mA) and Frequency (Frequency 1Hz-15kHz) function can be selected.

6.5 Calibration Menu

Calibration password is required to access the Calibration Menu. Default calibration password is „0”. For more detail about calibration see the chapter 7.

7 Calibration mode

The calibrator includes calibration procedure, which allows recalibration of the calibrator. Recalibration can be performed using the buttons and menu in the calibrator.

7.1 Calibration principles

The instrument can be calibrated:

- completely, i.e. all functions are calibrated in all recommended points
- partially, i.e. only selected functions are calibrated in all recommended points
- partially, i.e. only selected functions are calibrated in selected points

Complete calibration consists of all partial calibrations performed in the order defined by the calibration menu. If an item of the calibration menu, e.g. „Voltage DC#1” is selected, it is not necessary to calibrate all ranges defined by the calibration algorithm. If new calibration of all ranges is not possible (e.g. the required standard is not available), old calibration data can be confirmed, i.e. current step of the calibration can be skipped.

Calibration interruption can be performed in any point of the calibration procedure. However this particular calibration influences parameters of the calibrator.

Accuracy of the calibrator is guaranteed when full calibration was done.

AC voltage (Voltage AC#x) calibration is performed by setting 2 fixed points for all voltage ranges. The frequency is 55 Hz.

AC current (Current AC#x) calibration is performed by setting 2 fixed points for all current ranges. The frequency is 55 Hz.

DC voltage (Voltage DC#x) calibration is performed by setting 2 fixed points for all voltage ranges and for both polarities (+ and -).

DC current (Current DC#x) calibration is performed by setting 2 fixed points for all current ranges and for both polarities (+ and -).

AC modulation voltage (Voltage MOD#x, model M133C only) calibration is performed by setting 2 fixed points for all voltage ranges. The frequency is 55 Hz. This calibration values are used in P Harmonic and P Interharmonic function modes.

AC modulation current (Current MOD#x, model M133C only) calibration is performed by setting 2 fixed points for all current ranges. The frequency is 55 Hz. This calibration values are used in P Harmonic and P Interharmonic function modes.

Multimeter (Meter) calibration consist in calibration of ranges 10V DC, 20mA DC and 10 kHz.

7.2 Access to the calibration procedure

Calibration password is required to access the calibration procedure.

- Press Menu to open the Main menu.
- Select the Calibration submenu and press the „Select“ softkey.
- Calibrator requests the entry of the calibration password.

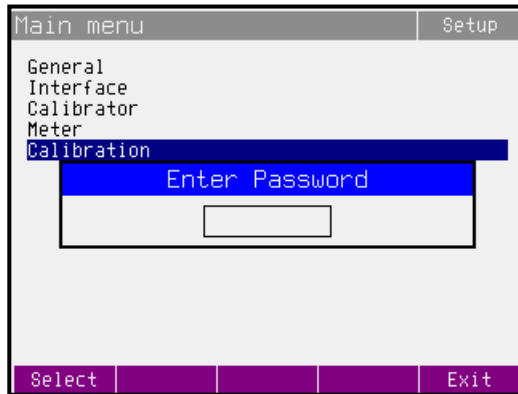

- Enter the correct calibration code using numeric keyboard and press ENTER.
- If incorrect calibration code is entered, an error message appears on the display for approximately 3 seconds:

Bad calibration code!

- If correct calibration code is entered, calibration menu with following list appears.

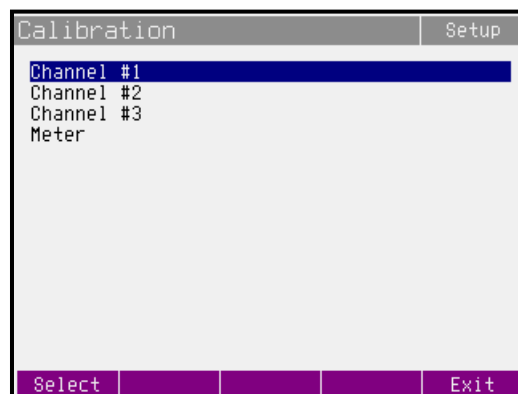

- Use \wedge and \vee cursor buttons to move the cursor through the list of calibration items.

1. Channel #1

Calibration data of the phase channel 1.

2. Channel #2

Calibration data of the phase channel 2.

3. Channel #3

Calibration data of the phase channel 3.

Every item from the list above has following submenu:

- Voltage AC# x - AC voltage calibration
- Current AC# x - AC current calibration
- Voltage DC# x - DC voltage calibration
- Current DC# x - DC current calibration
- Voltage MOD# x - AC voltage in modes P Harmonic a P Interharmonic calibration
- Current MOD# x - AC current in modes P Harmonic a P Interharmonic calibration

Where x is ordinal number of the phase unit (channel).

4. Meter

Calibration data of internal meter.

7.3 Selection of calibration type

After the calibration menu is displayed, one of partial calibrations can be selected. Use \wedge and \vee cursor buttons to move the cursor through the list. Having selected the required function to be calibrated, press Select softkey. The following data are shown (the following example is valid for Voltage AC#1):

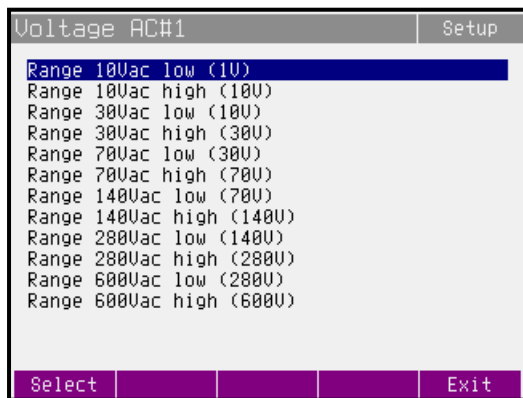

The table lists recommended calibration points. Having selected the required calibration point using Select softkey, the following data are shown.



Softkeys have the following meaning:

Write new calibration value is entered into the memory, old value is lost. The calibrator returns to the previous menu.

Skip current calibration step is skipped, old value is retained in the memory. The calibrator returns to the previous menu.

Moreover, the display shows the range which is being calibrated (Range 10Vac), and the value to be set at the external standard multimeter (value in brackets 1V).

Setting the new calibration data

Use cursor buttons, rotary knob or numeric keyboard to set such main data on the display, when the output signal measured by external standard multimeter reaches the required calibration point. When the standard output value is reached, press Write softkey to write new calibration value to the calibration memory. If you press Exit softkey, the calibrator ignores the new value and old value is retained.

The procedure is repeated for all calibration points of the selected function. If you press Exit softkey the calibrator returns back to the previous menu level.

Termination of calibration

Calibration can be terminated by repeated press the Exit softkey until the calibrator returns to the Main menu.

Calibration points

Each function of the calibrator has assigned fixed calibration points which have to be set during the calibration.

The calibrator needs no calibration of the following parameters:

- frequency
- phase relationship (power factor) of output voltage and current in AC power and AC energy generation modes
- DC and AC power and energy

Voltage AC function (Voltage AC#x)

Nominal value [V]	Set limits [V]	Range [V]
1	100 u	10
10	500 u	10
10	1 m	30
30	2 m	30
30	4 m	70
70	4 m	70
70	7 m	140
140	7 m	140
140	15 m	280
280	15 m	280
280	40 m	600
600	40 m	600

Table AC voltage

Current AC function (Current AC#x)

Nominal value[A]	Set limits [A]	Range [A]
30 m	10 u	300 m
300 m	15 u	300 m
300 m	30 u	1
1	50 u	1
1	100 u	2
2	100 u	2
2	200 u	5
5	250 u	5
5	500 u	10
10	500 u	10
10	1 m	30
30	1.5 m	30

Table AC current

Voltage DC function (Voltage DC#x)

Nominal value [V]	Set limits [V]	Range [V]
1	100 u	10
10	500 u	10
-1	100 u	-10
-10	500 u	-10
10	1 m	30
30	2 m	30
-10	1 m	-30
-30	2 m	-30
30	4 m	70
70	4 m	70
-30	4 m	-70
-70	4 m	-70
70	7 m	140
140	7 m	140
-70	7 m	-140
-140	7 m	-140
140	15 m	280
280	15 m	280
-140	15 m	-280
-280	15 m	-280

Table DC voltage

Current DC function (Current DC#x)

<i>Nominal value [A]</i>	<i>Set limits [A]</i>	<i>Range [A]</i>
30 m	10 u	300 m
300 m	15 u	300 m
-30 m	10 u	-300 m
-300 m	15 u	-300 m
300 m	30 u	1
1	50 u	1
-300 m	30 u	-1
-1	50 u	-1
1	100 u	2
2	100 u	2
-1	100 u	-2
-2	100 u	-2
2	200 u	5
5	250 u	5
-2	200 u	-5
-5	250 u	-5
5	500 u	10
10	500 u	10
-5	500 u	-10
-10	500 u	-10
10	1 m	30
30	1.5 m	30
-10	1 m	-30
-30	1.5 m	-30

Table DC current

Voltage AC modulation function (Voltage MOD#x)

<i>Nominal value [V]</i>	<i>Set limits [V]</i>	<i>Range [V]</i>
1	100 u	10
10	500 u	10
10	1 m	30
30	2 m	30
30	4 m	70
70	4 m	70
70	7 m	140
140	7 m	140
140	15 m	280
280	15 m	280

Table MOD AC voltage

Current AC modulation function (Current MOD#x)

<i>Nominal value[A]</i>	<i>Set limits[A]</i>	<i>Range [A]</i>
30 m	10 u	300 m
300 m	15 u	300 m
300 m	30 u	1
1	50 u	1
1	100 u	2
2	100 u	2
2	200 u	5
5	250 u	5
5	500 u	10
10	500 u	10
10	1 m	30
30	1.5 m	30

Table MOD AC current

Multimetr (Meter)

<i>Nominal value [-]</i>	<i>Set limits [-]</i>	<i>Range [-]</i>
0 V	50 u	10 V
10 V	200 u	10 V
0 mA	50 nA	20 mA
20 mA	500 nA	20 mA
10 kHz	200 mHz	10 kHz

Table Multimeter

7.4 Full calibration procedure

Required instruments

Following pages describe procedure of the full calibration. Following instruments are required for calibration:

- 8 1/2 digit multimeter type HP3458A or Fluke 8508A, or other type with accuracy 0.001 % on DC voltage
- Calibrator Meatest M142 or M140 with DC ranges 10V, 20mA a AC range 10V / 10kHz.
- Resistance shunt 10 mΩ, 100 mΩ Burster 1280, or other type with accuracy 0.01%
- Counter HP 53181A, HO 53130, BM 642 or other with accuracy 0,001 %
- Powermeter 0.02- 0.05 %, Zimmer LG95 or better

HP8903A Distortion analyzer and scope with bandwidth min. 20 MHz are recommended for THD measuring of AC signals.

Calibration procedure

1. Connect the calibrator and the multimeter to the mains and let them switched on for at least three hours in a laboratory at 23 ± 1 °C.
2. Press Menu button to call up the Main menu, select Calibration end press Select softkey to enter the calibration menu.
3. Enter the calibration code and press Enter button (default calibration code is "0").
4. **AC voltage ranges calibration**
 - a) Connect the voltage input terminals of the multimeter to the VOLTAGE OUTPUT HI - LO terminals of the calibrator.
 - b) Select Voltage AC#1 from the calibration menu and confirm by pressing Select softkey. Switch calibrator's output terminals ON.
 - c) Follow the instructions provided on the calibrator's display and the ACU table to adjust the calibrator's output in the calibration points.
 - d) To adjust the calibrator's output in the calibration points, press Select softkey and use <, >, v, ^ cursor buttons, rotary knob or numeric keyboard to adjust the output voltage. Confirm correctly set value by pressing Write softkey. If you want to skip the calibration point whose calibration you have already entered, press Exit softkey.
 - e) Switch output terminals OFF. Disconnect multimeter and calibrator.
 - f) Repeat steps a) to e) also for Voltage AC#2 and Voltage AC#3.

5. AC current ranges calibration

- a) Select Current AC#1 from the calibration menu and confirm by pressing Select softkey. Set the same function on external multimeter.
- b) Follow the instructions provided on the calibrator's display and the ACI table to adjust the calibrator's output in the calibration points.
- c) To adjust the calibrator's output in the calibration points, press Select softkey and use <, >, ∨, ∧ cursor buttons, rotary knob or numeric keyboard to adjust the output voltage. Confirm correctly set value by pressing Write softkey. If you want to skip the calibration point whose calibration you have already entered, press Exit softkey.
- d) Resistance shunt should be used on 2, 5, 10 and 30 A ranges, if standard multimeter does not cover this range.
- e) Repeat steps a) to d) also for Current AC#2 and Current AC#3.

6. DC voltage ranges calibration

- a) Select Voltage DC#1 from the calibration menu and confirm by pressing Select softkey. Switch calibrator's output terminals ON.
- b) Follow the instructions provided on the calibrator's display and the DCU table to adjust the calibrator's output in the calibration points.
- c) To adjust the calibrator's output in the calibration points, press Select softkey and use <, >, ∨, ∧ cursor buttons, rotary knob or numeric keyboard to adjust the output voltage. Confirm correctly set value by pressing Write softkey. If you want to skip the calibration point whose calibration you have already entered, press Exit softkey.
- d) Switch output terminals OFF. Disconnect multimeter and calibrator.
- e) Repeat steps a) to d) also for Voltage DC#2 and Voltage DC#3.

7. DC current ranges calibration

- a) Select Current DC#1 from the calibration menu and confirm by pressing Select softkey. Set the same function on external multimeter.
- b) Follow the instructions provided on the calibrator's display and the DCI table to adjust the calibrator's output in the calibration points.
- c) To adjust the calibrator's output in the calibration points, press Select softkey and use <, >, ∨, ∧ cursor buttons, rotary knob or numeric keyboard to adjust the output voltage. Confirm correctly set value by pressing Write softkey. If you want to skip the calibration point whose calibration you have already entered, press Exit softkey.
- d) Resistance shunt should be used on 2, 5, 10 and 30 A ranges, if standard multimeter does not cover this range.
- e) Repeat steps a) to d) also for Current DC#2 and Current DC#3.

8. AC voltage modulation ranges calibration (P Harmonic, P Interharmonic modes, model M133C only)

- a) Select Voltage MOD#1 from the calibration menu and confirm by pressing Select softkey. Switch calibrator's output terminals ON.
- b) Follow the instructions provided on the calibrator's display and the MOD ACU table to adjust the calibrator's output in the calibration points.
- c) To adjust the calibrator's output in the calibration points, press Select softkey and use <, >, ∨, ∧ cursor buttons, rotary knob or numeric keyboard to adjust the output voltage. Confirm correctly set value by pressing Write softkey. If you want to skip the calibration point whose calibration you have already entered, press Exit softkey.
- d) Switch output terminals OFF. Disconnect multimeter and calibrator.
- e) Repeat steps a) to d) also for Voltage MOD#2 and Voltage MOD#3.

9. AC current modulation ranges calibration (P Harmonic, P Interharmonic modes, model M133C only)

- a) Select Current MOD#1 from the calibration menu and confirm by pressing Select softkey. Set the same function on external multimeter.
- b) Follow the instructions provided on the calibrator's display and the MOD ACI table to adjust the calibrator's output in the calibration points.
- c) To adjust the calibrator's output in the calibration points, press Select softkey and use <, >, ∨, ∧ cursor buttons, rotary knob or numeric keyboard to adjust the output voltage. Confirm correctly set value by pressing Write softkey. If you want to skip the calibration point whose calibration you have already entered, press Exit softkey.
- d) Resistance shunt should be used on 2, 5, 10 and 30 A ranges, if standard multimeter does not cover this range.
- e) Repeat steps a) to d) also for Current MOD#2 and Current MOD#3.

10. Multimeter calibration

Built-in multimeter calibration consists of the calibration of 10 V voltage range, 20 mA current range and 10 kHz frequency range.

External calibrator of higher precision class should be used to calibrate the built-in multimeter (Meatest M142). If accurate external calibrator is not available an 8 1/2 digit multimeter is recommended for calibration.

- a) 10 V DC voltage range calibration
 - Select Meter from the calibration menu. Press Select softkey to select the first calibration point, 0 V.
 - Make short on calibrators input terminals METER INPUT V-COM.
 - Main value presents the calibration point. Leave value 0.000 and press Write softkey.
 - Select calibration point 10 V.

- Connect external voltage 10 V to the calibrator input terminals METER INPUT V-COM. Exact value can be measured by parallel standard voltmeter.
 - Adjust main value on the display. It should be equal to the value measured by standard multimeter. Use <, >, ∇, ^ cursor buttons, rotary knob or numeric keyboard to adjust the main value. Confirm new value by pressing Write softkey.
- b) 20 mA DC current range calibration
- Select Meter from the calibration menu. Press Select softkey to select the first calibration point, 0 mA.
 - Make short on calibrator's input terminals METER INPUT mA-COM.
 - Main value presents the calibration point. Leave value 0.000 and press Write softkey.
 - Select calibration point 20 mA.
 - Connect external current source 20 mA to the calibrator input terminals METER INPUT mA-COM. Exact value can be measured by serial standard ammeter.
 - Adjust main value on the display. It should be equal to the value measured by standard multimeter. Use <, >, ∇, ^ cursor buttons, rotary knob or numeric keyboard to adjust the main value. Confirm new value by pressing Write softkey.
- c) 10 kHz frequency range calibration
- Select calibration point 10 kHz.
 - Connect external AC voltage 10 kHz (voltage between 5 to 10 V) to the calibrator input terminals METER INPUT V-COM. Exact frequency value can be measured by parallel standard counter.
 - Adjust main value on the display. It should be equal to the value measured by standard counter. Use <, >, ∇, ^ cursor buttons, rotary knob or numeric keyboard to adjust the main value. Confirm new value by pressing Write softkey.

8 Error messages

If an error occurs during the calibrator's operation or control, error message is displayed on the display. Errors can be caused by:

- Incorrect control using the front panel, i.e. attempts to force a prohibited mode, e.g. setting an out-of-range value, overloading of output terminals etc.,

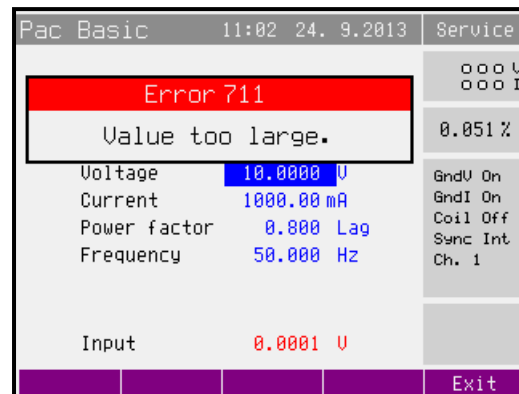

- Incorrect control using GPIB or RS-232 interface.
- Calibrator's fault.

Sample error message which appears when too large value is attempted to set up is shown below. All error messages are displayed in the frame overlapped main screen.

The following table lists all error messages, their meaning and simple troubleshooting.

<i>ID</i>	<i>Error message</i>	<i>Description</i>
-430	Deadlocked.	Remote interface error. A command was received which generates too much data to fit in the output buffer and the output buffer is full. Command execution continues but all data are lost.
-420	Unterminated.	Remote interface error. The calibrator was addressed to talk but a command has not been received which sends data to the output buffer.
-410	Interrupted.	Remote interface error. A command was received which sends data to the output buffer, but the output buffer contained data from a previous command. The output buffer is cleared when power has been off, or after reset command has been executed.
-363	Input buffer overrun	Remote interface error.
-220	Invalid parameter	Remote interface error. An invalid character string was received. Check to see if you have enclosed the character string in single or double quotes and that the string contains valid ASCII character.
-140	Character data	Remote interface error. Received command doesn't

		contain valid character parameter.
-120	Numeric data	Remote interface error. Received command doesn't contain valid numeric parameter.
-110	Command header	Remote interface error. Received command isn't valid.
501	Eeprom write.	Eeprom write failed.
502	Eeprom read.	Eeprom read failed.
503	Eeprom error.	Eeprom data lost. Check calibration data.
701,704	Output overload	Output signal over specified limits. Decrease signal level or decrease the load.
703	High temperature	Calibrator power stage overheated. Disconnect external load. Ambient temperature is too high or forced ventilation holes are blocked.
705	Input overload	Input signal over specified limits. Decrease signal level.
706	Current output overload	Current output terminals overloaded. Decrease signal level or decrease the load.
707	Voltage output overload	Voltage output terminals overloaded. Decrease signal level or decrease the load.
722	Unexpected crossing.	Error in internal communication.
721	Unknown function.	Error in internal communication.
730, 731	Calibrator not ready	Error in internal communication.
732	Internal cpu RESET	Calibrator will be restarted.
743	Interface receive	Error in internal communication.
745	Internal CPU timeout	Error in internal communication.
746, 747, 748	Slave error	Error in internal communication.
750	Harmonic U#1 over range	Amplitude of harmonic signal on voltage channel #1 is too high. Reduce amplitudes of individual harmonic components.
751	Harmonic U#2 over range	Amplitude of harmonic signal on voltage channel #2 is too high. Reduce amplitudes of individual harmonic components.
752	Harmonic U#3 over range	Amplitude of harmonic signal on voltage channel #3 is too high. Reduce amplitudes of individual harmonic components.
753	Harmonic I#1 over range	Amplitude of harmonic signal on current channel #1 is too high. Reduce amplitudes of individual harmonic components.
754	Harmonic I#2 over range	Amplitude of harmonic signal on current channel #2 is too high. Reduce amplitudes of individual harmonic components.
755	Harmonic I#3 over range	Amplitude of harmonic signal on current channel #3 is too high. Reduce amplitudes of individual harmonic components.
770	Function not available.	Selected function is not available for this device (higher harmonic components are not available for M133Ci).

9 Maintenance

The multifunction calibrator is electronic instrument with microprocessor control. All blocks which are heavily loaded during the operation are cooled by a fan.

Rules for correct operation

Especially the following rules should be adhered to guarantee correct operation of the calibrator:

- *The calibrator can only be switched on and off by pressing the mains switch located at the rear panel.*
- *Do not connect the calibrator to other voltage than set by the voltage selector.*
- *Do not block the vent openings located at the rear panel and bottom panel.*
- *The calibrator must not be operated in dusty environment. It was designed to be used in a laboratory.*
- *No liquid or small objects can be permitted to enter the calibrator through the vent openings..*
- *Do not switch the calibrator outside its operating temperature range.*
- *Connect the instruments to be calibrated to proper output terminals. There is no way of protecting the calibrator from the damage caused by some improper connections.*
- *Do not damage the output terminals by plugging in “bananas” thicker than the terminals were designed for.*
- *Whenever possible, use the setup menu to ground Lo output terminals (GndU On, GndI On).*
- *Do not overload the power stages by leaving the calibrator switched on with the load connected for a long time, especially on 30 A current range and 140 V and 280 V voltage ranges.*
- *If the instruments to be calibrated are not connected to calibrator’s output terminals using original cables, ensure that cables suitable for the calibration voltage and current are used. Maximum output voltage can reach 600 V AC and the maximum output current can reach 30 A AC.*

Regular maintenance

The calibrator does not require any special maintenance of electrical or mechanical parts. If it gets dirty, the case and the display can be cleaned by a wool rag moistened with alcohol.

The calibrator should be calibrated in the recommended 12-month intervals. A calibration center should perform the calibration.

What to do in case of failure

If an **obvious failure** occurs during the operation (e.g. the display is not lit, the fan is not turning), the calibrator must be switched off immediately. First, check the fuse located in the power cord receptacle. Procedure is following:

- Remove the end of power cord from the mains connector at the rear panel.
- Insert the blade of a flat screwdriver into the opening cut in the mains voltage selector and pry out the fuse holder.
- Remove the fuse. Replace it with new fuse of the same rating if the fuse was broken.
- Replace the fuse holder, reconnect the power cord and switch on the calibrator. If the problem persists, contact the manufacturer.

If an obvious fault is evidenced, e.g. a measurement range or an operating mode is not functional, the user cannot correct the fault. Contact the manufacturer.

Hidden faults can cause different symptoms and be caused by different causes. Usually, they cause instability of some parameter. Hidden defects can be caused by unacceptable distortion, degraded insulation etc. In this case contact the manufacturer.

Sometimes it seems that the calibrator has hidden defect, when the rules for correct operation are not adhered to. In this case, the fault is caused by the operator. Most frequent cases of false “hidden defects”:

- mains voltage out of tolerance limits or unstable
- wrong grounding of the measurement circuit (bad connection of the ground terminal of the mains outlet, or several ground connection when grounding loops are formed)
- proximity to sources of intensive influence, whose products are spread through the mains or propagated by the electromagnetic field
- strong electrostatic or electromagnetic field which can cause major instability during calibration using higher impedance.

10 Verification test

Procedure recommended for verifying parameters of the calibrator is described in this chapter. During tests it is not necessary access to the interior of the instrument.

Required equipment

Following instruments are required for performance verification test:

- 8 1/2 digit multimeter type HP3458A or Fluke 8508A, or other type with accuracy 0.01 % on AC voltage
- Multifunction calibrator MEATEST M142 or M140 with DC ranges 10V, 20mA and AC range 10V / 15kHz.
- resistance shunt 10 m Ω , 100 m Ω Burster 1280, or other type with accuracy 0.01% with known AC/DC difference to 1 kHz
- counter HP 53181A, HO 53130, BM 642 or other with accuracy 0,001 %
- powermeter 0.02- 0.05 % like Zimmer LMG95REF, Applied Precision RS2110S

HP8903A Distortion analyzer and scope with bandwidth min. 20 MHz. 100 kHz bandwidth is recommended for THD measuring of AC signals.

Configuration of the calibrator

Calibrator should be tested directly from the front panel terminals. To suppress influence of noise or interference with power line frequency in measuring circuit it is recommended following setting of the calibrator (in Main menu):

- | | |
|-------------------------------|-----------------|
| 1. <i>Current coil</i> | <i>Coil Off</i> |
| 2. <i>Voltage sources GND</i> | <i>GndU On</i> |
| 3. <i>Current sources GND</i> | <i>GndI On</i> |

Note: If it is grounded neither calibrator nor standard meter, higher level can occur on the output terminals.

In general, when calibrator is connected to the standard meter, ground loops can be arise through power line connection. Ground loops can result apparently worse noise, short term stability or non-harmonic distortion of output signal. If necessary use toroidal chokes to suppress this products.

Use sin waveform of the output signal on all AC tests.

Performance verification may be performed after warm-up period i.e. 1 hour after switching on. Calibrator have to be in temperature stabilize condition at minimum 8 hours before performance verification test is started.

Basic steps of the performance verification test

Verification procedure consists of following steps:

- **30 V DC voltage** test with linearity check
- **DC voltage** internal ranges 10 V, 70 V, 140 V, 280 V test
- **30 V AC voltage** test with linearity check
- **AC voltage** internal ranges 10 V, 70 V, 140 V, 280 V, 600 V test
- **1 A DC current** test with linearity check
- **DC current** internal ranges 300 mA, 2 A, 5 A, 10 A, 30 A test
- **AC current** internal ranges 300 mA, 2 A, 5 A, 10 A, 30 A test
- **AC/DC power** 480W, 2400W (AC power with PF 0, +0.5, -0.5) test
- **Frequency** nominal value 1 kHz test
- **Multimeter** internal ranges 10 VDC, 20 mADC, frequency 10 kHz test
- **Distortion** checking of AC voltage, range 30 V.

Procedure

Following part describes procedure of performance verification test. Recommended measuring points are the same as the points in table of limits (see tables bellow).

1. Connect the calibrator to the mains and let them switched on for at least one hour in a laboratory at 23 ± 1 °C.
2. Connect voltage input of the standard multimeter to the voltage output terminals of the calibrator. Set appropriate parameters on the standard multimeter to achieve its best accuracy.
3. Perform 30 VDC linearity, DC voltage, 30 VAC linearity, AC voltage tests according to the tables I, II, III, IV. Deviations should not exceed specified limits.
4. Connect current input of standard multimeter to the current output terminals of the calibrator. Set appropriate parameters on the standard multimeter to meet its best accuracy.
5. Perform 1 ADC linearity, DC current, AC current tests according to the tables V, VI, VII. Deviations should not exceed specified limits.
6. Connect standard powermeter to the appropriate output and current terminals of the calibrator.
7. Perform AC/DC power test according to the table VIII. Deviations should not exceed specified limits.
8. Connect output voltage terminals of the calibrator to the counter. Set output voltage 5 VAC, frequency 1 kHz.

9. Perform frequency test according to the table IX. Deviation should not exceed specified limit.
10. Connect input voltage terminals of calibrator's internal multimeter to the output terminals of the standard calibrator. Set appropriate value of frequency and DC voltage according to the table X.
11. Perform multimeter test in points FREQUENCY 10000Hz and 10 VDC. Deviations should not exceed limits in the tables bellow.
Note : Because accuracy of calibrator output is not accurate enough in all points, use external standard counter (frequency) or multimeter (DC voltage) connected in parallel to the output terminals to obtain exact value on the output.
12. Connect input current terminals of calibrator's internal multimeter to the output terminals of the standard calibrator. Set appropriate value of DC current according to the table X.
13. Perform multimeter test on range 20 mA DC according to the table X. Deviation should not exceed specified limit.
14. Connect distortion meter to the voltage output terminals of the calibrator. Set output voltage 10 VAC, frequency 1000 Hz and sin waveform.
15. Check harmonic distortion of output signal. It should not exceed 0.05%.

If calibrator is out of limits is in some points of this test, appropriate function and range should be recalibrated. It is not necessary to recalibrate all functions, but only this one, which does not meet specification. See chapter Calibration mode, where recalibration procedure is described.

Tables of limits**30 V DC Basic range with linearity test**

Function	Range	Value (V)	Frequency (Hz)	Deviation allowed (mV)
V-DC	30.0 V	12.0		4.8
V-DC	30.0 V	14.0		5.1
V-DC	30.0 V	16.0		5.4
V-DC	30.0 V	18.0		5.7
V-DC	30.0 V	20.0		6.0
V-DC	30.0 V	22.0		6.3
V-DC	30.0 V	24.0		6.6
V-DC	30.0 V	26.0		6.9
V-DC	30.0 V	28.0		7.2
V-DC	30.0 V	30.0		7.5
V-DC	30.0 V	-12.0		4.8
V-DC	30.0 V	-14.0		5.1
V-DC	30.0 V	-16.0		5.4
V-DC	30.0 V	-18.0		5.7
V-DC	30.0 V	-20.0		6.0
V-DC	30.0 V	-22.0		6.3
V-DC	30.0 V	-24.0		6.6
V-DC	30.0 V	-26.0		6.9
V-DC	30.0 V	-28.0		7.2
V-DC	30.0 V	-30.0		7.5

Table I

DC voltage test

Function	Range	Value (V)	Frequency (Hz)	Deviation allowed (mV)
V-DC	10.0 V	10.0		2.5
V-DC	10.0 V	-10.0		2.5
V-DC	70.0 V	70.0		17.5
V-DC	70.0 V	-70.0		17.5
V-DC	140.0 V	140.0		35.0
V-DC	140.0 V	-140.0		35.0
V-DC	280.0 V	280.0		70.0
V-DC	280.0 V	-280.0		70.0

Table II

30 V AC Basic range with linearity test

Function	Range	Value (V)	Frequency (Hz)	Deviation allowed (mV)
V-AC	30.0 V	12.0	55	4.8
V-AC	30.0 V	14.0	55	5.1
V-AC	30.0 V	16.0	55	5.4
V-AC	30.0 V	18.0	55	5.7
V-AC	30.0 V	20.0	55	6.0
V-AC	30.0 V	22.0	55	6.3
V-AC	30.0 V	24.0	55	6.6
V-AC	30.0 V	26.0	55	6.9
V-AC	30.0 V	28.0	55	7.2
V-AC	30.0 V	30.0	55	7.5

Table III

AC voltage test

Function	Range	Value (V)	Frequency (Hz)	Deviation allowed (mV)
V-AC	10 V	10.0	55	2.5
V-AC	30 V	30.0	20	9.0
V-AC	30 V	30.0	55	7.5
V-AC	30 V	30.0	120	9.0
V-AC	30 V	30.0	1000	9.0
V-AC	70 V	70.0	55	17.5
V-AC	140 V	140.0	55	35.0
V-AC	280 V	280.0	55	70.0
V-AC	600 V	600.0	55	180.0

Table IV

1 A DC Basic range with linearity test

Function	Range	Value (A)	Frequency (Hz)	Deviation allowed (μ A)
A-DC	1 A	0.4		200
A-DC	1 A	0.5		225
A-DC	1 A	0.6		250
A-DC	1 A	0.7		275
A-DC	1 A	0.8		300
A-DC	1 A	0.9		325
A-DC	1 A	1.0		350
A-DC	1 A	-0.4		200
A-DC	1 A	-0.5		225
A-DC	1 A	-0.6		250
A-DC	1 A	-0.7		275
A-DC	1 A	-0.8		300
A-DC	1 A	-0.9		325
A-DC	1 A	-1.0		350

Table V

DC current test

Function	Range	Value (A)	Frequency (Hz)	Deviation allowed (μ A)
A-DC	300.0 mA	0.3		105 μ
A-DC	300.0 mA	-0.3		105 μ
A-DC	2.0 A	2.0		700 μ
A-DC	2.0 A	-2.0		700 μ
A-DC	5.0 A	5.0		1.75 m
A-DC	5.0 A	-5.0		1.75 m
A-DC	10.0 A	10.0		4.5 m
A-DC	10.0 A	-10.0		4.5 m
A-DC	30.0 A	30.0		15.0 m
A-DC	30.0 A	-30.0		15.0 m

Table VI

AC current test

Function	Range	Value (A)	Frequency (Hz)	Deviation allowed (μ A)
A-AC	300.0 mA	0.3	55	105 μ
A-AC	1.0 A	1.0	55	350 μ
A-AC	1.0 A	1.0	800	500 μ
A-AC	2.0 A	2.0	55	800 μ
A-AC	5.0 A	5.0	55	1.75 m
A-AC	10.0 A	10.0	55	4.5 m
A-AC	30.0 A	30.0	55	15.0 m

Table VII

AC/DC power test

Function	Range	Value (W)	Frequency (Hz)	Deviation allowed (W)
P 1	480W	480	55	0.216
P 0,5LA	480W	240	55	0.180
P 0,5LE	480W	240	55	0.180
P 1	2400W	2400	55	1.27
P 0,5LA	2400W	1200	55	0.972
P 0,5LE	2400W	1200	55	0.972

Table VIII

Voltage = 240V

Frequency test

Function	Range	Value (Hz)	Frequency (Hz)	Deviation allowed (Hz)
FREQ	10 kHz	10000.0		0.5

Table IX

Multimeter test

Function	Range	Value	Frequency (Hz)	Deviation allowed
FREQ	10 kHz	10000.0 Hz		0.5 Hz
V-DC	10 V	10.0 V		1.3 mV
V-DC	10 V	-10.0 V		1.3 mV
A-DC	20 mA	0.02 A		3.3 μ A
A-DC	20 mA	-0.02 A		3.3 μ A

Table X

11 System control

The calibrator is equipped with RS232 serial line, IEEE488 bus and the TCP/IP Ethernet connection. System connectors are located at the rear panel. For the remote control to work properly, interface parameters must be set in the system menu. For RS232 line communication speed can be set (1200 to 115200 Bd). For IEEE488 bus, an address from range 0 to 30 is allowed. For Ethernet connection can be set IP address. The calibrator can be only controlled by one of interfaces at a time. It is therefore necessary to select one of the interfaces (RS232/Ethernet/IEEE488) using the system menu.

11.1 IEEE488 bus properties

The instrument performs the following functions based on IEEE488 bus commands:

SH1, AH1, T5, L3, RLI, DC1, SRI

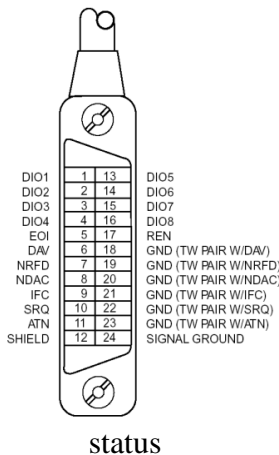

status

The instrument also recognizes the following general commands:

DCL	Device Clear	reset the calibrator
SDC	Selected Device Clear	reset the calibrator
EOI	End or Identify Message Terminator	close the message
GTL	Go To Local	close remote control mode
LLO	Local Lock Out	local control locked
SPD	Serial Poll Disable	close serial message status
SPE	Serial Poll Enable	release serial message

11.2 RS232 serial line setting

To transfer the data using RS232 bus, 8N1 data format is used, i.e. each data word includes 8 bits, no parity and one stop bit. The communication speed can be set using the system menu. Available values: 1200, 2400, 4800, 9600, 19200, 38400, 76800 and 115200 Bd.

RS-232 connector layout

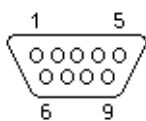

Pin	Name	Direction	Description
2	TXD	Output	Transmitter
3	RXD	Input	Receiver
5	GND	-	Ground

9-pin connector D-SUB FEMALE

Cable between the calibrator and PC (configuration 1:1)

PC	D-Sub 1	D-Sub 2	Calibrator
Receiver	2	2	Transmitter
Transmitter	3	3	Receiver
Ground	5	5	Ground

Note:

It is not possible to send or receive data over RS232 or Ethernet when the calibrator is not in remote mode.

You should use the command SYST:REM or SYST:RWL.

11.3 Command syntax

The commands described in this chapter can be issued through all buses (RS232/Ethernet/IEEE488).

All commands listed in this chapter are explained in two columns:
KEYWORD and PARAMETERS.

KEYWORD column includes the name of the command. Each command includes one or more keywords. If a keyword is in brackets ([]), it is not mandatory. Non-mandatory commands are used only to achieve compatibility with language standard SCPI.

Capitals designate the abbreviated form of the commands; extended form is written in lowercase.

Command parameters are in brackets (<>); each parameter is separated using a comma. Parameters in brackets ([]) are not mandatory. Line (|) means “or” and is used to separate several alternative parameters.

Semicolon ‘;’ is used to separate more commands written on one line.
E.g. :SAF:LR 100.5;:OUTP ON

Note (only for RS232 and Ethernet):

Each command must end in <cr> or <lf>. Both codes <crlf> can be used at the same time. The calibrator performs all commands written on one line of the program after it receives <cr>, <lf> or <crlf> code. Without this code, the program line is ignored.

Description of abbreviations

<DNPD> = Decimal Numeric Program Data, this format is used to express decimal number with or without the exponent.

<CPD> = Character Program Data. Usually, it represents a group of alternative character parameters. E.g. {ON | OFF | 0 | 1}.

<SPD> = String Program Data. String value consisting from more parts. It is used for date/time setting.

- ? = A flag indicating a request for the value of the parameter specified by the command. No other parameter than the question mark can be used.
- (?) = A flag indicating a request for the parameter specified by the command. This command permits a value to be set as well as requested.
- <cr> = carriage return. ASCII code 13. This code executes the program line.
- <lf> = line feed. ASCII code 10. This code executes the program line.

INPut subsystem

This subsystem enables to change parameters of calibrator inputs.

Keyword	Parameters
INPut	
:FILTer (?)	<CPD> { OFF ON 0 1 }
:PULLup (?)	<CPD> { OFF 150 1K }

INP:FILT (?) <CPD> { OFF | ON | 0 | 1 }

This command connects the internal filter to the IN1.

- OFF or 0 – disconnects filter (frequency range 0 to 1 MHz)
- ON or 1 – connects filter (frequency range 0 to 400 Hz)

State of the function remains valid even after the calibrator is switched off and back on.

If query is sent, calibrator returns state of the function { 0 | 1 }.

INP:PULL (?) <CPD> { OFF | 150 | 1K }

This command connects the internal pull-up resistor (150 Ω or 1 k Ω) to the IN1.

- OFF – disconnects pull-up resistor
- 150 – connects pull-up resistor (150 Ω)
- 1K – connects pull-up resistor (1k Ω)

State of the function remains valid even after the calibrator is switched off and back on.

If query is sent, calibrator returns connects resistor { OFF | 150 | 1K }.

OUTPut subsystem

This subsystem enables to activate or deactivate the calibrator output.

Keyword	Parameters
OUTPut	
[:STATe](?)	<CPD> { ON OFF }
:LOWVoltage(?)	<CPD> { FLOat GROund }
:LOWCurrent (?)	<CPD> { FLOat GROund }
[:PHASe]:UNIT(?)	<CPD> { DEG COS }
:CURCoil(?)	<CPD> { OFF X25 X50 }
:SYNChronization(?)	<CPD> { INT LINE IN1 IN2 IN3 }
:LOCKed?	<CPD> { 0 1 }
:ENERgy	
:UNIT(?)	<CPD> { WS WH }
:MVOltage(?)	<CPD> { OFF ON 0 1 }

```

:REFerence
  :UNIT(?)          <CPD> { W | VA | VAR }
  :PULLup(?)       <CPD> { 0 | 1 }
  :CONStant(?)     <DNPD>
:MHARmonics
  :UNIT(?)          <CPD> { PRMS | PFUN }
:CONFIguration(?) <CPD> { 1 | 12 | 123 }
:L280(?)           <CPD> { OFF | ON | 0 | 1 }

```

OUTP[:STAT](?) <CPD> { ON | OFF }

This command activates or deactivates output terminals.

- ON - activates the output
- OFF - deactivates the output

If query is sent, calibrator returns ON if the output is active or OFF if it is inactive

Example: OUTP ON - activates the output
 OUTP? - the calibrator returns ON or OFF

OUTP:LOWV(?) <CPD> { FLO | GRO }

This command connects or disconnects the Lo terminals of all voltage outputs to/from GND terminal.

- FLOat ungrounds voltage outputs
- GROund grounds voltage outputs

If query is sent, calibrator returns GRO when the output is grounded or FLO when floating.

Example: OUTP:LOWV GRO
 OUTP:LOWV? Calibrator returns FLO or GRO

OUTP:LOWC(?) <CPD> { FLO | GRO }

This command connects or disconnects the Lo terminals of all current outputs to/from GND terminal.

- FLOat ungrounds current outputs
- GROund grounds current outputs

If query is sent, calibrator returns GRO when the output is grounded or FLO when floating.

Example: OUTP:LOWC GRO
 OUTP:LOWC? Calibrator returns FLO or GRO

OUTP[:PHAS]:UNIT(?) <CPD> { DEG | COS }

This command sets the method used to specify the phase shift between the output voltage and current.

- DEG activates a mode where all entries are done using the angle, „°“ in the range of 0.0 – 360.0°
- COS activates a mode where all entries are done using the power factor in the range of 1.000 to –1.000, LAG or LEAD (LAG = 0-180°, LEAD = 180-360°)

The unit of measurement remains valid even after the calibrator is switched off and back on.

If query is sent, calibrator returns the set unit of measurement { DEG | COS }.

Example: OUTP:UNIT DEG <cr> - sets the angle as the unit of phase shift
 OUTP:UNIT? <cr> - the calibrator returns DEG

OUTP:CURC(?) <CPD> { OFF | X25 | X50 }

This command activates or deactivates the use of 25 or 50-turns current coil.

- OFF - deactivates the current coil
- X25 - activates the 25 turns current coil
- X50 - activates the 50 turns current coil

If query is sent, calibrator returns X50 if the 50-turn coil is activated X25 if the 25-turn coil is activated or OFF if the current coil is deactivated.

Example: OUTP:CURC X50 activates 50-tuen current coil
 OUTP:CURC? Calibrator returns OFF, X50 or X25

OUTP:SYNC(?) <CPD> { INT | LINE | IN1 | IN2 | IN3 }

This command sets mode of output frequency synchronization.

- INT – internal synchronization
- LINE – synchronization to power supply frequency
- IN1 – synchronization to external signal (input IN1)
- IN2 – synchronization to external signal (input IN2)
- IN3 – synchronization to external signal (input IN3)

If query is sent, calibrator returns INT, LINE, IN1, IN2 or IN3 according to selected synchronization mode.

Example: OUTP:SYNC INT selects frequency synchronization to internal reference
 OUTP:SYNC? Calibrator returns INT, LINE, IN1, IN2 or IN3

OUTP:SYNC:LOCK? <CPD> { 0 | 1 }

This query returns the actual state of frequency synchronization.

- 0 – output frequency is not locked (it is not possible to activate the output terminals)
- 1 – output frequency is locked to reference signal

Example: OUTP:SYNC:LOCK? calibrator returns 1 or 0

OUTP:ENER:UNIT(?) <CPD> { WS | WH }

This command sets unit used for energy.

- WS - energy is displayed in Ws, VAs, VArh
- WH - energy is displayed in Wh, VAh, VAh

Energy unit remains valid even after the calibrator is switched off and back on.

If query is sent, calibrator returns set energy unit { WS | WH }.

Example: OUTP:ENER:UNIT WH <cr> - sets energy unit Wh
 OUTP: ENER:UNIT? <cr> - the calibrator returns WH

OUTP:ENER:MVOL(?) <CPD> { OFF | ON | 0 | 1 }

This command activates or deactivates Maintain Voltage Signal function.

- OFF or 0 – function is not active
- ON or 1 – function is active

State of the function remains valid even after the calibrator is switched off and back on.

If query is sent, calibrator returns state of the function { 0 | 1 }.

Example: OUTP:ENER:MVOL ON <cr> - activates Maintain Voltage Signal function
 OUTP: ENER:MVOL? <cr> - the calibrator returns 1

OUTP:REF:PULL (?) <CPD> { 0 | 1 }

This command connects the internal pull-up resistor (150 Ω) to the Energy pulse output.

- 0 disconnects pull-up resistor
- 1 connects pull-up resistor

If query is sent, calibrator returns 0 or 1.

Example: OUTP:REF:PULL 1 connects pull-up resistor
 OUTP:REF:PULL? calibrator returns 0 or 1

OUTP:REF:CONS(?) <DNPD>

This command sets number of pulses per selected unit (pulses generated on Energy pulse output on the rear panel BNC).

<DNPD>

Parameter represents the value number of pulses per selected unit.

If query is sent, calibrator returns set value using standard exponential format. Example: 400.0 i/kWh is returned as 4.000000e+002.

Example:

Number of pulses 1000 i/kVAh:
 OUT:REF:CONS 1000.0
 OUT:REF:UNIT VAR

OUTP:REF:UNIT(?) <CPD> { W | VA | VAR }

This command defines unit of constant for pulses generated on Energy pulse output.

<CPD>

If query is sent, calibrator returns selected unit.

Example: OUTP:REF:UNIT VAR <cr> - sets energy pulse output unit VAR
 OUTP: REF:UNIT? <cr> - the calibrator returns VAR

OUTP:MHAR:UNIT(?) <CPD> { PRMS | PFUN }

This command defines how are evaluated higher harmonic components.

<CPD>

- PRMS – % of RMS value
- PFUN – % of Fundamental harmonic value

If query is sent, calibrator returns selected unit.

Example: OUTP:MHAR:UNIT PRMS <cr> - harmonics are expressed as “% of RMS”
 OUTP: MHAR:UNIT? <cr> - the calibrator returns PRMS

OUTP:CONF (?) <CPD> { 1 | 12 | 123 }

This command defines how many outputs is used in basic power and energy AC modes (Pac and Eac).

- 1 – active are channels U1, I1 only
- 12 – active are channels U1, U2, I1, I2
- 123 – active are all channels

If query is sent, calibrator returns active channels.

Example: OUTP:CONF 123 <cr> - activates all channels
 OUTP: CONF? <cr> - the calibrator returns 123

OUTP:L280(?) <CPD> { OFF | ON | 0 | 1 }

This command activates or deactivates „280V range lock” function.

- OFF or 0 – 280V range is not locked
- ON or 1 – 280V range is locked

State of the function is switched off after power on.

If query is sent, calibrator returns state of the fuction { 0 | 1 }.

Example: OUTP:L280 ON <cr> - lockes 280V range
 OUTP:L280? <cr> - the calibrator returns 1

MEASure a CONFigure subsystem

This subsystem allows controlling the internal multimeter.

Keyword	Parameters
---------	------------

MEASure?

CONFigure(?) <CPD> { VOLTage | CURRent | FREQuency }

MEAS?

This query returns value measured by the multimeter.

calibrator returns the set value of power using standard exponential format. Example: 5.456 V is returned as 5.456000e+000.

Example: MEAS? Calibrator returns measured value

CONF(?) <CPD> { VOLT | CURR | FREQ }

This command sets the function of internal multimeter.

If query is sent, calibrator returns VOLT, CURR or FREQ according to selected multimeter function.

Example: CONF VOLT sets the multimeter to function voltage DC

SOURCE subsystem

This subsystem allows controlling the individual functions of the calibrator.

Keyword	Parameters
---------	------------

[SOURCE]

:MODE? { PAC | PDC | PACI | PDCI | PACE | PHAR | PIH | PDIP | PDCE | EAC | EDC |
EACI | EDCI | VAC | VDC | CAC | CDC | CACI | CDCI }

:PAC

:POWER(?) <DNPD>

[:POWER]

:UNIT(?) <CPD> { W | VA | VAR }

:VOLTage(?) <DNPD>

:CURRent(?) <DNPD>

[:CURRent]

:PHASe(?) <DNPD>

:POLarity(?) <CPD> { LEAD | LAG }

:FREQuency(?) <DNPD >

:PDC

:POWER(?) <DNPD>

:VOLTage(?) <DNPD>

:CURRent(?) <DNPD>

:PACI

:POWER(?) <DNPD>

[:POWer]	
:UNIT(?)	<CPD> { W VA VAR }
:VOLTage(?)	<DNPd>
:CURRent(?)	<DNPd>
[:CURRent]	
:PHASe(?)	<DNPd>
:POLarity(?)	<CPD> { LEAD LAG }
:FREQuency(?)	<DNPd >
:PDCI	
:POWer(?)	<DNPd>
:VOLTage(?)	<DNPd>
:CURRent(?)	<DNPd>
:PACE	
:POWer?	
[:POWer]	
:UNIT(?)	<CPD> { W VA VAR }
:VOLTage<n>(?)	<DNPd>
:PHASe(?)	<DNPd>
:ENABle (?)	<CPD> { ON OFF }
:CURRent<n>(?)	<DNPd>
:PHASe(?)	<DNPd>
:ENABle (?)	<CPD> { ON OFF }
:FREQuency(?)	<DNPd >
:PDCE	
:POWer?	
:VOLTage<n>(?)	<DNPd>
:ENABle (?)	<CPD> { ON OFF }
:CURRent<n>(?)	<DNPd>
:ENABle (?)	<CPD> { ON OFF }
:PHAR	
:POWer?	<DNPd>, <DNPd>
:VOLTage<n>(?)	<DNPd>
:PHASe(?)	<DNPd>
:ENABle (?)	<CPD> { ON OFF }
:HARMonic<y>(?)	<DNPd>
:PHASe(?)	<DNPd>
:MODulation(?)	<DNPd>
:SHAPE(?)	<CPD> { SIN RECT OFF }
:DUTY(?)	<DNPd>
:CURRent<n>(?)	<DNPd>
:PHASe(?)	<DNPd>
:ENABle(?)	<CPD> { ON OFF }
:HARMonic<y>(?)	<DNPd>
:PHASe(?)	<DNPd>
:MODulation(?)	<DNPd>
:SHAPE(?)	<CPD> { SIN RECT OFF }
:DUTY(?)	<DNPd>

:FREQuency(?)	<DNPd >
:MODulation(?)	<DNPd >
:PIH	
:VOLTage<n>(?)	<DNPd>
:PHASe(?)	<DNPd>
:ENABle(?)	<CPD> { ON OFF }
:IHARmonic(?)	<DNPd>
:CURRent<n>(?)	<DNPd>
:PHASe(?)	<DNPd>
:ENABle(?)	<CPD> { ON OFF }
:IHARmonic(?)	<DNPd>
:FREQuency(?)	<DNPd >
:IHARmonic(?)	<DNPd >
:PDIP	
:VOLTage<n>(?)	<DNPd>
:PHASe(?)	<DNPd>
:ENABle(?)	<CPD> { ON OFF }
:CHANge (?)	<DNPd>
:CURRent<n>(?)	<DNPd>
:PHASe(?)	<DNPd>
:ENABle(?)	<CPD> { ON OFF }
:CHANge (?)	<DNPd>
:FREQuency(?)	<DNPd >
:TIME(?)	<DNPd >,<DNPd >,<DNPd >,<DNPd >,<DNPd >
:TRIGger	
:INPut(?)	<CPD> { OFF IN3 }
:SYNChronization(?)	<CPD> { OFF ON }
:REPetition (?)	<CPD> { ONE REPeat }
:STARt	
:EAC	
:ENERgy?	
:DEViation?	
:POWER?	
[:POWER]	
:UNIT(?)	<CPD> { W VA VAR }
:VOLTage(?)	<DNPd>
:CURRent(?)	<DNPd>
[:CURRent]	
:PHASe(?)	<DNPd>
:POLarity(?)	<CPD> { LEAD LAG }
:FREQuency(?)	<DNPd >
:CONStant(?)	<DNPd>
:TIME(?)	<DNPd>
:CONTRol(?)	<CPD> { PACK CNT1 CNT2 TIM1 TIM2 FR1 FR2 FR3 }
:TEST	
:TIME(?)	<DNPd>
:COUNt(?)	<DNPd>
:FREQ?	<DNPd>

:WUP	
:TIME(?)	<DNPD>
:COUNT(?)	<DNPD>
:EDC	
:ENERgy?	
:DEVIation?	
:POWer?	
:VOLTage(?)	<DNPD>
:CURRent(?)	<DNPD>
:CONStant(?)	<DNPD>
:TIME(?)	<DNPD>
:CONTRol(?)	<CPD> { PACK CNT1 CNT2 TIM1 TIM2 FR1 FR2 FR3 }
:TEST	
:TIME(?)	<DNPD>
:COUNT(?)	<DNPD>
:FREQ?	<DNPD>
:WUP	
:TIME(?)	<DNPD>
:COUNT(?)	<DNPD>
:EACI	
:ENERgy?	
:DEVIation?	
:POWer?	
:VOLTage(?)	<DNPD>
:CURRent(?)	<DNPD>
[:CURRent]	
:PHASe(?)	<DNPD>
:FREQuency(?)	<DNPD>
:CONStant(?)	<DNPD>
:TIME(?)	<DNPD>
:CONTRol(?)	<CPD> { PACK CNT1 CNT2 TIM1 TIM2 FR1 FR2 FR3 }
:TEST	
:TIME(?)	<DNPD>
:COUNT(?)	<DNPD>
:FREQ?	<DNPD>
:WUP	
:TIME(?)	<DNPD>
:COUNT(?)	<DNPD>
:EDCI	
:ENERgy?	
:DEVIation?	
:POWer?	
:VOLTage(?)	<DNPD>
:CURRent(?)	<DNPD>
:CONStant(?)	<DNPD>
:TIME(?)	<DNPD>
:CONTRol(?)	<CPD> { PACK CNT1 CNT2 TIM1 TIM2

	FR1 FR2 FR3 }
:TEST	
:TIME(?)	<DNPD>
:COUNt(?)	<DNPD>
:FREQ?	<DNPD>
:WUP	
:TIME(?)	<DNPD>
:COUNt(?)	<DNPD>
:VAC	
:VOLTage(?)	<DNPD>
:FREQuency(?)	<DNPD >
:VDC	
:VOLTage(?)	<DNPD>
:CAC	
:CURREnt(?)	<DNPD>
:FREQuency(?)	<DNPD >
:CDC	
:CURREnt(?)	<DNPD>
:CACI	
:CURREnt(?)	<DNPD>
:FREQuency(?)	<DNPD >
:CDCI	
:CURREnt(?)	<DNPD>

[SOUR]:MODE?

This command returns selected mode of the calibrator { PAC | PDC | PACI | PDCI | PACE | PDCE | PHAR | PIH | PDIP | EAC | EDC | EACI | EDCI | VAC | VDC | CAC | CDC | CACI | CDCI }.

- PAC – Power AC mode
- PDC – Power DC mode
- PACI – Power AC high current mode
- PDCI – Power DC high current mode
- PACE – Power AC extended mode
- PDCE – Power DC extended mode
- PHAR – Power harmonic mode
- PIH – Power interharmonic mode
- PDIP – Power Dip/Swell mode
- EAC – Energy AC mode
- EDC – Energy DC mode
- EACI – Energy AC high current mode
- EDCI – Energy DC high current mode
- VAC – Voltage AC mode
- VDC – Voltage DC mode
- CAC – Current AC mode
- CDC – Current DC mode
- CACI – Current AC high current mode
- CDCI – Current DC high current mode

Example:

MODE?

[SOUR]:PAC:POW(?) <DNPD>

This command sets the power value in Power AC mode.

<DNPD>

Parameter represents the value of the power expressed in actual units (W, VA, VAR).

If query is sent, calibrator returns the set value of power using standard exponential format.

Example: 100.60 W is returned as 1.006000e+002.

Example:

AC power 1000W:

PAC:POW 1000

Note:

Command switches the calibrator in Power AC mode.

[SOUR]:PAC[:POW]:UNIT(?) <CPD> { W | VA | VAR }

This command selects units for power in the Power AC mode.

If query is sent, calibrator returns actual units in Power AC mode.

Example:

Select unit W for Power AC mode:

PAC:UNIT W

Note:

Command switches the calibrator in Power AC mode.

[SOUR]:PAC:VOLT(?) <DNPD>

This command sets the output voltage value.

<DNPD>

Parameter represents the value of the output voltage expressed in V.

If query is sent, calibrator returns the value of output voltage using standard exponential format.

Example: 110.12 V is returned as 1.101200e+002.

Example:

Voltage 230.5V:

PAC:VOLT 230.5

Note:

Command switches the calibrator in Power AC mode.

[SOUR]:PAC:CURR(?) <DNPD>

This command sets the output current value in Power AC mode.

<DNPD>

Parameter represents the value of the output current expressed in A.

If query is sent, calibrator returns the value of output current using standard exponential format.

Example: 11.012 A is returned as 1.101200e+001.

Example:

Current 23.05A:

PAC:CURR 23.05

Note:

Command switches the calibrator in Power AC mode.

[SOUR]:PAC[:CURR]:PHAS(?) <DNPD>

This command sets the phase angle between voltage and current.

<DNPD>

Represents the phase angle between the output voltage and current in degrees (PHAS:UNIT=DEG), or specified as a value of the power factor (PHAS:UNIT=COS).

If query is sent, calibrator returns the set value of the phase shift between the output voltage and current using standard exponential format. Example: 156.3° is returned as 1.563000e+002.

Example: PAC:PHAS 250.2 - sets 250.2° phase shift between the output voltage and current

(PHAS:UNIT=DEG) PAC:PHAS? - the calibrator returns 2.502000e+002

Example: PAC:PHAS 0.554 – sets power factor 0.554

(PHAS:UNIT=COS) PAC:PHAS? - the calibrator returns 5.540000e-001,LAG

Note:

Command switches the calibrator in Power AC mode.

[SOUR]:PAC[:CURR]:POLarity(?) <CPD> { LEAD | LAG }

This command sets the polarity of phase angle between voltage and current. Command is valid only for PHAS:UNIT=DEG.

<CPD>

Represents the polarity of phase angle between the output voltage and current.

If query is sent, calibrator returns the polarity of the phase angle between the output voltage and current.

Example:

PAC:POL LEAD sets the phase angle polarity to Lead

Note:

Command switches the calibrator in Power AC mode.

[SOUR]:PAC:FREQ(?) <DNPD>

This command sets the frequency in Power AC mode.

<DNPD>

Parameter represents the value of frequency expressed in Hz.

If query is sent, calibrator returns the value of frequency using standard exponential format.

Example: 50Hz is returned as 5.000000e+001.

Example:

Frequency 60Hz:

PAC:FREQ 60

Notes:

Command switches the calibrator in Power AC mode.

[SOUR]:PDC:POW(?) <DNPD>

This command sets the power value in Power DC mode.

<DNPD>

Parameter represents the value of the power expressed in W.

If query is sent, calibrator returns the set value of power using standard exponential format.
Example: 100.60 W is returned as 1.006000e+002.

Example:

DC power 1000W:

PDC:POW 1000

Note:

Command switches the calibrator in Power DC mode.

[SOUR]:PDC:VOLT(?) <DNPD>

This command sets the output voltage value in Power DC mode.

<DNPD>

Parameter represents the value of the output voltage expressed in V.

If query is sent, calibrator returns the value of output voltage using standard exponential format.
Example: 110.12 V is returned as 1.101200e+002.

Example:

Voltage 230.5V:

PDC:VOLT 230.5

Note:

Command switches the calibrator in Power DC mode.

[SOUR]:PDC:CURR(?) <DNPD>

This command sets the output current value in Power DC mode.

<DNPD>

Parameter represents the value of the output current expressed in A.

If query is sent, calibrator returns the value of output current using standard exponential format.
Example: 11.012 A is returned as 1.101200e+001.

Example:

Current 23.05A:

PDC:CURR 23.05

Note:

Command switches the calibrator in Power DC mode.

[SOUR]:PACI:POW(?) <DNPD>

This command sets the power value in Power AC high current mode.

<DNPD>

Parameter represents the value of the power expressed in actual units (W, VA, VAr).

If query is sent, calibrator returns the set value of power using standard exponential format.
Example: 100.60 W is returned as 1.006000e+002.

Example:

AC power 1000W:
PACI:POW 1000

Note:

Command switches the calibrator in Power AC high current mode.

[SOUR]:PACI[:POW]:UNIT(?) <CPD> { W | VA | VAR }

This command selects units for power in the Power AC high current mode.

If query is sent, calibrator returns actual units in Power AC high current mode.

Example:

Select unit W for Power AC high current mode:
PACI:UNIT W

Note:

Command switches the calibrator in Power AC high current mode.

[SOUR]:PACI:VOLT(?) <DNPD>

This command sets the output voltage value.

<DNPD>

Parameter represents the value of the output voltage expressed in V.

If query is sent, calibrator returns the value of output voltage using standard exponential format.

Example: 110.12 V is returned as 1.101200e+002.

Example:

Voltage 230.5V:
PAC:VOLT 230.5

Note:

Command switches the calibrator in Power AC high current mode.

[SOUR]:PACI:CURR(?) <DNPD>

This command sets the output current value in Power AC high current mode.

<DNPD>

Parameter represents the value of the output current expressed in A.

If query is sent, calibrator returns the value of output current using standard exponential format.

Example: 11.012 A is returned as 1.101200e+001.

Example:

Current 23.05A:
PACI:CURR 23.05

Note:

Command switches the calibrator in Power AC high current mode.

[SOUR]:PACI[:CURR]:PHAS(?) <DNPD>

This command sets the phase angle between voltage and current.

<DNPD>

Represents the phase angle between the output voltage and current in degrees (PHAS:UNIT=DEG), or specified as a value of the power factor (PHAS:UNIT=COS).

If query is sent, calibrator returns the set value of the phase shift between the output voltage and current using standard exponential format. Example: 156.3 ° is returned as 1.563000e+002.

Example: PACI:PHAS 250.2 - sets 250.2° phase shift between the output voltage and current

(PHAS:UNIT=DEG) PACI:PHAS? - the calibrator returns 2.502000e+002

Example: PACI:PHAS 0.554 – sets power factor 0.554

(PHAS:UNIT=COS) PACI:PHAS? - the calibrator returns 5.540000e-001,LAG

Note:

Command switches the calibrator in Power AC high current mode.

[SOUR]:PACI[:CURR]:POLarity(?) <CPD> { LEAD | LAG }

This command sets the polarity of phase angle between voltage and current. Command is valid only for PHAS:UNIT=DEG.

<CPD>

Represents the polarity of phase angle between the output voltage and current.

If query is sent, calibrator returns the polarity of the phase angle between the output voltage and current.

Example:

PACI:POL LEAD sets the phase angle polarity to Lead

Note:

Command switches the calibrator in Power AC high current mode.

[SOUR]:PACI:FREQ(?) <DNPD>

This command sets the frequency in Power AC high current mode.

<DNPD>

Parameter represents the value of frequency expressed in Hz.

If query is sent, calibrator returns the value of frequency using standard exponential format. Example: 50Hz is returned as 5.000000e+001.

Example:

Frequency 60Hz:

PACI:FREQ 60

Notes:

Command switches the calibrator in Power AC high current mode.

[SOUR]:PDCI:POW(?) <DNPD>

This command sets the power value in Power DC high current mode.

<DNPD>

Parameter represents the value of the power expressed in W.

If query is sent, calibrator returns the set value of power using standard exponential format.
Example: 100.60 W is returned as 1.006000e+002.

Example:

DC power 1000W:

PDCI:POW 1000

Note:

Command switches the calibrator in Power DC high current mode.

[SOUR]:PDCI:VOLT(?) <DNPD>

This command sets the output voltage value in Power DC high current mode.

<DNPD>

Parameter represents the value of the output voltage expressed in V.

If query is sent, calibrator returns the value of output voltage using standard exponential format.
Example: 110.12 V is returned as 1.101200e+002.

Example:

Voltage 230.5V:

PDCI:VOLT 230.5

Note:

Command switches the calibrator in Power DC high current mode.

[SOUR]:PDCI:CURR(?) <DNPD>

This command sets the output current value in Power DC high current mode.

<DNPD>

Parameter represents the value of the output current expressed in A.

If query is sent, calibrator returns the value of output current using standard exponential format.
Example: 11.012 A is returned as 1.101200e+001.

Example:

Current 23.05A:

PDCI:CURR 23.05

Note:

Command switches the calibrator in Power DC high current mode.

[SOUR]:PACE:POW?

This query returns the set value of power using standard exponential format. Example: 100.60 W is returned as 1.006000e+002.

Note:

Query switches the calibrator in Power AC extended mode.

[SOUR]:PACE[:POW]:UNIT(?) <CPD> { W | VA | VAR }

This command selects units for power in the Power AC extended mode.

If query is sent, calibrator returns actual units in Power AC extended mode.

Example:

Select unit W for Power AC extended mode:

PACE:UNIT W

Note:

Command switches the calibrator in Power AC extended mode.

[SOUR]:PACE:VOLT<n>(?) <DNPD>

This command sets the output voltage value in channel <n>

<DNPD>

Parameter represents the value of the output voltage expressed in V.

<n>

Parameter represents the output channel (1, 2 or 3).

If query is sent, calibrator returns the value of output voltage using standard exponential format.

Example: 110.12 V is returned as 1.101200e+002.

Example:

Voltage 230.5V in channel 1:

PACE:VOLT1 230.5

Note:

Command switches the calibrator in Power AC extended mode.

[SOUR]:PACE:VOLT<n>:PHAS(?) <DNPD>

This command sets the phase angle between voltage output in channel <n> and internal reference phase.

<DNPD>

Represents the phase angle in degrees.

If query is sent, calibrator returns the set value of the phase angle using standard exponential format. Example: 156.3 ° is returned as 1.563000e+002.

Example:

```
PACE:VOLT1:PHAS 0
PACE:VOLT2:PHAS 120
PACE:VOLT3:PHAS 240
```

Note:

Command switches the calibrator in Power AC extended mode.

[SOUR]:PACE:VOLT<n>:ENAB(?) <CPD> { ON | OFF }

This command enables (disables) the voltage output in channel <n>. Disabled outputs are OFF also during OUTP ON.

- ON - enables the output
- OFF - disables the output

If query is sent, calibrator returns ON if the output is enabled or OFF if it is disabled.

Example:

```
PACE:VOLT1:ENAB ON
```

Note:

Command switches the calibrator in Power AC extended mode.

[SOUR]:PACE:CURR<n>(?) <DNPD>

This command sets the output current value in channel <n>

<DNPD>

Parameter represents the value of the output current expressed in A.

<n>

Parameter represents the output channel (1, 2 or 3).

If query is sent, calibrator returns the value of output current using standard exponential format.

Example: 11.012 V is returned as 1.101200e+001.

Example:

Current 23.05A in channel 1:

```
PACE:CURR1 23.05
```

Note:

Command switches the calibrator in Power AC extended mode.

[SOUR]:PACE:CURR<n>:PHAS(?) <DNPD>

This command sets the phase angle between current output in channel <n> and internal reference phase.

<DNPD>

Represents the phase angle in degrees.

If query is sent, calibrator returns the set value of the phase angle using standard exponential format. Example: 156.3 ° is returned as 1.563000e+002.

Example:

```
PACE:CURR1:PHAS 0
PACE: CURR 2:PHAS 120
PACE: CURR 3:PHAS 240
```

Note:

Command switches the calibrator in Power AC extended mode.

[SOUR]:PACE:CURR<n>:ENAB(?) <CPD> { ON | OFF }

This command enables (disables) the current output in channel <n>. Disabled outputs are OFF also during OUTP ON.

- ON - enables the output
- OFF - disables the output

If query is sent, calibrator returns ON if the output is enabled or OFF if it is disabled.

Example:

```
PACE:CURR1:ENAB ON
```

Note:

Command switches the calibrator in Power AC extended mode.

[SOUR]:PACE:FREQ(?) <DNPD>

This command sets the frequency in Power AC extended mode.

<DNPD>

Parameter represents the value of frequency expressed in Hz.

If query is sent, calibrator returns the value of frequency using standard exponential format.

Example: 50Hz is returned as 5.000000e+001.

Example:

```
Frequency 60Hz:
    PACE:FREQ 60
```

Notes:

Command switches the calibrator in Power AC extended mode.

[SOUR]:PDCE:POW?

This command sets the power value in Power DC extended mode.

This query returns the set value of power using standard exponential format. Example: 100.60 W is returned as 1.006000e+002.

Note:

Query switches the calibrator in Power DC extended mode.

[SOUR]:PDCE:VOLT<n>(?) <DNPD>

This command sets the output voltage value in channel <n>

<DNPD>

Parameter represents the value of the output voltage expressed in V.

<n>

Parameter represents the output channel (1, 2 or 3).

If query is sent, calibrator returns the value of output voltage using standard exponential format.
Example: 110.12 V is returned as 1.101200e+002.

Example:

Voltage 230.5V in channel 1:
PDCE:VOLT1 230.5

Note:

Command switches the calibrator in Power DC extended mode.

[SOUR]:PDCE:VOLT<n>:ENAB(?) <CPD> { ON | OFF }

This command enables (disables) the voltage output in channel <n>. Disabled outputs are OFF also during OUTP ON.

- ON - enables the output
- OFF - disables the output

If query is sent, calibrator returns ON if the output is enabled or OFF if it is disabled.

Example:

PDCE:VOLT1:ENAB ON

Note:

Command switches the calibrator in Power DC extended mode.

[SOUR]:PDCE:CURR<n>(?) <DNPD>

This command sets the output current value in channel <n>

<DNPD>

Parameter represents the value of the output current expressed in A.

<n>

Parameter represents the output channel (1, 2 or 3).

If query is sent, calibrator returns the value of output current using standard exponential format.
Example: 11.012 V is returned as 1.101200e+001.

Example:

Current 23.05A in channel 1:
PDCE:CURR1 23.05

Note:

Command switches the calibrator in Power DC extended mode.

[SOUR]:PDCE:CURR<n>:ENAB(?) <CPD> { ON | OFF }

This command enables (disables) the current output in channel <n>. Disabled outputs are OFF also during OUTP ON.

- ON - enables the output
- OFF - disables the output

If query is sent, calibrator returns ON if the output is enabled or OFF if it is disabled.

Example:

PDCE:CURR1:ENAB ON

Note:

Command switches the calibrator in Power DC extended mode.

[SOUR]:PHAR:POW?

This query returns active and reactive power values using standard exponential format.

Example: 100.60 W, 1.1 VAR is returned as 1.006000e+002, 1.100000e+000.

Note:

Query switches the calibrator in Power Harmonic mode.

[SOUR]:PHAR:VOLT<n>(?) <DNPD>

This command sets the output voltage value in channel <n>

<DNPD>

Parameter represents the value of the output voltage expressed in V.

<n>

Parameter represents the output channel (1, 2 or 3).

If query is sent, calibrator returns the value of output voltage using standard exponential format.

Example: 110.12 V is returned as 1.101200e+002.

Example:

Voltage 230.5V in channel 1:

PHAR:VOLT1 230.5

Note:

Command switches the calibrator in Power Harmonic mode.

[SOUR]:PHAR:VOLT<n>:PHAS(?) <DNPD>

This command sets the phase angle between voltage output in channel <n> and internal reference phase.

<DNPD>

Represents the phase angle in degrees.

If query is sent, calibrator returns the set value of the phase angle using standard exponential format. Example: 156.3 ° is returned as 1.563000e+002.

Example:

PHAR:VOLT1:PHAS 0

PHAR:VOLT2:PHAS 120

PHAR:VOLT3:PHAS 240

Note:

Command switches the calibrator in Power Harmonic mode.

[SOUR]:PHAR:VOLT<n>:ENAB(?) <CPD> { ON | OFF }

This command enables (disables) the voltage output in channel <n>. Disabled outputs are OFF also during OUTP ON.

- ON - enables the output
- OFF - disables the output

If query is sent, calibrator returns ON if the output is enabled or OFF if it is disabled.

Example:

PHAR:VOLT1:ENAB ON

Note:

Command switches the calibrator in Power Harmonic mode.

[SOUR]:PHAR:VOLT<n>:HARM<y> (?) <DNPD>

This command sets the level of <y> harmonic in output voltage in channel <n>

<DNPD>

Parameter represents the level of <y> harmonic expressed in %.

<n>

Parameter represents the output channel (1, 2 or 3).

<y>

Parameter represents the harmonic order (1 to 50). Number 1 is for query only.

If query is sent, calibrator returns the level of the harmonic order using standard exponential format. Example: 10% is returned as 1.000000e+001.

Example:

Set harmonic order 2 to 5.3% in voltage channel 1:

PHAR:VOLT1:HARM2 5.3

Note:

Command switches the calibrator in Power Harmonic mode.

[SOUR]:PHAR:VOLT<n>:HARM<y>:PHAS(?) <DNPD>

This command sets the phase shift of <y> harmonic component in channel <n>

<DNPD>

Parameter represents the phase shift of <y> harmonic component expressed in °.

<n>

Parameter represents the output channel (1, 2 or 3).

<y>

Parameter represents the harmonic order (2 to 50). Order 1 has zero phase shift and can't be changed.

If query is sent, calibrator returns the phase shift of harmonic component using standard exponential format. Example: 10° is returned as 1.000000e+001.

Example:

Set phase shift of harmonic component 2 to 5.3° in voltage channel 1:

```
PHAR:VOLT1:HARM2:PHAS 5.3
```

Note:

Command switches the calibrator in Power Harmonic mode.

[SOUR]:PHAR:VOLT<n>:MOD(?) <DNPD>

This command sets the modulation level for voltage output in channel <n>.

<DNPD>

Represents the modulation level in %.

If query is sent, calibrator returns the modulation level using standard exponential format.

Example: 12.45° is returned as 1.145000e+001.

Example:

```
PHAR:VOLT1:MOD 12.45
```

Note:

Command switches the calibrator in Power Harmonic mode.

[SOUR]:PHAR:VOLT<n>:MOD:SHAP(?) <CPD> { SIN | RECT | OFF }

This command sets type of modulation for voltage output in channel <n>.

<CPD>

- SIN – modulation using sinusoidal wave shape
- RECT – modulation using rectangular wave shape
- OFF - disables modulation

If query is sent, calibrator returns SIN, RECT or OFF.

Example:

```
PHAR:VOLT1:MOD:SHAP SIN
```

Note:

Command switches the calibrator in Power Harmonic mode.

[SOUR]:PHAR:VOLT<n>:MOD:DUTY(?) <DNPD>

This command sets the duty cycle of rectangular modulation for voltage output in channel <n>.

<DNPD>

Represents the duty cycle in %.

If query is sent, calibrator returns the duty cycle using standard exponential format. Example: 50% is returned as 5.000000e+001.

Example:

PHAR:VOLT1:MOD:DUTY 50

Note:

Command switches the calibrator in Power Harmonic mode.

[SOUR]:PHAR:CURR<n>(?) <DNPD>

This command sets the output current value in channel <n>

<DNPD>

Parameter represents the value of the output current expressed in A.

<n>

Parameter represents the output channel (1, 2 or 3).

If query is sent, calibrator returns the value of output current using standard exponential format. Example: 11.012 A is returned as 1.101200e+001.

Example:

Voltage 23.05A in channel 1:

PHAR:CURR1 23.05

Note:

Command switches the calibrator in Power Harmonic mode.

[SOUR]:PHAR:CURR<n>:PHAS(?) <DNPD>

This command sets the phase angle between current output in channel <n> and internal reference phase.

<DNPD>

Represents the phase angle in degrees.

If query is sent, calibrator returns the set value of the phase angle using standard exponential format. Example: 156.3 ° is returned as 1.563000e+002.

Example:

PHAR:CURR1:PHAS 0

PHAR:CURR2:PHAS 120

PHAR:CURR3:PHAS 240

Note:

Command switches the calibrator in Power Harmonic mode.

[SOUR]:PHAR:CURR<n>:ENAB(?) <CPD> { ON | OFF }

This command enables (disables) the current output in channel <n>. Disabled outputs are OFF also during OUTP ON.

- ON - enables the output
- OFF - disables the output

If query is sent, calibrator returns ON if the output is enabled or OFF if it is disabled.

Example:

PHAR:CURR1:ENAB ON

Note:

Command switches the calibrator in Power Harmonic mode.

[SOUR]:PHAR:CURR<n>:HARM<y>(?) <DNPD>

This command sets the level of <y> harmonic in output current in channel <n>

<DNPD>

Parameter represents the level of <y> harmonic expressed in %.

<n>

Parameter represents the output channel (1, 2 or 3).

<y>

Parameter represents the harmonic order (1 to 50). Number 1 is for query only.

If query is sent, calibrator returns the level of the harmonic order using standard exponential format. Example: 10% is returned as 1.000000e+001.

Example:

Set harmonic order 2 to 5.3% in voltage channel 1:

PHAR:CURR1:HARM2 5.3

Note:

Command switches the calibrator in Power Harmonic mode.

[SOUR]:PHAR:CURR<n>:HARM<y>:PHAS(?) <DNPD>

This command sets the phase shift of <y> harmonic component in channel <n>

<DNPD>

Parameter represents the phase shift of <y> harmonic component expressed in °.

<n>

Parameter represents the output channel (1, 2 or 3).

<y>

Parameter represents the harmonic order (2 to 50). Order 1 has zero phase shift and can't be changed.

If query is sent, calibrator returns the phase shift of harmonic component using standard exponential format. Example: 10° is returned as 1.000000e+001.

Example:

Set phase shift of harmonic component 2 to 5.3° in current channel 1:

PHAR:CURR1:HARM2:PHAS 5.3

Note:

Command switches the calibrator in Power Harmonic mode.

[SOUR]:PHAR:CURR<n>:MOD(?) <DNPD>

This command sets the modulation level for current output in channel <n>.

<DNPD>

Parameter represents the modulation level in %.

If query is sent, calibrator returns the modulation level using standard exponential format. Example: 12.45° is returned as 1.145000e+001.

Example:

PHAR:CURR1:MOD 12.45

Note:

Command switches the calibrator in Power Harmonic mode.

[SOUR]:PHAR:CURR<n>:MOD:SHAP(?) <CPD> { SIN | RECT | OFF }

This command sets type of modulation for current output in channel <n>.

<CPD>

- SIN – modulation using sinusoidal wave shape
- RECT – modulation using rectangular wave shape
- OFF - disables modulation

If query is sent, calibrator returns SIN, RECT or OFF.

Example:

PHAR:CURR1:MOD:SHAP SIN

Note:

Command switches the calibrator in Power Harmonic mode.

[SOUR]:PHAR:CURR<n>:MOD:DUTY(?) <DNPD>

This command sets the duty cycle of rectangular modulation for current output in channel <n>.

<DNPD>

Represents the duty cycle in %.

If query is sent, calibrator returns the duty cycle using standard exponential format. Example: 50% is returned as 5.000000e+001.

Example:

PHAR:CURR1:MOD:DUTY 50

Note:

Command switches the calibrator in Power Harmonic mode.

[SOUR]:PHAR:FREQ(?) <DNPD>

This command sets the frequency in Power Harmonic mode.

<DNPD>

Parameter represents the value of frequency expressed in Hz.

If query is sent, calibrator returns the value of frequency using standard exponential format. Example: 50Hz is returned as 5.000000e+001.

Example:

Frequency 60Hz:

PHAR:FREQ 60

Notes:

Command switches the calibrator in Power Harmonic mode.

[SOUR]:PHAR:FREQ:MOD(?) <DNPD>

This command sets the modulation frequency in Power Harmonic mode.

<DNPD>

Parameter represents the value of modulation frequency expressed in Hz.

If query is sent, calibrator returns the value of modulation frequency using standard exponential format. Example: 5Hz is returned as 5.000000e+000.

Example:

Modulation frequency 5.3Hz:

PHAR:FREQ:MOD 5.3

Notes:

Command switches the calibrator in Power Harmonic mode.

[SOUR]:PIH

This command switches the calibrator in Power Interharmonic mode.

Example:

PIH

[SOUR]:PIH:VOLT<n>(?) <DNPD>

This command sets the output voltage value in channel <n>

<DNPD>

Parameter represents the value of the output voltage expressed in V.

<n>

Parameter represents the output channel (1, 2 or 3).

If query is sent, calibrator returns the value of output voltage using standard exponential format. Example: 110.12 V is returned as 1.101200e+002.

Example:

Voltage 230.5V in channel 1:

PIH:VOLT1 230.5

Note:

Command switches the calibrator in Power Interharmonic mode.

[SOUR]:PIH:VOLT<n>:PHAS(?) <DNPD>

This command sets the phase angle between voltage output in channel <n> and internal reference phase.

<DNPD>

Represents the phase angle in degrees.

If query is sent, calibrator returns the set value of the phase angle using standard exponential format. Example: 156.3 ° is returned as 1.563000e+002.

Example:

PIH:VOLT1:PHAS 0

PIH:VOLT2:PHAS 120

PIH:VOLT3:PHAS 240

Note:

Command switches the calibrator in Power Interharmonic mode.

[SOUR]:PIH:VOLT<n>:ENAB(?) <CPD> { ON | OFF }

This command enables (disables) the voltage output in channel <n>. Disabled outputs are OFF also during OUTP ON.

- ON - enables the output
- OFF - disables the output

If query is sent, calibrator returns ON if the output is enabled or OFF if it is disabled.

Example:

PIH:VOLT1:ENAB ON

Note:

Command switches the calibrator in Power Interharmonic mode.

[SOUR]:PIH:VOLT<n>:IHAR(?) <DNPD>

This command sets the level of interharmonic component for voltage output in channel <n>.

<DNPD>

Represents the voltage in V.

If query is sent, calibrator returns the value of output voltage using standard exponential format. Example: 110.12 V is returned as 1.101200e+002.

Example:

Interharmonic component 23.05V in channel 1:

PIH:VOLT1:IHAR 23.05

Note:

Command switches the calibrator in Power Interharmonic mode.

[SOUR]:PIH:CURR<n>(?) <DNPD>

This command sets the output current value in channel <n>

<DNPD>

Parameter represents the value of the output current expressed in A.

<n>

Parameter represents the output channel (1, 2 or 3).

If query is sent, calibrator returns the value of output voltage using standard exponential format. Example: 11.012 V is returned as 1.101200e+001.

Example:

Voltage 23.05V in channel 1:

PIH:CURR1 23.05

Note:

Command switches the calibrator in Power Interharmonic mode.

[SOUR]:PIH:CURR<n>:PHAS(?) <DNPD>

This command sets the phase angle between current output in channel <n> and internal reference phase.

<DNPD>

Represents the phase angle in degrees.

If query is sent, calibrator returns the set value of the phase angle using standard exponential format. Example: 156.3 ° is returned as 1.563000e+002.

Example:

PIH:CURR1:PHAS 0

PIH:CURR1:PHAS 120

PIH:CURR1:PHAS 240

Note:

Command switches the calibrator in Power Interharmonic mode.

[SOUR]:PIH:CURR<n>:ENAB(?) <CPD> { ON | OFF }

This command enables (disables) the current output in channel <n>. Disabled outputs are OFF also during OUTP ON.

- ON - enables the output
- OFF - disables the output

If query is sent, calibrator returns ON if the output is enabled or OFF if it is disabled.

Example:

```
PIH:CURR1:ENAB ON
```

Note:

Command switches the calibrator in Power Interharmonic mode.

[SOUR]:PIH:CURR<n>:IHAR(?) <DNPD>

This command sets the level of interharmonic component for current output in channel <n>.

<DNPD>

Represents the current in A.

If query is sent, calibrator returns the value of output voltage using standard exponential format.

Example: 11.012 V is returned as 1.101200e+001.

Example:

Interharmonic component 2.305A in channel 1:

```
PIH:CURR1:IHAR 2.305
```

Note:

Command switches the calibrator in Power Interharmonic mode.

[SOUR]:PIH:FREQ(?) <DNPD>

This command sets the frequency in Power Interharmonic mode.

<DNPD>

Parameter represents the value of frequency expressed in Hz.

If query is sent, calibrator returns the value of frequency using standard exponential format.

Example: 50Hz is returned as 5.000000e+001.

Example:

Frequency 60Hz:

```
PIH:FREQ 60
```

Notes:

Command switches the calibrator in Power Interharmonic mode.

[SOUR]:PIH:FREQ:IHAR(?) <DNPD>

This command sets the modulation frequency in Power Interharmonic mode.

<DNPD>

Parameter represents the value of modulation frequency expressed in Hz.

If query is sent, calibrator returns the value of modulation frequency using standard exponential format. Example: 5Hz is returned as 5.000000e+000.

Example:

Interharmonic frequency 72.5Hz:

PIH:FREQ:IHAR 72.5

Notes:

Command switches the calibrator in Power Interharmonic mode.

[SOUR]:PDIP

This command switches the calibrator in Power Dip/Swell mode.

Example:

PDIP

[SOUR]:PDIP:VOLT<n>(?) <DNPD>

This command sets the output voltage value in channel <n>

<DNPD>

Parameter represents the value of the output voltage expressed in V.

<n>

Parameter represents the output channel (1, 2 or 3).

If query is sent, calibrator returns the value of output voltage using standard exponential format.

Example: 110.12 V is returned as 1.101200e+002.

Example:

Voltage 230.5V in channel 1:

PDIP:VOLT1 230.5

Note:

Command switches the calibrator in Power Dip/Swell mode.

[SOUR]:PDIP:VOLT<n>:PHAS(?) <DNPD>

This command sets the phase angle between voltage output in channel <n> and internal reference phase.

<DNPD>

Represents the phase angle in degrees.

If query is sent, calibrator returns the set value of the phase angle using standard exponential format. Example: 156.3 ° is returned as 1.563000e+002.

Example:

PDIP:VOLT1:PHAS 0

PDIP:VOLT2:PHAS 120

PDIP:VOLT3:PHAS 240

Note:

Command switches the calibrator in Power Dip/Swell mode.

[SOUR]:PDIP:VOLT<n>:ENAB(?) <CPD> { ON | OFF }

This command enables (disables) the voltage output in channel <n>. Disabled outputs are OFF also during OUTP ON.

- ON - enables the output
- OFF - disables the output

If query is sent, calibrator returns ON if the output is enabled or OFF if it is disabled.

Example:

PDIP:VOLT1:ENAB ON

Note:

Command switches the calibrator in Power Dip/Swell mode.

[SOUR]:PDIP:VOLT<n>:CHAN(?) <DNPD>

This command sets the level of change (Dip/Swell - t3 period) for voltage output in channel <n>.

<DNPD>

Represents the voltage in V.

If query is sent, calibrator returns the value of output voltage using standard exponential format. Example: 110.12 V is returned as 1.101200e+002.

Example:

Dip/Swell change 23.05V in channel 1:

PDIP:VOLT1:CHAN 23.05

Note:

Command switches the calibrator in Power Dip/Swell mode.

[SOUR]:PDIP:CURR<n>(?) <DNPD>

This command sets the output current value in channel <n>

<DNPD>

Parameter represents the value of the output current expressed in A.

<n>

Parameter represents the output channel (1, 2 or 3).

If query is sent, calibrator returns the value of output current using standard exponential format. Example: 11.012 A is returned as 1.101200e+001.

Example:

Current 23.05A in channel 1:
PDIP:CURR1 23.05

Note:

Command switches the calibrator in Power Dip/Swell mode.

[SOUR]:PDIP:CURR<n>:PHAS(?) <DNPD>

This command sets the phase angle between current output in channel <n> and internal reference phase.

<DNPD>

Represents the phase angle in degrees.

If query is sent, calibrator returns the set value of the phase angle using standard exponential format. Example: 156.3 ° is returned as 1.563000e+002.

Example:

PDIP:CURR1:PHAS 0
PDIP:CURR2:PHAS 120
PDIP:CURR3:PHAS 240

Note:

Command switches the calibrator in Power Dip/Swell mode.

[SOUR]:PDIP:CURR<n>:ENAB(?) <CPD> { ON | OFF }

This command enables (disables) the current output in channel <n>. Disabled outputs are OFF also during OUTP ON.

- ON - enables the output
- OFF - disables the output

If query is sent, calibrator returns ON if the output is enabled or OFF if it is disabled.

Example:

PDIP:CURR1:ENAB ON

Note:

Command switches the calibrator in Power Dip/Swell mode.

[SOUR]:PDIP:CURR<n>:CHAN(?) <DNPD>

This command sets the level of change (Dip/Swell - t3 period) for current output in channel <n>.

<DNPD>

Represents the current in A.

If query is sent, calibrator returns the value of output current using standard exponential format.
Example: 11.012 A is returned as 1.101200e+001.

Example:

Dip/Swell change 2.305A in channel 1:
PDIP:CURR1:CHAN 2.305

Note:

Command switches the calibrator in Power Dip/Swell mode.

[SOUR]:PDIP:FREQ(?) <DNPD>

This command sets the frequency in Power Dip/Swell mode.

<DNPD>

Parameter represents the value of frequency expressed in Hz.

If query is sent, calibrator returns the value of frequency using standard exponential format.
Example: 50Hz is returned as 5.000000e+001.

Example:

Frequency 60Hz:
PDIP:FREQ 60

Notes:

Command switches the calibrator in Power Dip/Swell mode.

[SOUR]:PDIP:TIME(?) <DNPD>,<DNPD>,<DNPD>,<DNPD>,<DNPD>

This command sets the time periods t1, t2, t3, t4 and t5 in Power Dip/Swell mode.

<DNPD>,<DNPD>,<DNPD>,<DNPD>,<DNPD>

Parameters represent the value of times (t1, t2, t3, t4 and t5) expressed in s.

If query is sent, calibrator returns time values using standard exponential format. Example: 50s is returned as 5.000000e+001.

Example:

period t1 100ms
period t2 20ms
period t3 30s
period t4 200ms
period t5 0s
PDIP:TIME 0.1, 0.02, 30, 0.2, 0

Notes:

Command switches the calibrator in Power Dip/Swell mode.

[SOUR]:PDIP:TRIG:INP(?) <CPD> { OFF | IN3 }

This command enables (disables) external trigger for Dip/Swell mode.

- OFF – disables external trigger for Dip/Swell function
- IN3 – enables external trigger for Dip/Swell function (TTL falling edge applied to input IN3)

If query is sent, calibrator returns IN3 if external trigger is enabled or OFF if it is disabled.

Example:

PDIP:TRIG:INP IN3

Note:

Command switches the calibrator in Power Dip/Swell mode.

[SOUR]:PDIP:TRIG:SYNC(?) <CPD> { OFF | ON }

This command enables (disables) synchronization of Dip/Swell shape.

- OFF – Dip/Swell shape starts immediately after trigger
- ON – start of Dip/Swell shape is synchronized with the phase 0°

If query is sent, calibrator returns ON if synchronization is enabled or OFF if it is disabled.

Example:

PDIP:TRIG:SYNC ON

Note:

Command switches the calibrator in Power Dip/Swell mode.

[SOUR]:PDIP:TRIG:REP(?) <CPD> { ONE | REP }

This sets automatic repetition of generated Dip/Swell shape.

- ONE – trigger starts generation of one Dip/Swell shape
- REP – trigger starts repeated generation of Dip/Swell shapes

If query is sent, calibrator returns ONE if repetition is disabled or REP if it is enabled.

Example:

PDIP:TRIG:REP ONE

Note:

Command switches the calibrator in Power Dip/Swell mode.

[SOUR]:PDIP:TRIG:STAR

This command starts generation of Dip/Swell shape.

Example:

PDIP:TRIG:STAR

Note:

Command switches the calibrator in Power Dip/Swell mode.

[SOUR]:EAC:ENER?

This query returns the set value of energy using standard exponential format. Example: 100.60 Ws is returned as 1.006000e+002.

Note:

Query switches the calibrator in Energy AC mode.

[SOUR]:EAC:DEV?

This query returns deviation between tested energy meter end the calibrator. Calculation of deviation is based on pulses generated by energy meter. Example: 0.612 % is returned as 6.120000e-001.

Note:

Query switches the calibrator in Energy AC mode.

[SOUR]:EAC:POW?

This query returns the set value of power using standard exponential format. Example: 100.60 W is returned as 1.006000e+002.

Note:

Query switches the calibrator in Energy AC mode.

[SOUR]:EAC[:POW]:UNIT(?) <CPD> { W | VA | VAR }

This command selects units for power in the Energy AC mode.

If query is sent, calibrator returns actual units in Energy AC mode.

Example:

Select unit W for Energy AC mode:

EAC:UNIT W

Note:

Command switches the calibrator in Energy AC mode.

[SOUR]:EAC:VOLT(?) <DNPD>

This command sets the output voltage value.

<DNPD>

Parameter represents the value of the output voltage expressed in V.

If query is sent, calibrator returns the value of output voltage using standard exponential format. Example: 110.12 V is returned as 1.101200e+002.

Example:

Voltage 230.5V:

EAC:VOLT 230.5

Note:

Command switches the calibrator in Energy AC mode.

[SOUR]:EAC:CURR(?) <DNPD>

This command sets the output current value in Energy AC mode.

<DNPD>

Parameter represents the value of the output current expressed in A.

If query is sent, calibrator returns the value of output current using standard exponential format.

Example: 11.012 A is returned as 1.101200e+001.

Example:

Current 23.05A:

EAC:CURR 23.05

Note:

Command switches the calibrator in Energy AC mode.

[SOUR]:EAC[:CURR]:PHAS(?) <DNPD>

This command sets the phase angle between voltage and current.

<DNPD>

Represents the phase angle between the output voltage and current in degrees (PHAS:UNIT=DEG), or specified as a value of the power factor (PHAS:UNIT=COS).

If query is sent, calibrator returns the set value of the phase shift between the output voltage and current using standard exponential format. Example: 156.3 ° is returned as 1.563000e+002.

Example: EAC:PHAS 250.2 - sets 250.2° phase shift between the output voltage and current

(PHAS:UNIT=DEG) EAC:PHAS? - the calibrator returns 2.502000e+002

Example: EAC:PHAS 0.554 – sets power factor 0.554

(PHAS:UNIT=COS) EAC:PHAS? - the calibrator returns 5.540000e-001,LAG

Note:

Command switches the calibrator in Energy AC mode.

[SOUR]:EAC[:CURR]:POLarity(?) <CPD> { LEAD | LAG }

This command sets the polarity of phase angle between voltage and current. Command is valid only for PHAS:UNIT=DEG.

<CPD>

Represents the polarity of phase angle between the output voltage and current.

If query is sent, calibrator returns the polarity of the phase angle between the output voltage and current.

Example:

EAC:POL LEAD sets the phase angle polarity to Lead

Note:

Command switches the calibrator in Energy AC mode.

[SOUR]:EAC:FREQ(?) <DNPD>

This command sets the frequency in Energy AC mode.

<DNPD>

Parameter represents the value of frequency expressed in Hz.

If query is sent, calibrator returns the value of frequency using standard exponential format.

Example: 50Hz is returned as 5.000000e+001.

Example:

Frequency 60Hz:

EAC:FREQ 60

Notes:

Command switches the calibrator in Energy AC mode.

[SOUR]:EAC:CONT(?) <CPD> { PACK | CNT1 | CNT2 | TIM1 | TIM2 | FR1 | FR2 | FR3 }

This command selects energy counting control mode.

<CPD>

represents the control mode of energy counting.

- PACK – Packet mode energy counting is controlled by time to deliver specific “Packet” of energy
- CNT1 – energy counting mode is controlled by pulses on input 1
- CNT2 – energy counting mode is controlled by pulses on input 2
- TIM1 – energy timer mode is controlled by pulses on input 1
- TIM2 – energy timer mode is controlled by pulses on input 2
- FR1 – frequency measuring on input 1
- FR2 – frequency measuring on input 2
- FR3 – frequency measuring on multimeter input V/COM

If query is sent, calibrator returns the selected control mode.

Example:

EAC:CONT PACK selects the Packet control mode which is controlled by time

Note:

Command switches the calibrator in Energy AC mode.

[SOUR]:EAC:TIME(?) <DNPD>

This command sets the time in Energy AC “Packet” control mode.

<DNPD>

Parameter represents the value of time expressed in s.

If query is sent, calibrator returns the value of time using standard exponential format. Example: 120s is returned as 1.200000e+002.

Example:

Time 60s:

EAC:TIME 60

Notes:

Command switches the calibrator in Energy AC mode.

[SOUR]:EAC:CONS(?) <DNPD>

This command sets number of pulses per selected unit (pulses generated by energy meter).

<DNPD>

Parameter represents the value number of pulses per selected unit.

If query is sent, calibrator returns set value using standard exponential format. Example: 400.0 i/kWh is returned as 4.000000e+002.

Example:

Number of pulses 1000 i/kVArh:

EAC:CONS 1000.0

EAC:UNIT VAR

Note:

Command switches the calibrator in Energy AC mode.

[SOUR]:EAC:TEST:TIME (?) <DNPD>

This command sets test timer in Energy AC mode.

<DNPD>

Parameter represents test time when pulses are counted.

If query is sent, calibrator returns the value of time using standard exponential format. Example: 20 is returned as 2.000000e+001.

Example:

EAC:TEST:TIME 10

Notes:

Command switches the calibrator in Energy AC mode.

[SOUR]:EAC:TEST:COUN(?) <DNPD>

This command sets test pulse counter in Energy AC mode.

<DNPD>

Parameter represents number of test pulses to be counted.

If query is sent, calibrator returns number of pulse counts using standard exponential format. Example: 20 is returned as 2.000000e+001.

Example:

```
EAC:TEST:COUN 10
```

Notes:

Command switches the calibrator in Energy AC mode.

[SOUR]:EAC:TEST:FREQ? <DNPD>

This query returns actual frequency generated by tested energy meter.

<DNPD>

Parameter represents measured frequency.

Calibrator returns frequency using standard exponential format. Example: 20 is returned as 2.000000e+001.

Example:

```
EAC:TEST:FREQ?
```

Notes:

Command switches the calibrator in Energy AC mode.

[SOUR]:EAC:WUP:TIME (?) <DNPD>

This command sets warm-up timer in Energy AC mode.

<DNPD>

Parameter represents warm-up time when pulses are counted.

If query is sent, calibrator returns the value of time using standard exponential format. Example: 20 is returned as 2.000000e+001.

Example:

```
EAC:WUP:TIME 10
```

Notes:

Command switches the calibrator in Energy AC mode.

[SOUR]:EAC:WUP:COUN(?) <DNPD>

This command sets warm-up pulse counter in Energy AC mode.

<DNPD>

Parameter represents number of warm-up pulses to be counted.

If query is sent, calibrator returns number of pulse counts using standard exponential format. Example: 20 is returned as 2.000000e+001.

Example:

EAC:WUP:COUN 10

Notes:

Command switches the calibrator in Energy AC mode.

[SOUR]:EDC:ENER?

This query returns the set value of energy using standard exponential format. Example: 100.60 Ws is returned as 1.006000e+002.

Note:

Query switches the calibrator in Energy DC mode.

[SOUR]:EDC:DEV?

This query returns deviation between tested energy meter and the calibrator. Calculation of deviation is based on pulses generated by energy meter. Example: 0.612 % is returned as 6.120000e-001.

Note:

Query switches the calibrator in Energy DC mode.

[SOUR]:EDC:POW?

This query returns the set value of power using standard exponential format. Example: 100.60 W is returned as 1.006000e+002.

Note:

Query switches the calibrator in Energy DC mode.

[SOUR]:EDC:VOLT(?) <DNPD>

This command sets the output voltage value.

<DNPD>

Parameter represents the value of the output voltage expressed in V.

If query is sent, calibrator returns the value of output voltage using standard exponential format. Example: 110.12 V is returned as 1.101200e+002.

Example:

Voltage 230.5V:

EDC:VOLT 230.5

Note:

Command switches the calibrator in Energy DC mode.

[SOUR]:EDC:CURR(?) <DNPD>

This command sets the output current value in Energy DC mode.

<DNPD>

Parameter represents the value of the output current expressed in A.

If query is sent, calibrator returns the value of output current using standard exponential format. Example: 11.012 A is returned as 1.101200e+001.

Example:

Current 23.05A:

EDC:CURR 23.05

Note:

Command switches the calibrator in Energy DC mode.

[SOUR]:EDC:CONT(?) <CPD> { PACK | CNT1 | CNT2 | TIM1 | TIM2 | FR1 | FR2 | FR3}

This command selects energy counting control mode.

<CPD>

represents the control mode of energy counting.

- PACK – Packet mode energy counting is controlled by time to deliver specific “Packet” of energy
- CNT1 – energy counting mode is controlled by pulses on input 1
- CNT2 – energy counting mode is controlled by pulses on input 2
- TIM1 – energy timer mode is controlled by pulses on input 1
- TIM2 – energy timer mode is controlled by pulses on input 2
- FR1 – frequency measuring on input 1
- FR2 – frequency measuring on input 2
- FR3 – frequency measuring on multimeter input V/COM

If query is sent, calibrator returns the selected control mode.

Example:

EDC:CONT PACK selects the Packet control mode which is controlled by time

Note:

Command switches the calibrator in Energy DC mode.

[SOUR]:EDC:TIME(?) <DNPD>

This command sets the time in Energy DC “Packet” control mode.

<DNPD>

Parameter represents the value of time expressed in s.

If query is sent, calibrator returns the value of time using standard exponential format. Example: 120s is returned as 1.200000e+002.

Example:

Time 60s:

```
EDC:TIME 60
```

Notes:

Command switches the calibrator in Energy DC mode.

[SOUR]:EDC:CONS(?) <DNPD>

This command sets number of pulses per one kWh (pulses generated by energy meter).

<DNPD>

Parameter represents the value number of pulses per one kWh.

If query is sent, calibrator returns set value using standard exponential format. Example: 400.0 i/kWh is returned as 4.000000e+002.

Example:

Number of pulses 1000 i/kWh:

```
EDC:CONS 1000.0
```

Note:

Command switches the calibrator in Energy DC mode.

[SOUR]:EDC:TEST:TIME (?) <DNPD>

This command sets test timer in Energy DC mode.

<DNPD>

Parameter represents test time when pulses are counted.

If query is sent, calibrator returns the value of time using standard exponential format. Example: 20 is returned as 2.000000e+001.

Example:

```
EDC:TEST:TIME 10
```

Notes:

Command switches the calibrator in Energy DC mode.

[SOUR]:EDC:TEST:COUN(?) <DNPD>

This command sets test pulse counter in Energy DC mode.

<DNPD>

Parameter represents number of test pulses to be counted.

If query is sent, calibrator returns number of pulse counts using standard exponential format. Example: 20 is returned as 2.000000e+001.

Example:

```
EDC:TEST:COUN 10
```

Notes:

Command switches the calibrator in Energy DC mode.

[SOUR]:EDC:TEST:FREQ? <DNPD>

This query returns actual frequency generated by tested energy meter.

<DNPD>

Parameter represents measured frequency.

Calibrator returns frequency using standard exponential format. Example: 20 is returned as 2.000000e+001.

Example:

```
EDC:TEST:FREQ?
```

Notes:

Command switches the calibrator in Energy DC mode.

[SOUR]:EDC:WUP:TIME (?) <DNPD>

This command sets warm-up timer in Energy DC mode.

<DNPD>

Parameter represents warm-up time when pulses are counted.

If query is sent, calibrator returns the value of time using standard exponential format. Example: 20 is returned as 2.000000e+001.

Example:

```
EDC:WUP:TIME 10
```

Notes:

Command switches the calibrator in Energy DC mode.

[SOUR]:EDC:WUP:COUN(?) <DNPD>

This command sets warm-up pulse counter in Energy DC mode.

<DNPD>

Parameter represents number of warm-up pulses to be counted.

If query is sent, calibrator returns number of pulse counts using standard exponential format. Example: 20 is returned as 2.000000e+001.

Example:

```
EDC:WUP:COUN 10
```

Notes:

Command switches the calibrator in Energy DC mode.

[SOUR]:EACI:ENER?

This query returns the set value of energy using standard exponential format. Example: 100.60 Ws is returned as 1.006000e+002.

Note:

Query switches the calibrator in Energy AC high current mode.

[SOUR]:EACI:DEV?

This query returns deviation between tested energy meter and the calibrator. Calculation of deviation is based on pulses generated by energy meter. Example: 0.612 % is returned as 6.120000e-001.

Note:

Query switches the calibrator in Energy AC high current mode.

[SOUR]:EACI:POW?

This query returns the set value of power using standard exponential format. Example: 100.60 W is returned as 1.006000e+002.

Note:

Query switches the calibrator in Energy AC high current mode.

[SOUR]:EACI[:POW]:UNIT(?) <CPD> { W | VA | VAR }

This command selects units for power in the Energy AC high current mode.

If query is sent, calibrator returns actual units in Energy AC high current mode.

Example:

Select unit W for Energy AC high current mode:

EACI:UNIT W

Note:

Command switches the calibrator in Energy AC high current mode.

[SOUR]:EACI:VOLT(?) <DNPD>

This command sets the output voltage value.

<DNPD>

Parameter represents the value of the output voltage expressed in V.

If query is sent, calibrator returns the value of output voltage using standard exponential format. Example: 110.12 V is returned as 1.101200e+002.

Example:

Voltage 230.5V:

EACI:VOLT 230.5

Note:

Command switches the calibrator in Energy AC high current mode.

[SOUR]:EACI:CURR(?) <DNPD>

This command sets the output current value in Energy AC high current mode.

<DNPD>

Parameter represents the value of the output current expressed in A.

If query is sent, calibrator returns the value of output current using standard exponential format. Example: 11.012 A is returned as 1.101200e+001.

Example:

Current 23.05A:

EACI:CURR 23.05

Note:

Command switches the calibrator in Energy AC high current mode.

[SOUR]:EACI[:CURR]:PHAS(?) <DNPD>

This command sets the phase angle between voltage and current.

<DNPD>

Represents the phase angle between the output voltage and current in degrees (PHAS:UNIT=DEG), or specified as a value of the power factor (PHAS:UNIT=COS).

If query is sent, calibrator returns the set value of the phase shift between the output voltage and current using standard exponential format. Example: 156.3 ° is returned as 1.563000e+002.

Example: EACI:PHAS 250.2 - sets 250.2° phase shift between the output voltage and current

(PHAS:UNIT=DEG) EACI:PHAS? - the calibrator returns 2.502000e+002

Example: EACI:PHAS 0.554 – sets power factor 0.554

(PHAS:UNIT=COS) EACI:PHAS? - the calibrator returns 5.540000e-001,LAG

Note:

Command switches the calibrator in Energy AC high current mode.

[SOUR]:EACI[:CURR]:POLarity(?) <CPD> { LEAD | LAG }

This command sets the polarity of phase angle between voltage and current. Command is valid only for PHAS:UNIT=DEG.

<CPD>

Represents the polarity of phase angle between the output voltage and current.

If query is sent, calibrator returns the polarity of the phase angle between the output voltage and current.

Example:

EACI:POL LEAD sets the phase angle polarity to Lead

Note:

Command switches the calibrator in Energy AC high current mode.

[SOUR]:EACI:FREQ(?) <DNPD>

This command sets the frequency in Energy AC high current mode.

<DNPD>

Parameter represents the value of frequency expressed in Hz.

If query is sent, calibrator returns the value of frequency using standard exponential format.

Example: 50Hz is returned as 5.000000e+001.

Example:

Frequency 60Hz:

EACI:FREQ 60

Notes:

Command switches the calibrator in Energy AC high current mode.

[SOUR]:EACI:CONT(?) <CPD> { PACK | CNT1 | CNT2 | TIM1 | TIM2 | FR1 | FR2 | FR3 }

This command selects energy counting control mode.

<CPD>

represents the control mode of energy counting.

- PACK – Packet mode energy counting is controlled by time to deliver specific “Packet” of energy
- CNT1 – energy counting mode is controlled by pulses on input 1
- CNT2 – energy counting mode is controlled by pulses on input 2
- TIM1 – energy timer mode is controlled by pulses on input 1
- TIM2 – energy timer mode is controlled by pulses on input 2
- FR1 – frequency measuring on input 1
- FR2 – frequency measuring on input 2
- FR3 – frequency measuring on multimeter input V/COM

If query is sent, calibrator returns the selected control mode.

Example:

EACI:CONT PACK selects the Packet control mode which is controlled by time

Note:

Command switches the calibrator in Energy AC high current mode.

[SOUR]:EACI:TIME(?) <DNPD>

This command sets the time in Energy AC high current “Packet” control mode.

<DNPD>

Parameter represents the value of time expressed in s.

If query is sent, calibrator returns the value of time using standard exponential format. Example: 120s is returned as 1.200000e+002.

Example:

Time 60s:

```
EACI:TIME 60
```

Notes:

Command switches the calibrator in Energy AC high current mode.

[SOUR]:EACI:CONS(?) <DNPD>

This command sets number of pulses per selected unit (pulses generated by energy meter).

<DNPD>

Parameter represents the value number of pulses per selected unit.

If query is sent, calibrator returns set value using standard exponential format. Example: 400.0 i/kWh is returned as 4.000000e+002.

Example:

Number of pulses 1000 i/kVArh:

```
EACI:CONS 1000.0
```

```
EACI:UNIT VAR
```

Note:

Command switches the calibrator in Energy AC high current mode.

[SOUR]:EACI:TEST:TIME (?) <DNPD>

This command sets test timer in Energy AC high current mode.

<DNPD>

Parameter represents test time when pulses are counted.

If query is sent, calibrator returns the value of time using standard exponential format. Example: 20 is returned as 2.000000e+001.

Example:

```
EACI:TEST:TIME 10
```

Notes:

Command switches the calibrator in Energy AC high current mode.

[SOUR]:EACI:TEST:COUN(?) <DNPD>

This command sets test pulse counter in Energy AC high current mode.

<DNPD>

Parameter represents number of test pulses to be counted.

If query is sent, calibrator returns number of pulse counts using standard exponential format. Example: 20 is returned as 2.000000e+001.

Example:

```
EACI:TEST:COUN 10
```

Notes:

Command switches the calibrator in Energy AC high current mode.

[SOUR]:EACI:TEST:FREQ? <DNPD>

This query returns actual frequency generated by tested energy meter.

<DNPD>

Parameter represents measured frequency.

Calibrator returns frequency using standard exponential format. Example: 20 is returned as 2.000000e+001.

Example:

```
EACI:TEST:FREQ?
```

Notes:

Command switches the calibrator in Energy AC high current mode.

[SOUR]:EACI:WUP:TIME (?) <DNPD>

This command sets warm-up timer in Energy AC high current mode.

<DNPD>

Parameter represents wrm-up time when pulses are counted.

If query is sent, calibrator returns the value of time using standard exponential format. Example: 20 is returned as 2.000000e+001.

Example:

```
EACI:WUP:TIME 10
```

Notes:

Command switches the calibrator in Energy AC high current mode.

[SOUR]:EACI:WUP:COUN(?) <DNPD>

This command sets warm-up pulse counter in Energy AC high current mode.

<DNPD>

Parameter represents number of warm-up pulses to be counted.

If query is sent, calibrator returns number of pulse counts using standard exponential format. Example: 20 is returned as 2.000000e+001.

Example:

```
EACI:WUP:COUN 10
```

Notes:

Command switches the calibrator in Energy AC high current mode.

[SOUR]:EDCI:ENER?

This query returns the set value of energy using standard exponential format. Example: 100.60 Ws is returned as 1.006000e+002.

Note:

Query switches the calibrator in Energy DC high current mode.

[SOUR]:EDCI:DEV?

This query returns deviation between tested energy meter and the calibrator. Calculation of deviation is based on pulses generated by energy meter. Example: 0.612 % is returned as 6.120000e-001.

Note:

Query switches the calibrator in Energy DC high current mode.

[SOUR]:EDCI:POW?

This query returns the set value of power using standard exponential format. Example: 100.60 W is returned as 1.006000e+002.

Note:

Query switches the calibrator in Energy DC high current mode.

[SOUR]:EDCI:VOLT(?) <DNPD>

This command sets the output voltage value.

<DNPD>

Parameter represents the value of the output voltage expressed in V.

If query is sent, calibrator returns the value of output voltage using standard exponential format. Example: 110.12 V is returned as 1.101200e+002.

Example:

Voltage 230.5V:

EDCI:VOLT 230.5

Note:

Command switches the calibrator in Energy DC high current mode.

[SOUR]:EDCI:CURR(?) <DNPD>

This command sets the output current value in Energy DC high current mode.

<DNPD>

Parameter represents the value of the output current expressed in A.

If query is sent, calibrator returns the value of output current using standard exponential format. Example: 11.012 A is returned as 1.101200e+001.

Example:

Current 23.05A:

EDCI:CURR 23.05

Note:

Command switches the calibrator in Energy DC high current mode.

[SOUR]:EDCI:CONT(?) <CPD> { PACK | CNT1 | CNT2 | TIM1 | TIM2 | FR1 | FR2 | FR3}

This command selects energy counting control mode.

<CPD>

represents the control mode of energy counting.

- PACK – Packet mode energy counting is controlled by time to deliver specific “Packet” of energy
- CNT1 – energy counting mode is controlled by pulses on input 1
- CNT2 – energy counting mode is controlled by pulses on input 2
- TIM1 – energy timer mode is controlled by pulses on input 1
- TIM2 – energy timer mode is controlled by pulses on input 2
- FR1 – frequency measuring on input 1
- FR2 – frequency measuring on input 2
- FR3 – frequency measuring on multimeter input V/COM

If query is sent, calibrator returns the selected control mode.

Example:

EDCI:CONT PACK selects the Packet control mode which is controlled by time

Note:

Command switches the calibrator in Energy DC high current mode.

[SOUR]:EDCI:TIME(?) <DNPD>

This command sets the time in Energy DC high current “Packet” control mode.

<DNPD>

Parameter represents the value of time expressed in s.

If query is sent, calibrator returns the value of time using standard exponential format. Example: 120s is returned as 1.200000e+002.

Example:

Time 60s:

EDCI:TIME 60

Notes:

Command switches the calibrator in Energy DC high current mode.

[SOUR]:EDCI:CONS(?) <DNPD>

This command sets number of pulses per one kWh (pulses generated by energy meter).

<DNPD>

Parameter represents the value number of pulses per one kWh.

If query is sent, calibrator returns set value using standard exponential format. Example: 400.0 i/kWh is returned as 4.000000e+002.

Example:

Number of pulses 1000 i/kWh:

```
EDCI:CONS 1000.0
```

Note:

Command switches the calibrator in Energy DC high current mode.

[SOUR]:EDCI:TEST:TIME (?) <DNPD>

This command sets test timer in Energy DC high current mode.

<DNPD>

Parameter represents test time when pulses are counted.

If query is sent, calibrator returns the value of time using standard exponential format. Example: 20 is returned as 2.000000e+001.

Example:

```
EDCI:TEST:TIME 10
```

Notes:

Command switches the calibrator in Energy DC high current mode.

[SOUR]:EDCI:TEST:COUN(?) <DNPD>

This command sets test pulse counter in Energy DC high current mode.

<DNPD>

Parameter represents number of test pulses to be counted.

If query is sent, calibrator returns number of pulse counts using standard exponential format. Example: 20 is returned as 2.000000e+001.

Example:

```
EDCI:TEST:COUN 10
```

Notes:

Command switches the calibrator in Energy DC high current mode.

[SOUR]:EDCI:TEST:FREQ? <DNPD>

This query returns actual frequency generated by tested energy meter.

<DNPD>

Parameter represents measured frequency.

Calibrator returns frequency using standard exponential format. Example: 20 is returned as 2.000000e+001.

Example:

```
EDCI:TEST:FREQ?
```

Notes:

Command switches the calibrator in Energy DC high current mode.

[SOUR]:EDCI:WUP:TIME (?) <DNPD>

This command sets warm-up timer in Energy DC high current mode.

<DNPD>

Parameter represents wrm-up time when pulses are counted.

If query is sent, calibrator returns the value of time using standard exponential format. Example: 20 is returned as 2.000000e+001.

Example:

```
EDCI:WUP:TIME 10
```

Notes:

Command switches the calibrator in Energy DC high current mode.

[SOUR]:EDCI:WUP:COUN(?) <DNPD>

This command sets warm-up pulse counter in Energy DC high current mode.

<DNPD>

Parameter represents number of warm-up pulses to be counted.

If query is sent, calibrator returns number of pulse counts using standard exponential format. Example: 20 is returned as 2.000000e+001.

Example:

```
EDCI:WUP:COUN 10
```

Notes:

Command switches the calibrator in Energy DC high current mode.

[SOUR]:VAC:VOLT(?) <DNPD>

This command sets the output voltage value in Voltage AC mode.

<DNPD>

Parameter represents the value of the output voltage expressed in V.

If query is sent, calibrator returns the value of output voltage using standard exponential format.
Example: 110.12 V is returned as 1.101200e+002.

Example:

Voltage 230.5V:

VAC:VOLT 230.5

Note:

Command switches the calibrator in Voltage AC mode.

[SOUR]:VAC:FREQ(?) <DNPD>

This command sets the frequency in Voltage AC mode.

<DNPD>

Parameter represents the value of frequency expressed in Hz.

If query is sent, calibrator returns the value of frequency using standard exponential format.
Example: 50Hz is returned as 5.000000e+001.

Example:

Frequency 60Hz:

VAC:FREQ 60

Notes:

Command switches the calibrator in Voltage AC mode.

[SOUR]:VDC:VOLT(?) <DNPD>

This command sets the output voltage value in Voltage DC mode.

<DNPD>

Parameter represents the value of the output voltage expressed in V.

If query is sent, calibrator returns the value of output voltage using standard exponential format.
Example: 110.12 V is returned as 1.101200e+002.

Example:

Voltage 230.5V:

VDC:VOLT 230.5

Note:

Command switches the calibrator in Voltage DC mode.

[SOUR]:CAC:CURR(?) <DNPD>

This command sets the output current value in Current AC mode.

<DNPD>

Parameter represents the value of the output current expressed in A.

If query is sent, calibrator returns the value of output current using standard exponential format.
Example: 11.012 A is returned as 1.101200e+001.

Example:

Current 23.05A:

CAC:CURR 23.05

Note:

Command switches the calibrator in Current AC mode.

[SOUR]:CAC:FREQ(?) <DNPD>

This command sets the frequency in Current AC mode.

<DNPD>

Parameter represents the value of frequency expressed in Hz.

If query is sent, calibrator returns the value of frequency using standard exponential format.

Example: 50Hz is returned as 5.000000e+001.

Example:

Frequency 60Hz:

CAC:FREQ 60

Notes:

Command switches the calibrator in Current AC mode.

[SOUR]:CDC:CURR(?) <DNPD>

This command sets the output voltage value in Current DC mode.

<DNPD>

Parameter represents the value of the output current expressed in A.

If query is sent, calibrator returns the value of output voltage using standard exponential format.

Example: 11.012 A is returned as 1.101200e+001.

Example:

Current 23.05A:

CDC:CURR 23.05

Note:

Command switches the calibrator in Current DC mode.

[SOUR]:CACI:CURR(?) <DNPD>

This command sets the output current value in Current AC high current mode.

<DNPD>

Parameter represents the value of the output current expressed in A.

If query is sent, calibrator returns the value of output current using standard exponential format.

Example: 11.012 A is returned as 1.101200e+001.

Example:

Current 23.05A:

CACI:CURR 23.05

Note:

Command switches the calibrator in Current AC high current mode.

[SOUR]:CACI:FREQ(?) <DNPD>

This command sets the frequency in Current AC high current mode.

<DNPD>

Parameter represents the value of frequency expressed in Hz.

If query is sent, calibrator returns the value of frequency using standard exponential format.

Example: 50Hz is returned as 5.000000e+001.

Example:

Frequency 60Hz:

CACI:FREQ 60

Notes:

Command switches the calibrator in Current AC high current mode.

[SOUR]:CDCI:CURR(?) <DNPD>

This command sets the output voltage value in Current DC high current mode.

<DNPD>

Parameter represents the value of the output current expressed in A.

If query is sent, calibrator returns the value of output voltage using standard exponential format.

Example: 11.012 A is returned as 1.101200e+001.

Example:

Current 23.05A:

CDCI:CURR 23.05

Note:

Command switches the calibrator in Current DC high current mode.

SYSTem subsystem

The subsystem enables to control various functions from the MENU.

SYSTem

:DATE(?)	<DNPD>,<DNPD>,<DNPD>
:TIME(?)	<DNPD>,<DNPD>,<DNPD>
:ERRor?	
:REMote	
:RWLock	
:LOCal	

SYST:DATE(?) <DNPD>,<DNPD>,<DNPD>

This command sets system date of the calibrator.

<DNPD>,<DNPD>,<DNPD>

Represents date in format YYYY, MM, DD.

If query is sent, calibrator returns current value of system date in format YYYY,MM,DD.

where YYYY = year (2000..2099)

MM = month (01..12)

DD = day (01..31)

SYST:TIME(?) <DNPD>,<DNPD>,<DNPD>

This command sets time of the calibrator.

<DNPD>,<DNPD>,<DNPD>

Represents time in format HH,MM,SS.

If query is sent, calibrator returns current value of system time in format HH,MM,SS.

where HH = hour (00..23)

MM = minute (00..59)

SS = second (00..59)

SYST:ERR?

Query the multimeter's error queue. Detected errors are placed in the queue. This query returns the first error from the queue. The queue is type "first in, first out". The error is deleted after reading.

The response is in the form of 'String Program Data', and consists of two elements: a code number and error message.

If all errors are read calibrator returns message 0,"No Error".

In case of overflow the error queue the last error in the queue is -350,"Queue overflow". Also the earliest errors remain in the queue, and the most recent error is discarded.

Example:

SYST:ERR?

SYST:REM

This command places the calibrator in the remote mode for RS232 or Ethernet operation. All keys on the front panel, except the LOCAL key, are disabled.

Note:

It is not possible to send or receive data over RS232 or Ethernet when the calibrator is not in remote mode.

SYST:RWL

This command places the calibrator in the remote mode for RS232 or Ethernet operation. All keys on the front panel, including the LOCAL key, are disabled.

SYST:LOC

This command returns the calibrator in the local mode. This command is for RS232 and Ethernet interfaces.

STATus subsystem

This subsystem is used to enable bits in the Operation and Questionable Event registers. The Operation and Questionable: Event, Enable and Condition registers can be interrogated to determine their state.

STATus

```

:OPERational
  :EVENT?
  :ENABle(?)      <DNPd>
  :CONDition?

:QUEStionable
  :EVENT?
  :ENABle(?)      <DNPd>
  :CONDition?

:PRESet

```

STAT:OPER:EVENT?

This query returns the content of Operational Data Event register. It is a decimal value which corresponds to the binary-weighted sum of all bits set in the register. Register is cleared after this query.

Example:

```
STAT:OPER:EVENT?
```

STAT:OPER:ENAB? <DNPd>

This command enables bits in the Operational Data Enable register. Selected bits are summarized at bit 7 (OSS) of the IEEE488.2 Status Byte register.

<DNPd>

Parameter represents required value of Operational Data Enable register.

If query is sent, calibrator returns the value of the register as a decimal number. Example: 64 is returned as 64.

Example:

Set bit 1 in the Operational Data Enable register (other bits are 0):

```
STAT:OPER:ENAB 2
```

STAT:OPER:COND?

This query returns the content of Operational Condition register. It is a decimal value which corresponds to the binary-weighted sum of all bits in the register. Register is not cleared after this query. The response to the query therefore represents an instantaneous 'Snapshot' of the register state, at the time that the query was accepted.

Example:

```
STAT:OPER:COND?
```

STAT:QUES:EVEN?

This query returns the content of Questionable Data Event register. It is a decimal value which corresponds to the binary-weighted sum of all bits set in the register. Register is cleared after this query.

Example:

```
STAT:QUES:EVEN?
```

STAT:QUES:ENAB? <DNPD>

This command enables bits in the Questionable Data Enable register. Selected bits are summarized at bit 3 (QSS) of the IEEE488.2 Status Byte register.

<DNPD>

Parameter represents required value of Questionable Data Enable register.

If query is sent, calibrator returns the value of the register as a decimal number. Example: 64 is returned as 64.

Example:

Set bit 1 in the Questionable Data Enable register (other bits are 0):

```
STAT:QUES:ENAB 2
```

STAT:QUES:COND?

This query returns the content of Questionable Condition register. It is a decimal value which corresponds to the binary-weighted sum of all bits in the register. Register is not cleared after this query. The response to the query therefore represents an instantaneous 'Snapshot' of the register state, at the time that the query was accepted.

Example:

```
STAT:QUES:COND?
```

STAT:PRES

This command clears all bits in the Operation Data Enable register and in the Questionable Data Enable register.

Example:

```
STAT:PRES
```

IEEE488.2 Common Commands

I/D (instrument identification)

***IDN?**

This command returns the identification of the manufacturer, model, serial number and firmware revision.

The reply is formatted as follows:
MEATEST,M133C,100002,1.22

Operation complete

***OPC**

This command sets the OPC bit in the ESR (Event Status Register) when all pending operations are complete.

Operation complete?

***OPC?**

This command returns “1” to the output queue after all pending operations are complete.

Option identification?

***OPT?**

This command return the instrument’s hardware fitment.

The reply is formatted as follows:
1,a2,a3,0,0,0,0

Where:

1 .. indicates that the main unit (channel #1) is fitted –must be

a1 ... indicates that additional unit (channel #2) is fitted

a2 ... indicates that additional unit (channel #3) is fitted

0 ... position reserved for future use.

a1 = 0 ... unit channel #2 is not fitted

a1 = 1 ... unit channel #2 is fitted

a2 = 0 ... unit channel #3 is not fitted

a2 = 1 ... unit channel #3 is fitted

Wait-to-Continue command***WAI**

Prevents the instrument from executing any further commands or queries until all previous remote commands have been executed.

Reset***RST**

This command resets the calibrator to its initial status.

Test operation***TST?**

This command launches an internal self-test. Return the self-test result (“0” for pass or “1” for fail).

Status byte reading***STB?**

This query returns number in range 0 to 255 with information about content of register STB, which carries the MSS bit status.

Service Request Enable***SRE <value>**

This command sets condition of the Service Request Enable register. Since bit 6 is not used, the maximum value is 191.

Service Request Enable reading***SRE?**

This query returns the Service Request Enable Register number.

Event Status Register reading***ESR?**

This query returns the contents of the Event Status Register and clears the register.

Event Status Enable setting

***ESE <value>**

This command programs the Event Status Enable register bits. Parameter “value” is number in range 0 – 255.

Event Status Enable reading

***ESE?**

This query returns the Event Status Enable register.

Clear status

***CLS**

This command clears the Event Status Register and the Status Byte Register except the MAV bit and output queue. Output line is not reset.

11.4 Standard Status Data Structures

Calibrator meets standard protocol according to the standard IEEE488.2. The protocol can be used for checking of error and status behavior of the calibrator. It enables single-wire transmitting of SRQ command. The conditions on which SRQ signal (local control request) is sent can be set with parameters *STB?, *SRE?, *SRE, *ESR?, *ESE?, *ESE a *CLS.

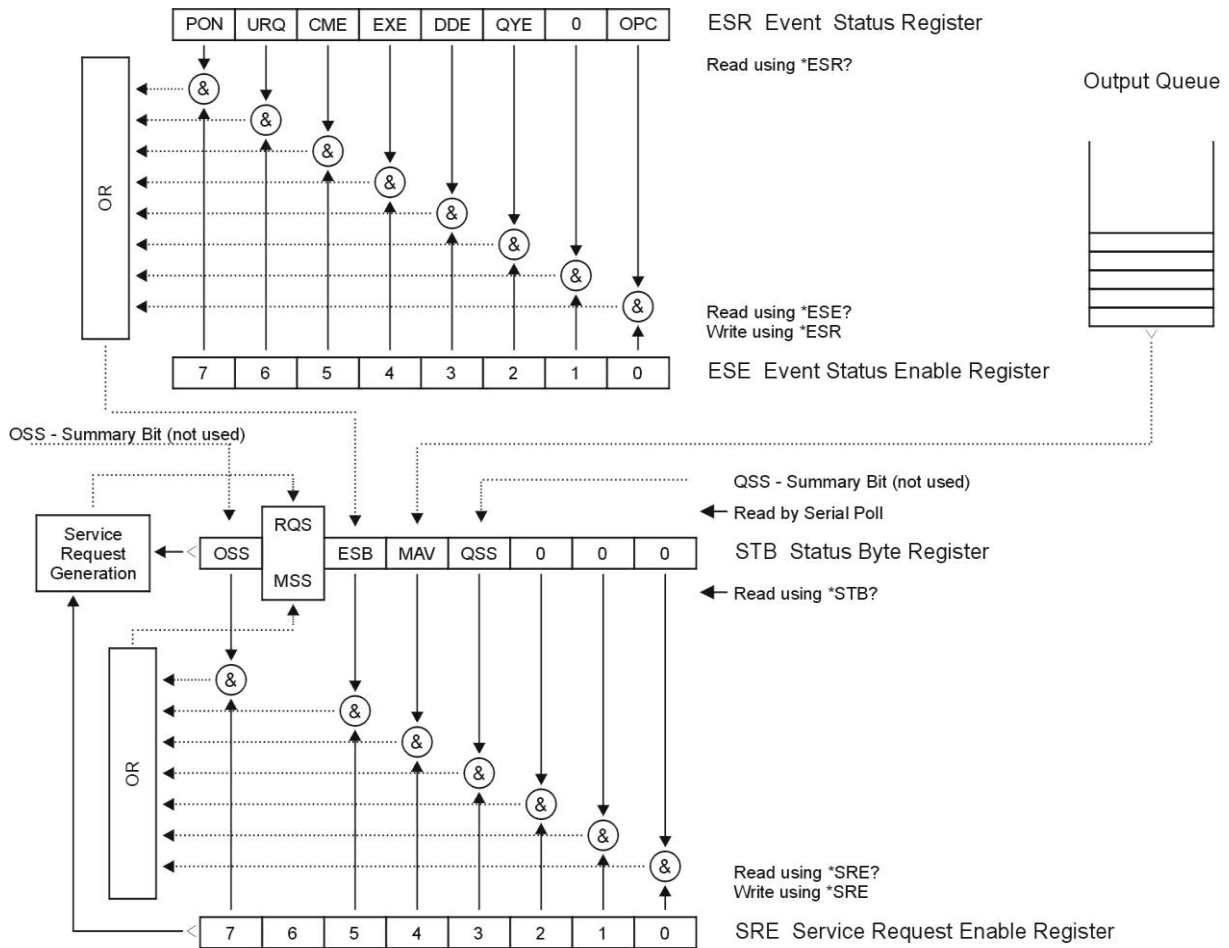

Status Register Overview

Status data structure contains following registers:

- STB – Status Byte Register
- SRE – Service Request Enable Register
- ESR – Event Status Register
- ESE – Event Status Enable Register
- Output Queue

STB Status Byte Register

STB is main register where information from other status registers and from output queue is collected. Value of STB register is reset after switching on the calibrator or after sending command *CLS. This command reset the STB register except bit MAV, which remains set if the output queue is not empty. STB register value can be read via serial message or through general query *STB? .

Bit configuration of Status Byte Register :

- OSS Operation Summary Status, bit 7. SCPI-defined. The OSS bit is set to 1 when the data in the OSR (Operation Status Register) contains one or more enabled bits which are true.
- RQS Request Service, bit 6. The bit is read as a part of status byte only when serial message is sent.
- MSS Master Summary Status, bit 6. The MSS bit is set to 1 whenever bits ESB or MAV are 1 and enabled (1) in the SRE. This bit can be read using the *STB? command. His value is derived from STB and SRE status.
- ESB Event Summary Bit, bit 5. His value is derived from STB and SRE status. The ESB bit is set to 1 when one or more enabled ESR bits are set to 1.
- MAV Message Available, bit 4. The MAV bit is set to 1 whenever data is available in the IEEE488 Output Queue (the response on query is ready).
- QSS Questionable Summary Status, bit 3. SCPI-defined. The QSS bit is set to 1 when the data in the QSR (Questionable Status Register) contains one or more enabled bits which are true.

SRE Service Request Enable Register

The Service Request Enable Register suppresses or allows the STB bits. “0” value of a SRE bit means, that the bit does not influence value of MSS bit. Value of any unmask STB bit results in setting of the MSS bit to the level “1” . SRE bit 6 is not influenced and its value is “0”. The SRE register value can be set via the command *SRE followed by mask register value (0 – 191). The register can be read with the command *SRE?. The register is automatically resets after switching the calibrator on. The register is not reset by the command *CLS.

ESR Event Status Register

Every bit of the EventStatusRegister corresponds to one event. Bit is set when the event is changed and it remains set also when the event passed. The ESR is cleared when the power is turned on (except bit PON which is set), and every time it is read via command *ESR? Or cleared with *CLS.

Bit configuration of Event Status Register :

- PON Power On, bit 7. This event bit indicates that an off-to-on transition has occurred in the device’s power supply.
- URQ User Request, bit 6. Bit is not used and it is always “0”.

- CME** Command Error, bit 5. This event bit indicates that an incorrectly formed command or query has been detected by the instrument.
- EXE** Execution Error, bit 4. This event bit indicates that the received command cannot be executed, owing to the device state or the command parameter being out of limits.
- DDE** Device Dependent Error, bit 3. This event bit indicates that an error has occurred which is neither a Command Error, a Query Error, nor an Execution Error. A Device-specific Error is any executed device operation that did not properly complete due to some condition, such as overload.
- QYE** Query Error, bit 2. The bit is set if the calibrator is addressed as talker and output queue is empty or if control unit did not pick up response before sending next query.
- OPC** Operation Complete, bit 0. This event bit is generated in response to the *OPC command. It indicates that the device has completed all selected pending operations.

ESE Event Status Enable Register

The Event Status Enable Register allows one or more events in the Event Status Register to be reflected in the ESB summary-message bit. This register is defined for 8 bits, each corresponding to the bits in the Event Status Register. The Event Status Enable Register is read with the common query *ESE?. Data is returned as a binary-weighted value. The Event Status Enable Register is written to by the common command, *ESE. Sending the *ESE common command followed by a zero clears the ESE. The Event Status Enable Register is cleared upon power-on.

It suppresses or allows bits in ESR register. Value „0“ of a bit of ESE register suppresses influence of appropriate bit of ESR register on value of sum bit of ESB status register. Setting of any unmask bit of ESR register results in setting of ESB status register. ESE register value can be modified by command *ESE followed by value of mask register (integer in range 0 –255). Reading of the register can be performed with command *ESE?. The register is automatically reset after switching on. The register is not reset with *CLS command.

Operation Status Register

Not used in the calibrator.

Questionable Status Register

Not used in the calibrator.

Output Queue

The Output Queue stores response messages until they are read from control unit. If there is at minimum one sign in the output queue, MAV register (message available) is set. The Output Queue is cleared upon power-on and after reading all signs from output queue.

Error Queue

The Error Queue stores error messages. They are placed in a “first in, first out” queue. The queue is read destructively using the query command “SYSTem:ERRor?” to obtain a code number and error message. The query “SYSTem:ERRor?” can be used to read errors in the queue until it is empty, when the message “0, No Error” will be returned.

12 Specification

Uncertainties include long-term stability, temperature coefficient, linearity, load and line regulation and the traceability of factory and National calibration standards. Specified accuracy is valid after one hour warm up in temperature range 23 ± 2 °C. Specified accuracy is one year accuracy.

DC/AC voltage (sine amplitude)

Summary range:	1 to 600 Vac, 1 to 280 Vdc
Voltage resolution:	5½ dig.
Frequency range:	DC, 15 Hz to 1000 Hz
Frequency accuracy:	0.005%
Frequency resolution:	0.001 Hz below 500 Hz, 0.01 Hz below 1000 Hz
Distortion:	< 0.05 %

Range	% value + % range	Max. burden (mA)*	% value + % range	Max. burden (mA)*	% value + % range	Max. burden (mA)*
	DC		15 – 40 Hz 70 – 1000 Hz		40 - 70 Hz	
1.0000 - 10.0000 V	0.015 + 0.01	100	0.02 + 0.01	100	0.015 + 0.01	100
10.0001 – 30.0000 V	0.015 + 0.01	200	0.02 + 0.01	200	0.015 + 0.01	200
30.001 – 70.000 V	0.015 + 0.01	200	0.02 + 0.01	200	0.015 + 0.01	300
70.001 – 140.000 V	0.015 + 0.01	200	0.02 + 0.01	200	0.015 + 0.01	300
140.001 – 280.000 V	0.015 + 0.01	150	0.02 + 0.01	150	0.015 + 0.01	200
280.001 – 600.000 V**	--	--	0.03 + 0.01	50	0.02 + 0.01	60

* sum of all currents (three phases) is limited to 400mA

** only fundamental harmonic in range over 280Vac, frequency range 20 – 1000 Hz

DC/AC current (sine amplitude)

Summary range:	5 mA to 30 A
Current resolution:	5½ dig.
Frequency range:	DC, 15 Hz to 1000 Hz
Frequency accuracy:	0.005%
Frequency resolution:	0.001 Hz below 500 Hz, 0.01 Hz below 1000 Hz
Distortion:	< 0.1 %

Range	% value + % range	Max. compliance voltage (V)	% value + % range		Max. compliance voltage (V)	
	DC		15 - 40 Hz 70 – 1000 Hz	40 - 70 Hz	15 – 400 Hz	400 – 1000 Hz
0.005000 - 0.300000 A	0.025 + 0.01	8	0.03 + 0.02	0.025 + 0.01	5.5	3.5
0.30001 - 1.00000 A	0.025 + 0.01	8	0.03 + 0.02	0.025 + 0.01	5.5	3.5
1.00001 - 2.00000 A	0.025 + 0.01	8	0.03 + 0.02	0.025 + 0.01	5.5	3.5
2.00001 - 5.00000 A	0.025 + 0.01	5	0.03 + 0.02	0.025 + 0.01	3.5	3.5
5.0001 - 10.0000 A	0.03 + 0.015	5	0.04 + 0.02	0.03 + 0.015	3.5	3.5
10.0001 - 30.0000 A	0.035 + 0.015	5	0.05 + 0.02	0.035 + 0.015	3.5	3.5

When option 140-50 Current Coil is used, add 0.3% to the accuracy specified in the table above. Output current is multiplied by factor 25 or 50 depending on applied coil range.

Relative accuracy in “**High Current Modes**” (output current up to 90A) is numerically the same as relative accuracy in standard current modes for three times lower current. Example: Relative accuracy for current 90Adc in High Current mode is the same as relative accuracy for current 30Adc in Standard mode (0.05%).

Phase and power factor (sine amplitude)

Phase range:	0.0° to 359.99°
Frequency range:	15 Hz to 1000 Hz
Phase resolution:	0.01°
Power factor range:	-1 to +1 (Lead, Lag)
Power factor resolution:	0.001
Power factor accuracy:	$dPF = (1 - \cos(\varphi + d\varphi)) / \cos \varphi$ (-)

Phase accuracy φ *

Frequency (Hz)	Current (A)	Phase accuracy $d\varphi$ (°)
15.000 – 70.000	0.1 - 10	0.02
15.000 – 70.000	0.008 – 0.029999	0.1
15.000 – 70.000	0.030 – 0.099999 10.0001 - 30	0.05
70.001 – 400.000	0.008 - 30	0.1
400.001 – 1000.00	0.008 - 30	0.4
15.000 – 400.000	0.005 – 0.007999	0.4
400.001 – 1000.00	0.005 – 0.007999	1.0

* Table valid for internal frequency synchronization. Add stability of external signal for external synchronization.

DC power

Summary range:	0.005W to 8400 W (280 kW with current coil option 140-50)
Power unit:	W

DC electric power accuracy (%)					
Current	Voltage				
	10.0000 V	30.0000 V	70.000 V	140.000 V	280.000 V
100.000 mA	0.061	0.061	0.061	0.061	0.061
1.00000 A	0.044	0.044	0.044	0.044	0.044
5.00000 A	0.044	0.044	0.044	0.044	0.044
10.0000 A	0.052	0.052	0.052	0.052	0.052
30.0000 A	0.057	0.057	0.057	0.057	0.057

AC power (sine amplitude)

Summary range: 3x (0.005VA to 18 kVA (600 kVA with current coil option 140-50))

Frequency range: 15Hz to 1000 Hz

AC real power accuracy (%) for PF = 1.0 f = 40 – 70 Hz						
Current	Voltage					
	10.0000 V	30.0000 V	70.000 V	140.000 V	280.000 V	600.000 V
100.000 mA	0.061	0.061	0.061	0.061	0.061	0.063
1.00000 A	0.044	0.044	0.044	0.044	0.044	0.047
5.00000 A	0.044	0.044	0.044	0.044	0.044	0.047
10.0000 A	0.052	0.052	0.052	0.052	0.052	0.055
30.0000 A	0.057	0.057	0.057	0.057	0.057	0.059
AC electric power accuracy (%) for PF = 0.8 f = 40 – 70 Hz						
Current	Voltage					
	10.0000 V	30.0000 V	70.000 V	140.000 V	280.000 V	600.000 V
100.000 mA	0.067	0.067	0.067	0.067	0.067	0.069
1.00000 A	0.051	0.051	0.051	0.051	0.051	0.054
5.00000 A	0.051	0.051	0.051	0.051	0.051	0.054
10.0000 A	0.059	0.059	0.059	0.059	0.059	0.061
30.0000 A	0.087	0.087	0.087	0.087	0.087	0.088
AC electric power accuracy (%) for PF = 0.5 f = 40 – 70 Hz						
Current	Voltage					
	10.0000 V	30.0000 V	70.000 V	140.000 V	280.000 V	600.000 V
100.000 mA	0.086	0.086	0.086	0.086	0.086	0.088
1.00000 A	0.075	0.075	0.075	0.075	0.075	0.077
5.00000 A	0.075	0.075	0.075	0.075	0.075	0.077
10.0000 A	0.080	0.080	0.080	0.080	0.080	0.082
30.0000 A	0.16	0.16	0.16	0.16	0.16	0.16

(Real) Power accuracy calculation:

$$dP_W = \sqrt{(dU^2 + dI^2 + dPF^2 + 0.01^2)} (\%)$$

Reactive Power accuracy calculation:

$$dP_{VAR} = \sqrt{(dU^2 + dI^2 + dPF_{VAR}^2 + 0.01^2)} (\%)$$

Apparent Power accuracy calculation:

$$dP_{VA} = \sqrt{(dU^2 + dI^2 + 0.01^2)} (\%)$$

DC Power accuracy calculation:

$$dP_{Wdc} = \sqrt{(dU^2 + dI^2 + 0.01^2)} (\%)$$

Where:

$$dPF = \text{abs}(100 * (1 - \cos(\varphi + d\varphi) / \cos \varphi)) [\%]$$

$$dPF_{VAR} = \text{abs}(100 * (1 - \sin(\varphi + d\varphi) / \sin \varphi)) [\%]$$

 φ is set phase [°]

dU is accuracy of set voltage [%]

dI is accuracy of set current [%]

d φ is accuracy of set phase [°]**Example1** (Real power accuracy calculation, U=230V, I=5A, $\varphi=60^\circ$, f=50Hz):

$$dU = 0.015\% + 0.01\% * 280/230 = 0.0272\%$$

$$dI = 0.025\% + 0.01\% * 5/5 = 0.035\%$$

$$dPF = \text{abs}(100 * (1 - \cos(60^\circ + 0.02^\circ) / \cos(60^\circ))) = 0.0605\%$$

$$dP_W = \sqrt{(0.0272^2 + 0.035^2 + 0.0605^2 + 0.01^2)}\% = \mathbf{0.076\%}$$

Example2 (Reactive power accuracy calculation, U=230V, I=5A, $\varphi=60^\circ$, f=50Hz):

$$dU = 0.015\% + 0.01\% * 280/230 = 0.0272\%$$

$$dI = 0.025\% + 0.01\% * 1/1 = 0.035\%$$

$$dPF_{VAR} = \text{abs}(100 * (1 - \sin(60^\circ + 0.02^\circ) / \sin(60^\circ))) = 0.0201\%$$

$$dP_{VAR} = \sqrt{(0.0272^2 + 0.035^2 + 0.0201^2 + 0.01^2)}\% = \mathbf{0.050\%}$$

DC/AC energy (sine amplitude)

Voltage range:	1 to 280 Vdc (600 Vac)	Time range:	1 to 1e8 s
Current range:	5 mA to 30 A	Time resolution:	0.1 s
Power factor range:	- 1 to + 1	Time interval accuracy:	0.01 % + 0.1 s
		Max counts:	4e9

Energy accuracy calculation

In Packet control mode:

In Counter, Timer and Free run control modes:

$$dE = \sqrt{(dP^2 + dt^2)} (\%)$$

$$dE = dP (\%)$$

Where:

dP is accuracy of set power [%]

dt is accuracy of selected time interval [%]

Non harmonic signals (model M133C only)

Harmonic and interharmonic distortion (H/I products)

Fundamental harmonic frequency range:	15 Hz to 1 kHz
Fundamental harmonic amplitude accuracy:	0.2 % of range
Harmonics (2-50) frequency range:	30 Hz to 5 kHz
Interharmonic frequency range:	15 Hz to 1 kHz
Max. of harmonic products:	50
Number of interharmonic products:	1
Frequency accuracy:	0.005 %
Fundamental harmonic phase accuracy:	0.2° for 15.000 Hz - 70.000 Hz 0.5° for 70.001 Hz - 400.000 Hz 1° for 400.001 Hz - 1000.00 Hz
Harmonics (2-50) phase accuracy:	5 us (typical value, not guaranteed)
Amplitude range of H/I products:	max. 30% of RMS output value
Amplitude resolution of H/I products:	0.001 %
Noise & Distortion:	- 60 dB

Amplitude accuracy of H/I products

Range	% of range	
	30 - 3000 Hz	3000 - 5000 Hz
1.0000 - 10.0000 V	0.1	0.2
10.0001 - 30.0000 V		
30.001 - 70.000 V		
70.001 - 140.000 V		
140.001 - 280.000 V		
0.005000 - 0.300000 A	0.1	0.2
0.30001 - 1.00000 A		
1.00001 - 2.00000 A		
2.00001 - 5.00000 A	0.2	0.4
5.0001 - 10.0000 A		
10.0001 - 30.0000 A	0.2	0.8

Modulation (Flicker)

Fundamental harmonic frequency range:	15 Hz to 1 kHz
Single harmonic (2-50) frequency range:	30 Hz to 5 kHz
Modulation frequency range:	0.001 Hz to 50 Hz
Modulation depth:	0 to 30%
Modulation depth resolution:	0.001%
RMS amplitude accuracy:	0.2 % of range
Waveform of modulation signal:	sinus, rectangular
Modulation depth accuracy:	0.2 %

Dip/Swell

AC voltage range:	0.1 V to 280 V
AC current range:	1 mA to 30 A
Amplitude accuracy:	0.2 % of range ^{*1}
Frequency range:	15 Hz to 1 kHz
Timing ^{*2}	
t1 range:	0 s to 60 s
t2 range:	0.1 ms to 60 s
t3 range:	2 ms to 60 s
t4 range:	0.1 ms to 60 s
t5 range:	0 s to 60 s

^{*1} range is selected according to the highest value of output signal

^{*2} t1 + t5 > 2 ms

Multimeter

Function	Total range	Accuracy	Resolution / Range
DC voltage	0 to ±12 V	0.01 % + 0.01 %	100µV / 10V
DC current	0 to ±25 mA	0.01 % + 0.01 %	100 nA/20mA
Frequency	1 Hz to 15 kHz	0.005 %	10 µHz – 0.1 Hz

Auxiliary inputs***Input IN1 (energy pulses, synchronization)***

Max frequency	1 MHz (400 Hz for debounced input)
Min pulse width	500 ns
Input low level max	0.8 V
Input high level min	3.2 V
Internal pull-up values	150 Ω / 1 k Ω to 5V nominal

Input IN2 (energy pulses, synchronization)

Max frequency	10 kHz
Input low level max	0.8 V
Input high level min	3.5 V

Input IN3 (trigger, synchronization)

Min pulse width	10 μ s
Input low level max	0.8 V
Input high level min	3.5 V

General data

Warm up time:	60 min
Operating temperature:	23 \pm 10 $^{\circ}$ C, humidity < 80 %
Storage temperature:	-10 to 55 $^{\circ}$ C, humidity < 90 %
Reference temperature:	23 \pm 2 $^{\circ}$ C
Temperature coefficient:	0.1x spec / $^{\circ}$ C outside reference temperatures
Dimensions:	500(D) x 520(W) x 430(H) mm
Netto weight:	59 kg (M133C Three phase version) 37 kg (M133C Single phase version)
Power supply:	115/230V +/- 10%, 47...63 Hz
Power consumption:	max. 1875 VA
Safety class:	I, according EN 1010
Languages:	English, Chinese (simplified)

13 Versions & Options

M133C 3 phase	Three phase, extended version with power quality
M133Ci 3 phase	Three phase, sine wave base version
M133C 1 phase	Single phase, extended version with power quality
M133Ci 1 phase	Single phase, sine wave base version

Delivered with EU plug. Can be swapped for other types on demand.

14 Accessories

Basic accessories (included in delivery)

- Power line cord 1 pc
- User's manual 1 pc
- Test report 1 pc
- Spare fuse 1 pc
- Test cable banana-banana 1000V - 32 A, black 3 (1) pcs
- Test cable banana-banana 1000V - 32 A, red 3 (1) pcs
- Test cable banana-banana 1000V - 32 A, blue 3 (1) pcs
- Test cable banana-banana 1000V - 32 A, yellow 3 (1) pcs
- M133C-01 High Current Adapter 1 (0) pc
- RS232 cable 1 pc
- CD (Documentation, PowerAssistant SW..) 1 pc

Values in brackets are for single phase version.

Options (extra ordered)

- 140-50 Current coil 25 and 50 turns up to 1000A
- 151-25 Current coil 25 turns up to 2250A
- Option 10 Test lead 32A/1000V (black)
- Option 11 Test lead 32A/1000V (red)
- Option 12 Test lead 32A/1000V (blue)
- Option 13 Test lead 32A/1000V (yellow)
- IEEE488/IEEE488 GPIB cable, 2m
- Power Specialized application SW for transducers calibration.
- Caliber Universal application SW for instruments calibration.

Manufacturer

MEATEST, spol.s r.o

Zelezna 509/3, 619 00 Brno

Czech Republic

tel: +420 543 250 886

fax: +420 543 250 890

meatest@meatest.cz

www.meatest.com



According to EN ISO/IEC 17050-1:2010 standard as well as 2014/30/EU and 2014/35/EU directives of European Parliament and European Council, MEATEST, spol. s r. o., manufacturer of M133C Electric Power/Energy Calibrator based in Železná 3, 619 00 Brno, Czech Republic, declares that its product conforms to following specifications:

Safety requirements

- EN 61010-1 ed. 2:2010 + A1:2016 + COR1:2019-03

Electromagnetic compatibility

- EN 61000 part 3-2 ed. 5:2019
- EN 61000 part 3-3 ed. 3:2014
- EN 61000 part 4-2 ed. 2:2009
- EN 61000 part 4-3 ed. 3:2006 +A1:2008+A2:2011+Z1:2010
- EN 61000 part 4-4 ed. 3:2013
- EN 61000 part 4-5 ed. 3:2015 + A1:2018
- EN 61000 part 4-6 ed. 4:2014
- EN 61000 part 4-11 ed. 2:2005
- EN 61326-1 ed. 2:2013

Brno

September 25th, 2020A handwritten signature in blue ink, appearing to read 'Klemm', is written over the signature line.

Place

Date

Signature